

Technical Chip Distributor for ADI Die Products

Application Support

- Design Assistance
- Assembly Assistance
- Die handling consultancy
- Hi-Rel die qualification
- Hot & Cold die probing
- Electrical test & trimming

Distributed Product Support

- Customised Pack Sizes / Qtys
- Support for all industry recognised supply formats:
 - Waffle Pack
 - Gel Pak
 - Tape & Reel
- Onsite storage, stockholding & scheduling

Product Quality Assurance

- 100% Visual Inspection
 - MIL-STD 883 Condition A
 - MIL-STD 883 Condition A
- On-site failure analysis
- Bespoke 24 Hour monitored storage systems for secure long term product support
- On-site failure analysis

Contact

baredie@micross.com

For price, delivery and to place orders

[HMC292](#)

Analog Devices Welcomes Hittite Microwave Corporation

NO CONTENT ON THE ATTACHED DOCUMENT HAS CHANGED

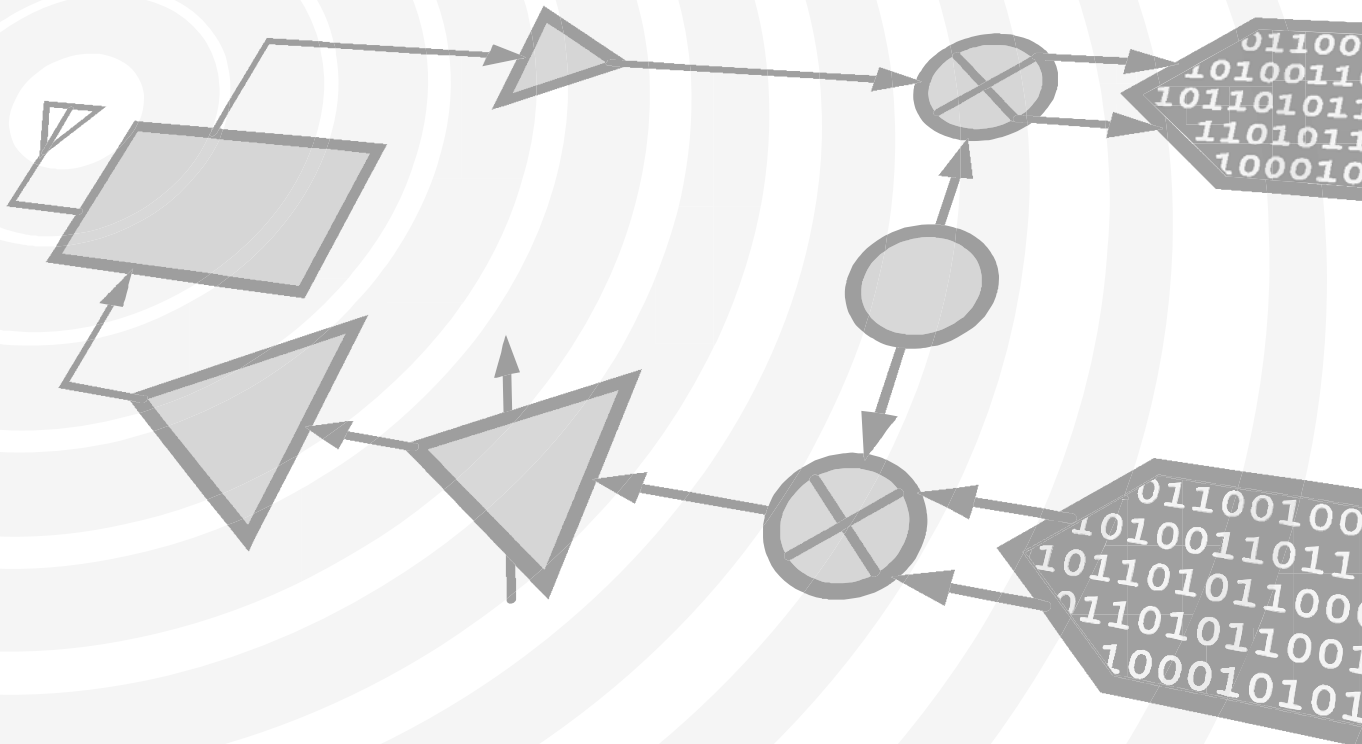

THIS PAGE INTENTIONALLY LEFT BLANK



GaAs MMIC DOUBLE-BALANCED MIXER, 18 - 32 GHz

Typical Applications

The HMC292 is ideal for:

- Microwave Point-to-Point Radios
- LMDS
- SATCOM

Features

- Input IP3: +19 dBm
- LO / RF Isolation: 38 dB
- Passive: No DC Bias Required
- Small Size: 1.04 x 0.58 x 0.1 mm

Functional Diagram

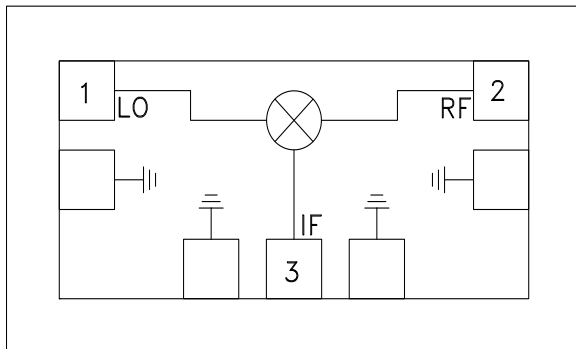

General Description

The HMC292 chip is a miniature passive GaAs MMIC double-balanced mixer which can be used as an upconverter or downconverter from 18 - 32 GHz in a small chip area of 0.66 mm². Excellent isolations are provided by on-chip baluns, which require no external components and no DC bias. All data is measured with the chip in a 50 ohm test fixture connected via 0.076 mm (3 mil) ribbon bonds of minimal length <0.31 mm (<12 mils).

Electrical Specifications, $T_A = +25^\circ\text{C}$

| Parameter | LO = +13 dBm | | | LO = +13 dBm | | | Units |
|-------------------------------|--------------|------|------|--------------|------|------|-------|
| | Min. | Typ. | Max. | Min. | Typ. | Max. | |
| Frequency Range, RF & LO | 20 - 30 | | | 18 - 32 | | | GHz |
| Frequency Range, IF | DC - 8 | | | DC - 8 | | | GHz |
| Conversion Loss | | 7.5 | 9.5 | | 9 | 11 | dB |
| Noise Figure (SSB) | | 7.5 | 9.5 | | 9 | 11 | dB |
| LO to RF Isolation | 30 | 38 | | 30 | 38 | | dB |
| LO to IF Isolation | 31 | 40 | | 28 | 40 | | dB |
| RF to IF Isolation | 20 | 24 | | 17 | 24 | | dB |
| IP3 (Input) | 17 | 19 | | 15 | 19 | | dB |
| IP2 (Input) | 45 | 50 | | 42 | 50 | | dBm |
| 1 dB Gain Compression (Input) | 8 | 12 | | 8 | 12 | | dBm |



Conversion Gain vs. Temperature @ LO = +13 dBm

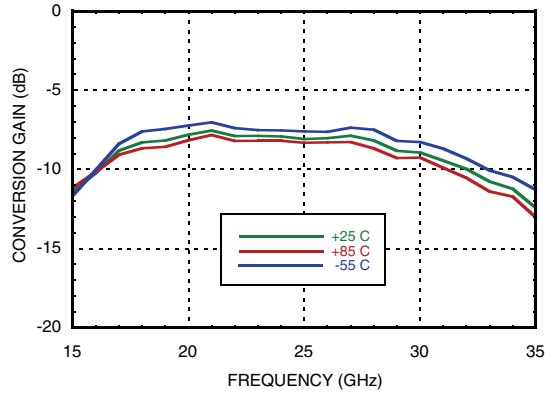

GAAs MMIC DOUBLE-BALANCED MIXER, 18 - 32 GHz

Isolation @ LO = +13 dBm

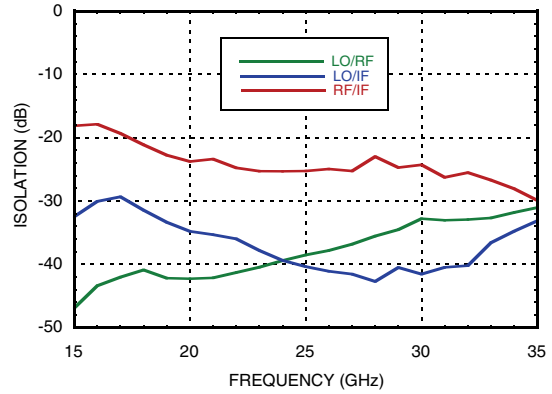

Conversion Gain vs. LO Drive

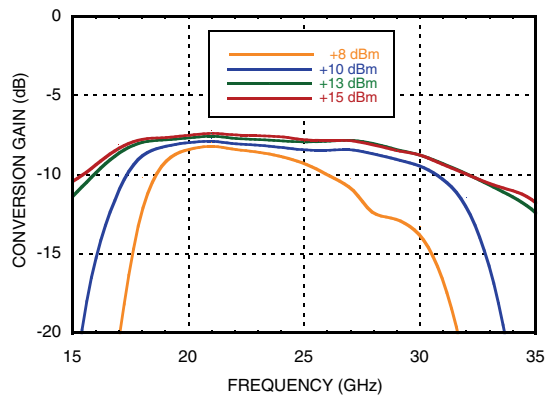

RF & LO Return Loss @ LO = +13 dBm

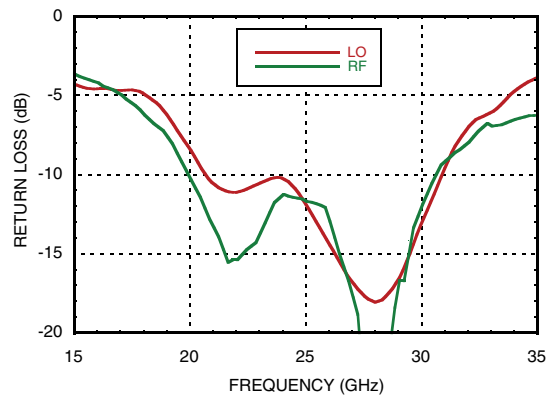

IF Bandwidth @ LO = +13 dBm

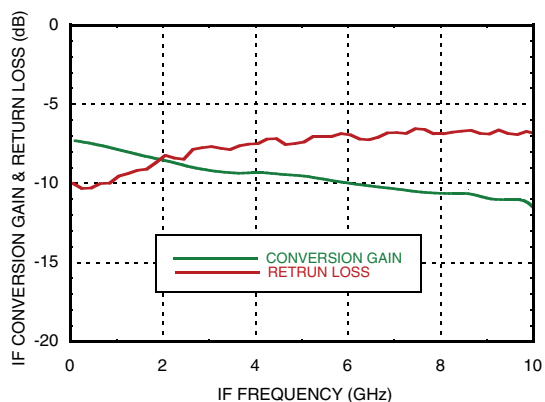

Upconverter Performance Conversion Gain @ LO = +13 dBm

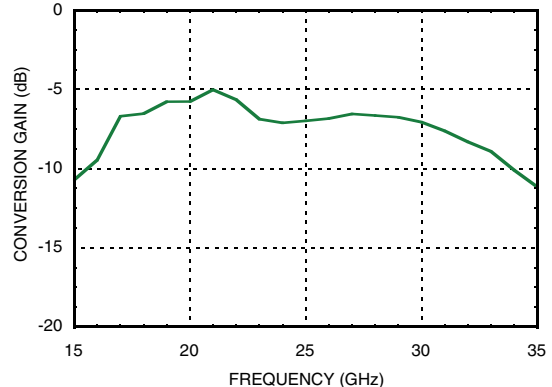



GAAs MMIC DOUBLE-BALANCED MIXER, 18 - 32 GHz

MIXERS - DOUBLE-BALANCED - CHIP

Input IP3 vs. LO Drive

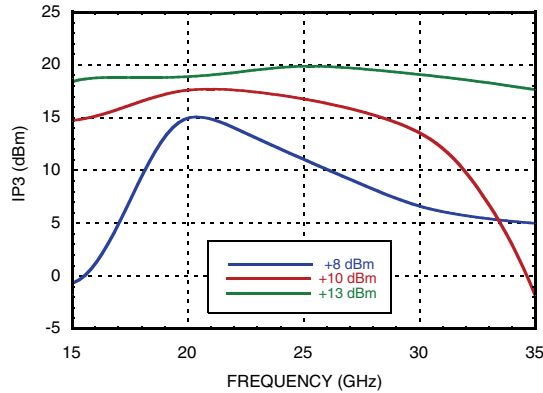

Input IP3 vs. Temperature @ LO = +13 dBm

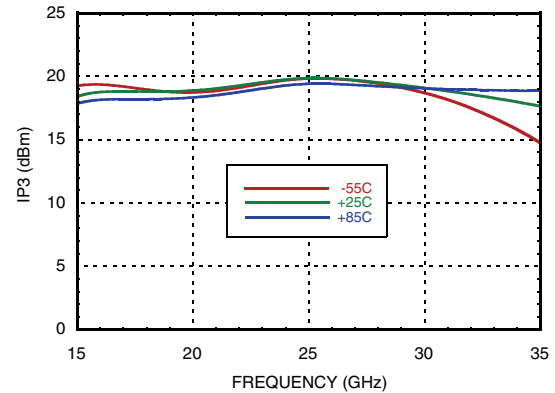

Input IP2 vs. LO Drive

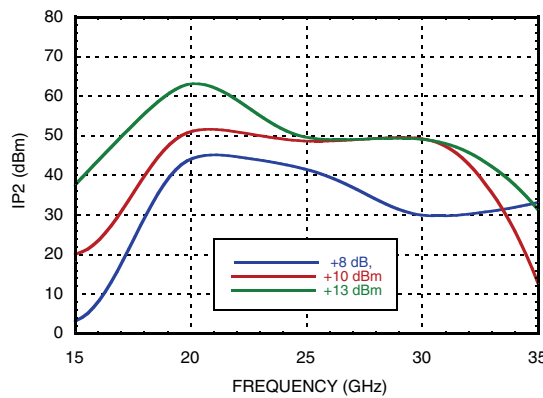

Input IP2 vs. Temperature @ LO = +13 dBm

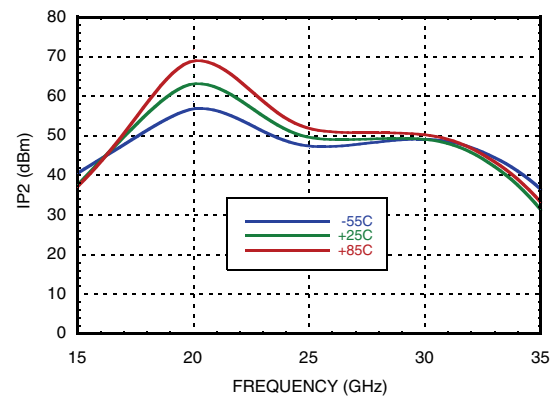

Input P1dB vs. Temperature @ LO = +13 dBm

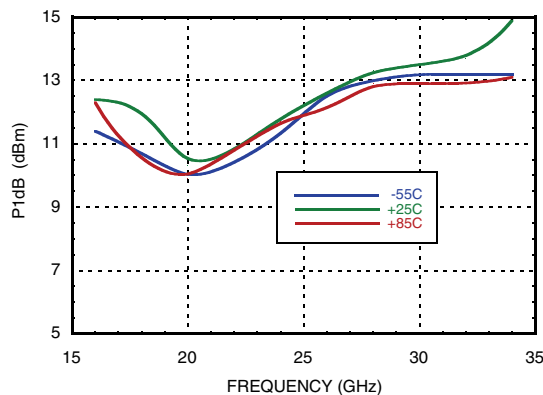

MxN Spurious Outputs

| mRF | nLO | | | | |
|-----|-----|----|------|------|------|
| | 0 | 1 | 2 | 3 | 4 |
| 0 | xx | 11 | | | |
| 1 | 17 | 0 | 39 | | |
| 2 | | 70 | 77 | 76 | |
| 3 | | | 93 | 69 | 86 |
| 4 | | | >110 | >110 | >110 |

RF = 21 GHz @ -10 dBm
 LO = 22 GHz @ +13 dBm
 All values in dBc below the IF power level.

**GAAs MMIC DOUBLE-BALANCED
MIXER, 18 - 32 GHz**
Absolute Maximum Ratings

| | |
|---|----------------|
| RF / LO Total Power | +24 dBm |
| IF Input | +16 dBm |
| Channel Temperature | 150 °C |
| Continuous Pdiss (Ta=85 °C) (derate 4 mW/°C above 85 °C) | 260 mW |
| Thermal Resistance (R _{TH}) (junction to die bottom) | 250 °C/W |
| Storage Temperature | -65 to +150 °C |
| Operating Temperature | -55 to +85 °C |
| ESD Sensitivity (HBM) | Class 1C |

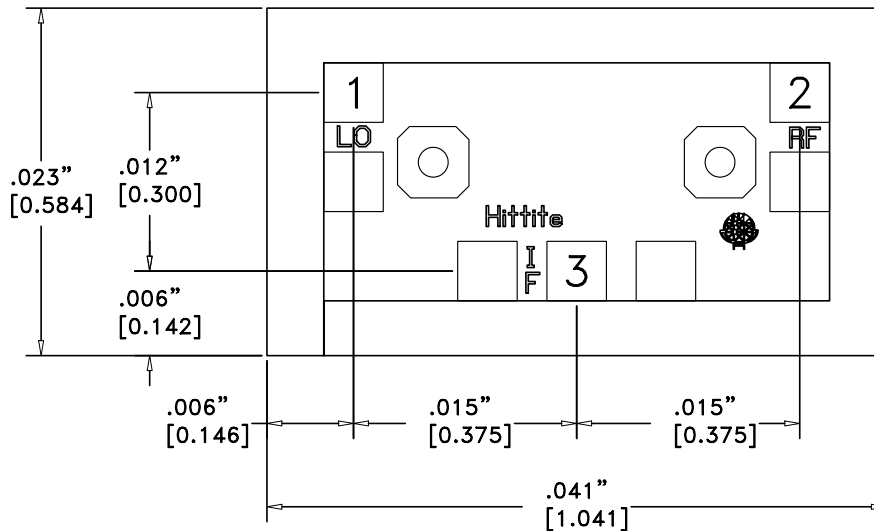
**ELECTROSTATIC SENSITIVE DEVICE
OBSERVE HANDLING PRECAUTIONS**
Outline Drawing

Die Packaging Information [1]

| Standard | Alternate |
|-----------------|-----------|
| GP-5 (Gel Pack) | [2] |



[1] Refer to the "Packaging Information" section for die packaging dimensions.

[2] For alternate packaging information contact Hittite Microwave Corporation.

NOTES:

1. ALL DIMENSIONS ARE IN INCHES [MM].
2. DIE THICKNESS IS .004".
3. TYPICAL BOND PAD IS .004" SQUARE.
4. BACKSIDE METALLIZATION: GOLD.
5. BOND PAD METALLIZATION: GOLD.
6. BACKSIDE METAL IS GROUND.
7. CONNECTION NOT REQUIRED FOR UNLABELED BOND PADS.

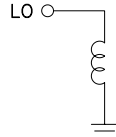
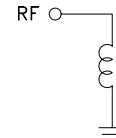
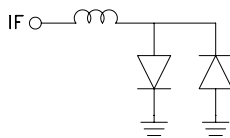
**GAAs MMIC DOUBLE-BALANCED
MIXER, 18 - 32 GHz**
Pad Descriptions

| Pad Number | Function | Description | Interface Schematic |
|------------|----------|---|--|
| 1 | LO | This pin is DC coupled and matched to 50 Ohms. |  |
| 2 | RF | This pin is DC coupled and matched to 50 Ohms. |  |
| 3 | IF | This pin is DC coupled. For applications not requiring operation to DC, this port should be DC blocked externally using a series capacitor whose value has been chosen to pass the necessary IF frequency range. For operation to DC, this pin must not source/sink more than 2 mA of current or die non-function and possible die failure will result. |  |
| Die Bottom | GND | Die bottom must be connected to RF/DC ground. |  |

**GAAs MMIC DOUBLE-BALANCED
MIXER, 18 - 32 GHz**
Mounting & Bonding Techniques for Millimeterwave GaAs MMICs

The die should be attached directly to the ground plane eutectically or with conductive epoxy (see HMC general Handling, Mounting, Bonding Note).

50 Ohm Microstrip transmission lines on 0.127mm (5 mil) thick alumina thin film substrates are recommended for bringing RF to and from the chip (Figure 1). If 0.254mm (10 mil) thick alumina thin film substrates must be used, the die should be raised 0.150mm (6 mils) so that the surface of the die is coplanar with the surface of the substrate. One way to accomplish this is to attach the 0.102mm (4 mil) thick die to a 0.150mm (6 mil) thick molybdenum heat spreader (moly-tab) which is then attached to the ground plane (Figure 2).

Microstrip substrates should be brought as close to the die as possible in order to minimize ribbon bond length. Typical die-to-substrate spacing is 0.076mm (3 mils). Gold ribbon of 0.075 mm (3 mil) width and minimal length <0.31 mm (<12 mils) is recommended to minimize inductance on RF, LO & IF ports.

Handling Precautions

Follow these precautions to avoid permanent damage.

Storage: All bare die are placed in either Waffle or Gel based ESD protective containers, and then sealed in an ESD protective bag for shipment. Once the sealed ESD protective bag has been opened, all die should be stored in a dry nitrogen environment.

Cleanliness: Handle the chips in a clean environment. DO NOT attempt to clean the chip using liquid cleaning systems.

Static Sensitivity: Follow ESD precautions to protect against ESD strikes.

Transients: Suppress instrument and bias supply transients while bias is applied. Use shielded signal and bias cables to minimize inductive pick-up.

General Handling: Handle the chip along the edges with a vacuum collet or with a sharp pair of bent tweezers. The surface of the chip has fragile air bridges and should not be touched with vacuum collet, tweezers, or fingers.

Mounting

The chip is back-metallized and can be die mounted with AuSn eutectic preforms or with electrically conductive epoxy. The mounting surface should be clean and flat.

Eutectic Die Attach: A 80/20 gold tin preform is recommended with a work surface temperature of 255 °C and a tool temperature of 265 °C. When hot 90/10 nitrogen/hydrogen gas is applied, tool tip temperature should be 290 °C. DO NOT expose the chip to a temperature greater than 320 °C for more than 20 seconds. No more than 3 seconds of scrubbing should be required for attachment.

Epoxy Die Attach: Apply a minimum amount of epoxy to the mounting surface so that a thin epoxy fillet is observed around the perimeter of the chip once it is placed into position. Cure epoxy per the manufacturer's schedule.

Wire Bonding

RF bonds made with 0.003" x 0.0005" ribbon are recommended. These bonds should be thermosonically bonded with a force of 40-60 grams. DC bonds of 0.001" (0.025 mm) diameter, thermosonically bonded, are recommended. Ball bonds should be made with a force of 40-50 grams and wedge bonds at 18-22 grams. All bonds should be made with a nominal stage temperature of 150 °C. A minimum amount of ultrasonic energy should be applied to achieve reliable bonds. All bonds should be as short as possible, less than 12 mils (0.31 mm).

