

HBT DRIVER AMPLIFIER DC - 3.0 GHz

FEBRUARY 2001

v00.1100

Features

P1dB Output Power: + 16 dBm

Output IP3: +31 dBm

Single Supply: 8.75V

Ultra Small SOT26 Package



General Description

The HMC323 is a GaAs InGaP Heterojunction Bipolar Transistor (HBT) MMIC amplifier that operates from a single Vcc supply. The surface mount SOT26 amplifier can be used as a broad-band gain stage or used with external matching for optimized narrow band applications. The HMC323 offers 13 dB of gain and +19 dBm of saturated power while only requiring 57 mA from a 8.75V supply. Using a Darlington feedback pair results in reduced sensitivity to normal process variations and provides a good 50-ohm input/output port match. This amplifier is ideal for RF systems where high linearity is required such as 2.2 - 2.7 GHz MMDS.

1

AMPLIFIERS

SMT

Guaranteed Performance, -40 to +60 deg C

Parameter	Vs= 8.75V, RBIAS= 22 Ohm			Units
	Min.	Typ.	Max.	
Frequency Range	DC - 3.0			GHz
Gain @ 25 °C	10	13	16	dB
Gain Variation over Temperature		0.015	0.025	dB/ °C
Input Return Loss	8	13		dB
Output Return Loss	6	9		dB
Reverse Isolation	16	20		dB
Output Power for 1dB Compression (P1dB) @ 1 GHz	13	16		dBm
Saturated Output Power (Psat) @ 1 GHz	16	19		dBm
Output Third Order Intercept (IP3) @ 1 GHz	28	31		dBm
Noise Figure		6		dB
Supply Current (Icc)		57		mA

HBT DRIVER AMPLIFIER DC - 3.0 GHz

v00.1100

FEBRUARY 2001

Gain & Return Loss

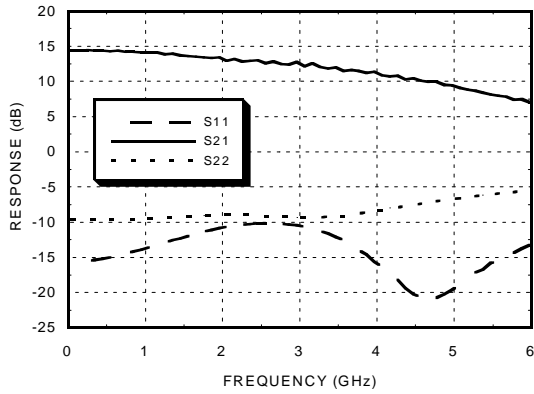

Gain vs. Temperature

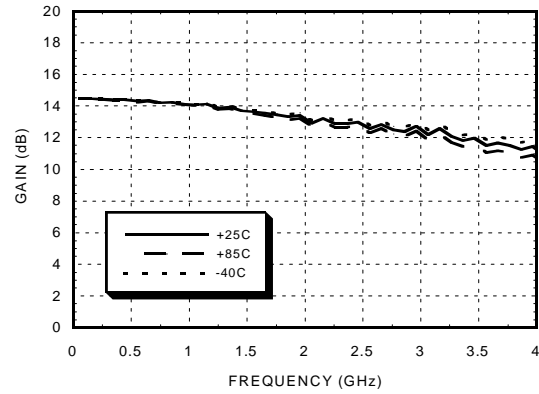

Input Return Loss vs. Temperature

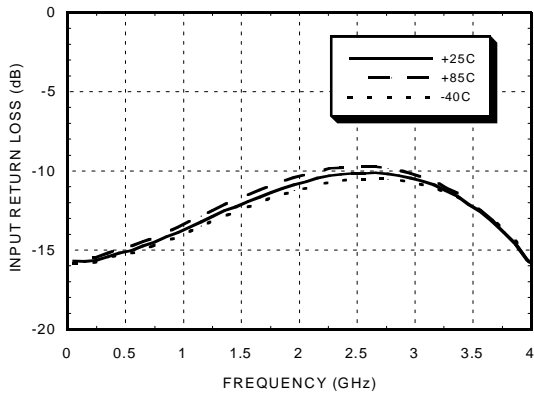

Output Return Loss vs. Temperature

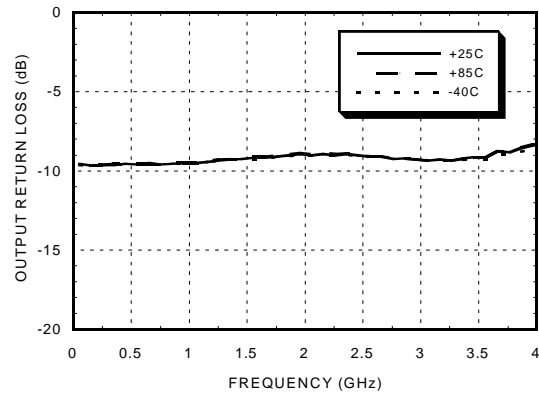

Reverse Isolation vs. Temperature

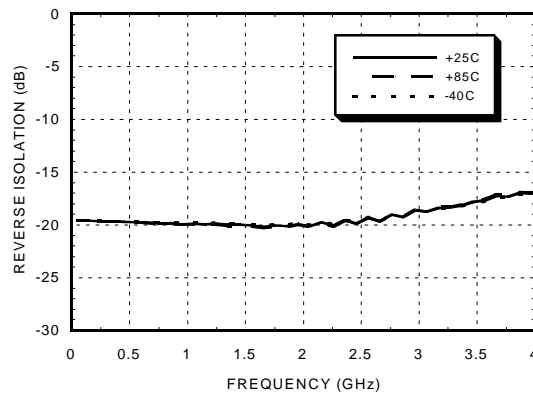

1

AMPLIFIERS

SMT



HBT DRIVER AMPLIFIER DC - 3.0 GHz

FEBRUARY 2001

v00.1100

1
AMPLIFIERS
SMT

P1dB vs. Temperature

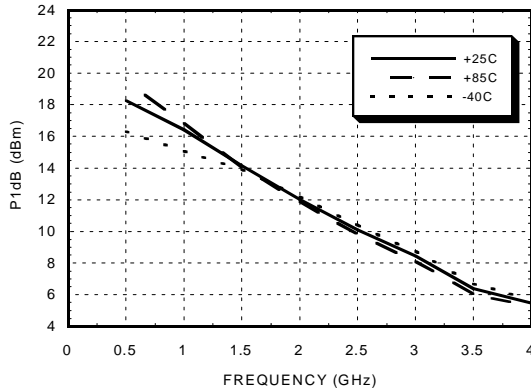

Psat vs. Temperature

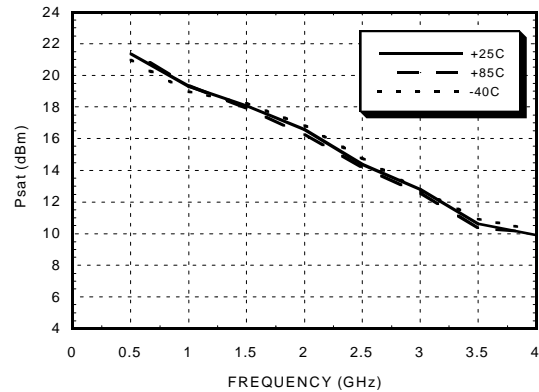

Power Compression @ 1 GHz

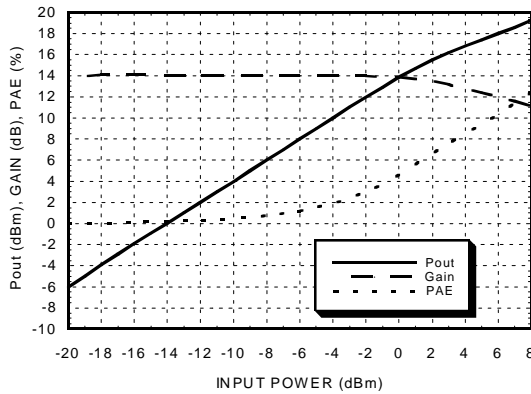

Power Compression @ 2 GHz

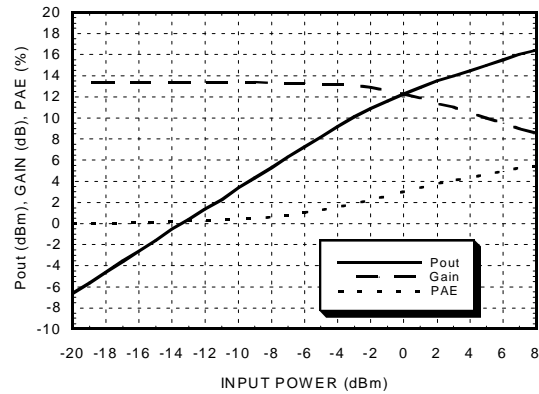

Output IP3 vs. Temperature

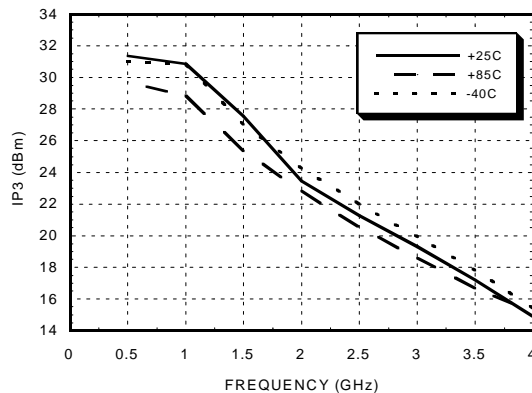

HBT DRIVER AMPLIFIER DC - 3.0 GHz

v00.1100

FEBRUARY 2001

Schematic

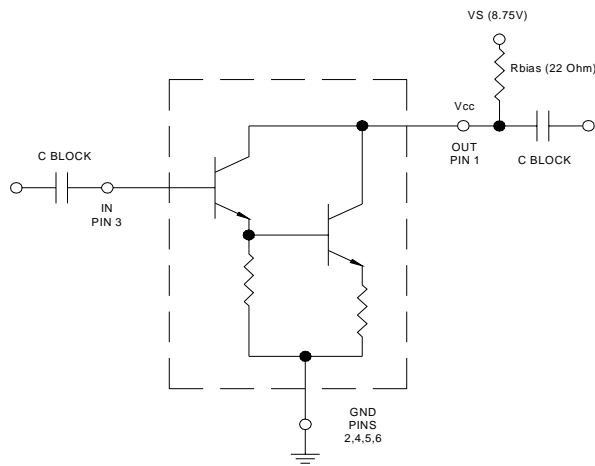

Absolute Maximum Ratings



DC Voltage on Pin 1	8 Volts
Input Power (RFin)(Vcc = +5V)	+20 dBm
Channel Temperature (Tc)	175 °C
Continuous P _{diss} (Ta= 60 °C) (derate 4.41 mW/ °C above 60 °C)	507 mW
Storage Temperature	-65 to +150 °C
Operating Temperature	-55 to +60 °C

Note:

1. Select R_{BIAS} to achieve desired V_{cc} voltage on Pin 1.
2. External blocking capacitors are required on Pins 1 and 3.

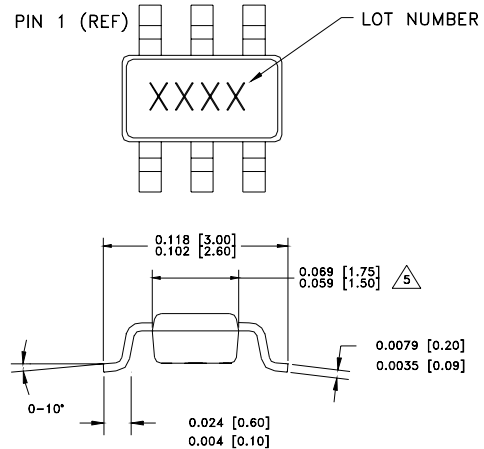
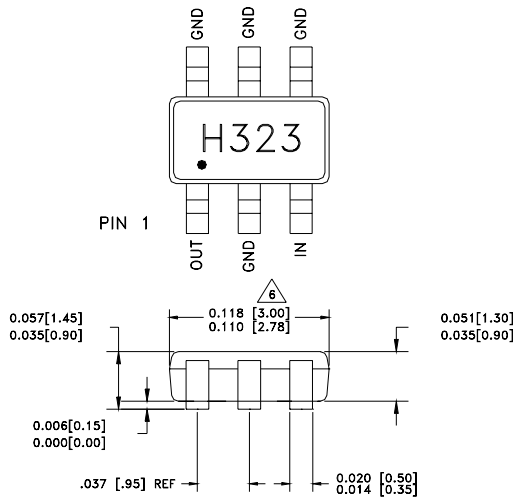
Outline



- | | |
|---|---|
| <ol style="list-style-type: none"> 1. MATERIAL: <ul style="list-style-type: none"> A) PACKAGE BODY - LOW STRESS INJECTION-MOLDED PLASTIC. B) LEADFRAME & PADDLE MATERIAL: COPPER ALLOY 2. PLATING : LEAD & PADDLE- TIN SOLDER PLATE 3. DIMENSIONS ARE IN INCHES (MILLIMETERS).
UNLESS OTHERWISE SPECIFIED ALL TOL. ARE ±0.005(±0.13). |  CHARACTERS TO HELVETICA MEDIUM, .020 HIGH
 DIMENSION DOES NOT INCLUDE MOLDFLASH OF 0.15 MM PER SIDE
 DIMENSION DOES NOT INCLUDE MOLDFLASH OF 0.25 MM PER SIDE |
|---|---|

1
AMPLIFIERS
SMT



HBT DRIVER AMPLIFIER DC - 3.0 GHz

FEBRUARY 2001

v00.1100

Evaluation PCB for HMC323

1
SMT AMPLIFIERS

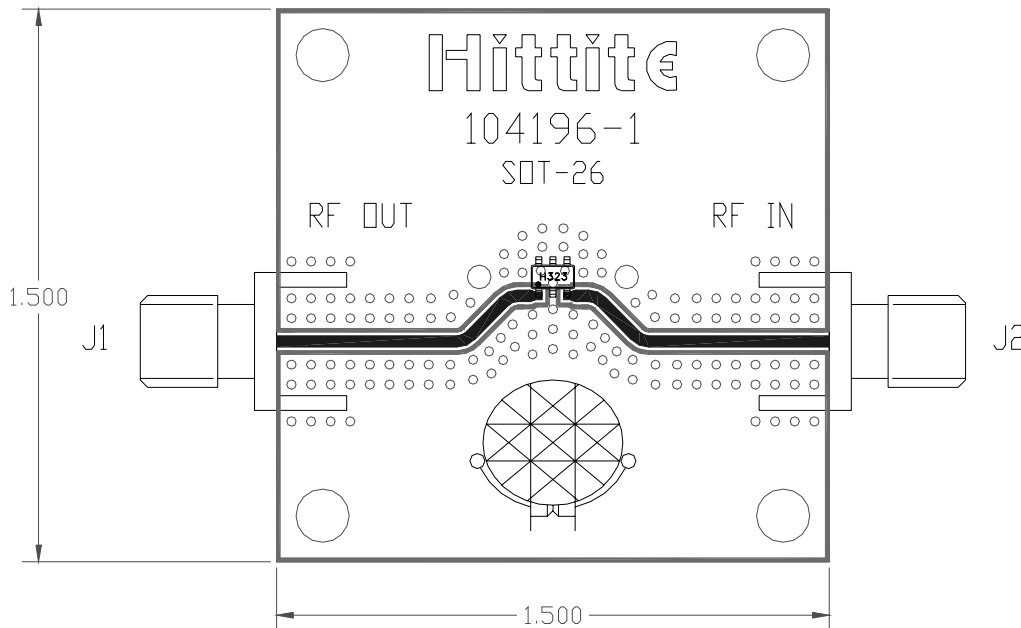
The circuit board used in the final application should use RF circuit design techniques. Signal lines should have 50 ohm impedance while the package ground leads and exposed paddle should be connected directly to the ground plane similar to that shown above. A sufficient number of VIA holes should be used to connect the top and bottom ground planes. The evaluation circuit board as shown is available from Hittite upon request.

Evaluation Circuit Board Layout Design Details

Item	Description
J1 - J2	PC Mount SMA Connector
U1	HMC323
PCB*	104196 Evaluation PCB 1.5" x 1.5"
*Circuit Board Material: Rogers 4350	

HBT DRIVER AMPLIFIER DC - 3.0 GHz

v00.1100

FEBRUARY 2001

NOTES:

1
AMPLIFIERS
SMT
