

## GaAs InGaP HBT MMIC DUAL DRIVER AMPLIFIER, DC - 3.0 GHz

### Typical Applications

This Amplifier is ideal for RF Systems where high linearity is required such as:

- CATV Head-End and Modem
- Cellular & Base Stations
- MMDS
- WirelessLAN

### Functional Diagram

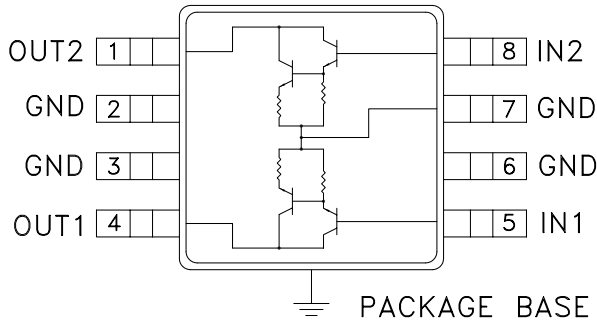

### Features

- P1dB Output Power: +16 dBm
- Output IP3: +30 dBm
- Gain: 13 dB
- Single Supply: 8.75V
- Ultra Small Package: MSOP8G

### General Description

The HMC324MS8G is a high efficiency GaAs InGaP Heterojunction Bipolar Transistor (HBT) MMIC amplifier that contains two non-connected amplifiers in parallel inside an 8 lead MSOPG package. When used in conjunction with an external balun, the outputs of the amplifier can be combined to reduce the 2nd harmonic distortion that is generated by the amplifier. With Vcc at +7.5V, the HMC324MS8G offers 13 dB of gain and with power combining and harmonic cancellation, +24 dBm of output power can be achieved. Using a Darlington feedback pair results in reduced sensitivity to normal process variations and provides a good 50-ohm input/output port match. This amplifier is ideal for RF systems where high linearity is required and can operate in 50-ohm and 75-ohm systems.

### Electrical Specifications, $T_A = +25^\circ C$

Parameter	Vs= +8.75V, Rbias= 22 Ohm			Units
	Min.	Typ.	Max.	
Frequency Range	DC - 3.0			GHz
Gain	10	13	16	dB
Gain Variation Over Temperature		0.015	0.025	dB/ °C
Input Return Loss	10	15		dB
Output Return Loss	6	9		dB
Reverse Isolation	16	20		dB
Output Power for 1dB Compression (P1dB) @ 1 GHz	13	16		dBm
Saturated Output Power (Psat) @ 1 GHz	18	21		dBm
Output Third Order Intercept (IP3) @ 1 GHz	27	30		dBm
Noise Figure		6		dB
Supply Current (Icc)		57		mA

Note: All specifications refer to a single amplifier.

## GaAs InGaP HBT MMIC DUAL DRIVER AMPLIFIER, DC - 3.0 GHz

**Gain & Return Loss**

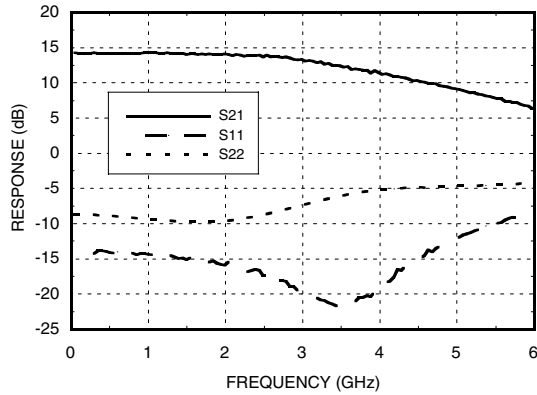

**Gain vs. Temperature**

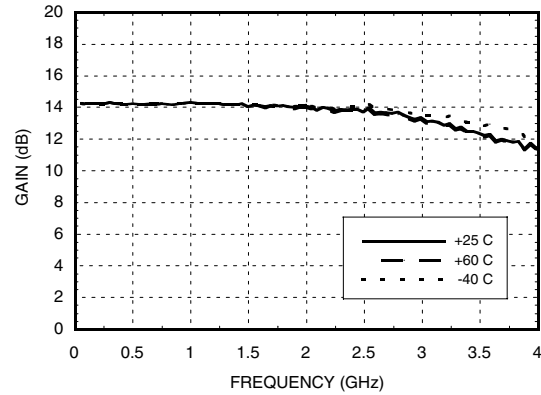

**Input Return Loss vs. Temperature**

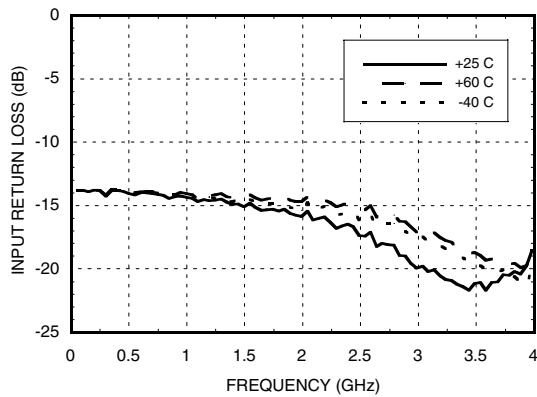

**Output Return Loss vs. Temperature**

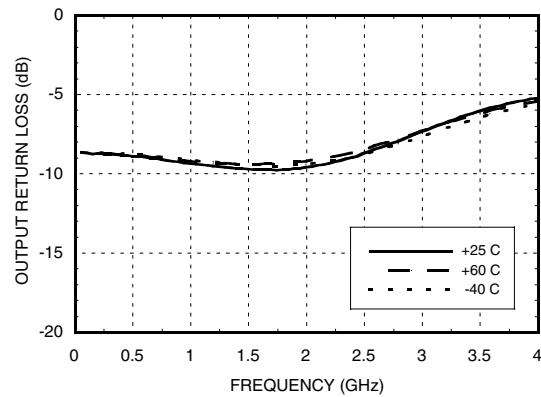

**Reverse Isolation vs. Temperature**

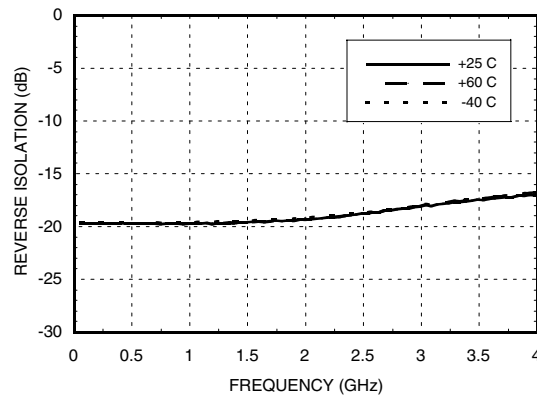

## GaAs InGaP HBT MMIC DUAL DRIVER AMPLIFIER, DC - 3.0 GHz

1

AMPLIFIERS - SMT

**P1dB vs. Temperature**

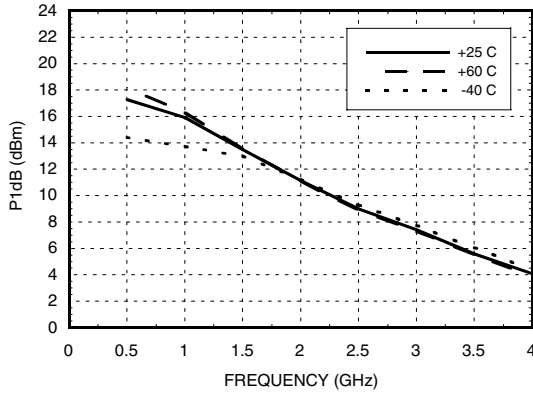

**Psat vs. Temperature**

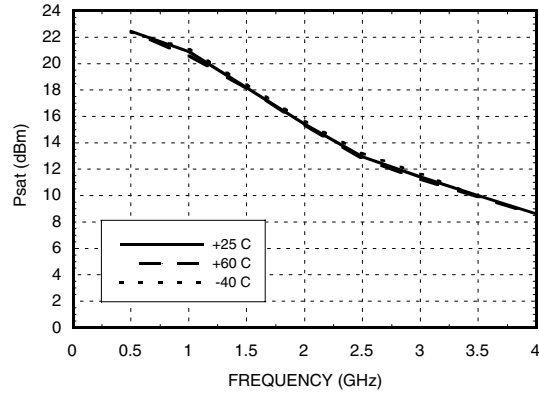

**Power Compression @ 1 GHz**

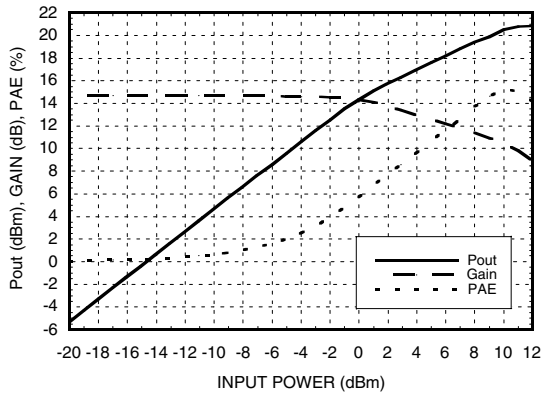

**Power Compression @ 2 GHz**

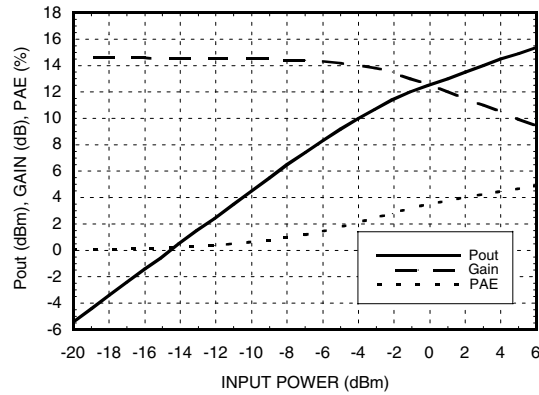

**Output IP3 vs. Temperature**

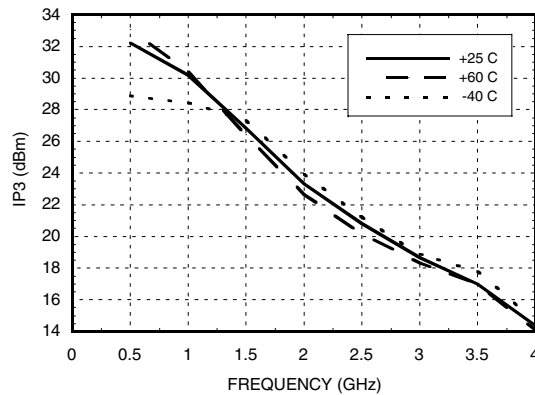

## GaAs InGaP HBT MMIC DUAL DRIVER AMPLIFIER, DC - 3.0 GHz

### Absolute Maximum Ratings

DC Voltage on Pin 1	8 Volts
Input Power (RFin)(Vcc= +5V)	+20 dBm
Channel Temperature (Tc)	150 °C
Continuous P <sub>diss</sub> (T= 85 °C) (derate 4.41 mW/°C above 85 °C)	507 mW
Storage Temperature	-65 to +150° C
Operating Temperature	-40 to +85° C

### Outline Drawing

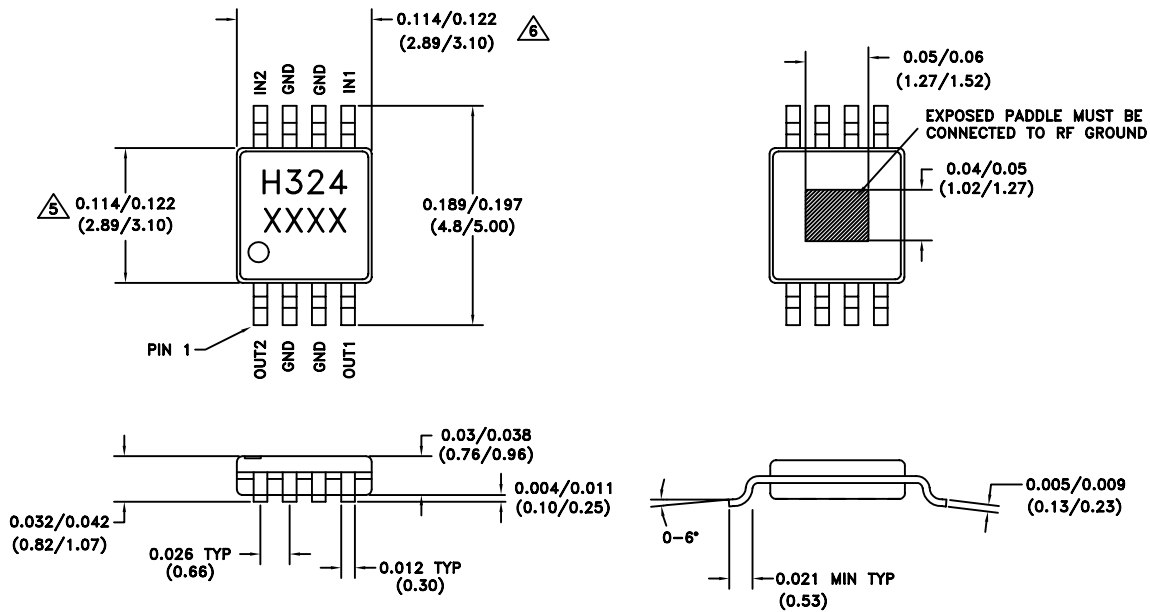

**1. MATERIAL:**

- A. PACKAGE BODY - LOW STRESS INJECTION-MOLDED PLASTIC, SILICA & SILICONE IMPREGNATED.
- B. LEADFRAME MATERIAL: COPPER ALLOY

**2. PLATING: LEAD-TIN SOLDER PLATE**

**3. DIMENSIONS ARE IN INCHES (MILLIMETERS)**

**4. CHARACTERS TO BE HELVETICA MEDIUM, .030 HIGH USING WHITE INK, LOCATED APPROX AS SHOWN**

- 5. DIMENSION DOES NOT INCLUDE MOLDFLASH OF 0.15mm PER SIDE.

- 6. DIMENSION DOES NOT INCLUDE MOLDFLASH OF 0.25mm PER SIDE.

## GaAs InGaP HBT MMIC DUAL DRIVER AMPLIFIER, DC - 3.0 GHz

### Application Circuit

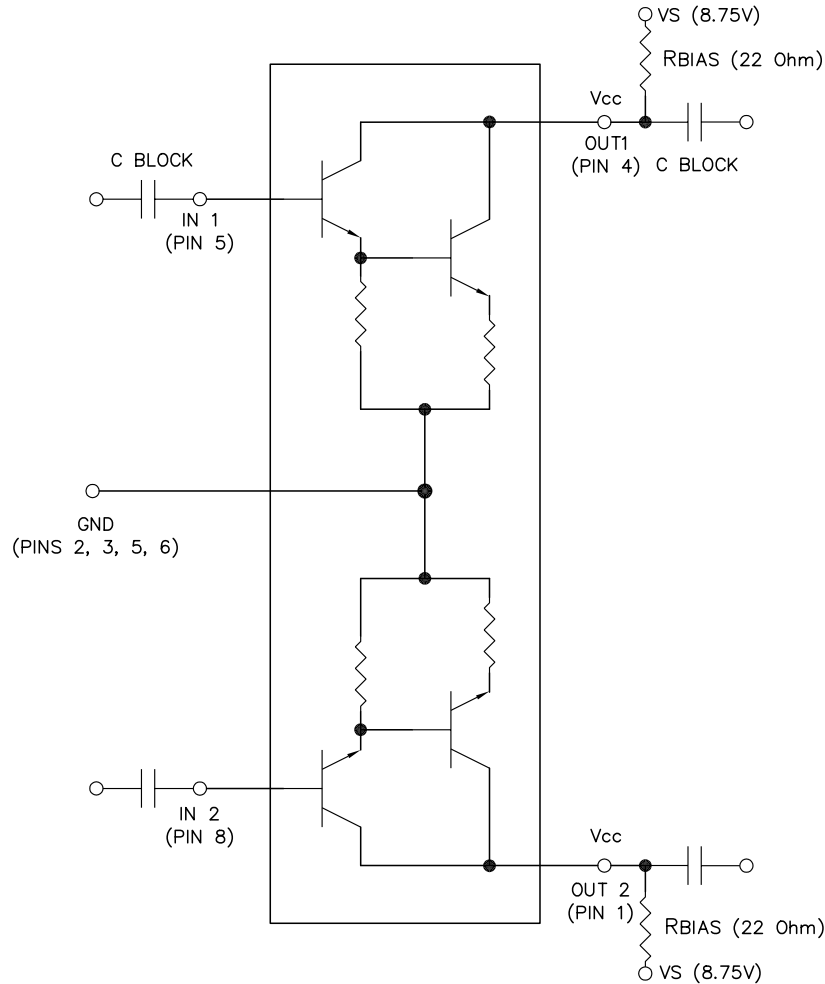

**Note:**

1. Select Rbias to achieve desired Vcc voltage on Pin 1 and 4.
2. External blocking capacitors are required on Pins 1, 4, 5, and 8.

## GaAs InGaP HBT MMIC DUAL DRIVER AMPLIFIER, DC - 3.0 GHz

### Evaluation PCB for HMC324MS8G

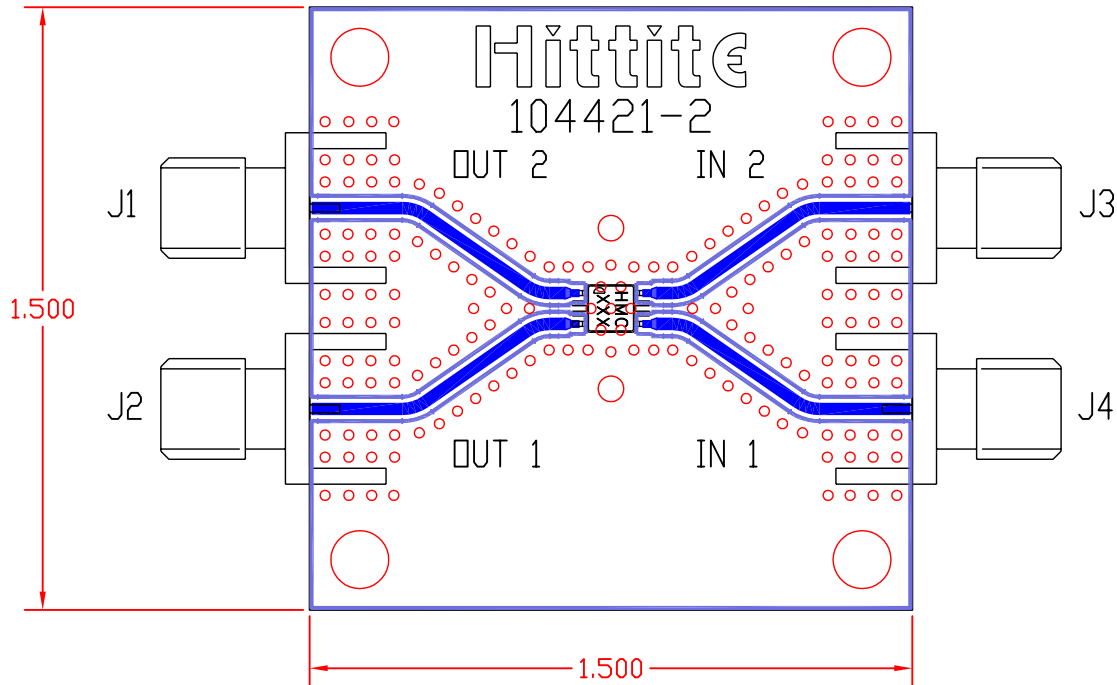

The circuit board used in the final application should use RF circuit design techniques. Signal lines should have 50 ohm impedance while the package ground leads and exposed paddle should be connected directly to the ground plane similar to that shown. A sufficient number of via holes should be used to connect the top and bottom ground planes. The evaluation circuit board shown is available from Hittite upon request.

### Evaluation Circuit Board Layout Design Details

Item	Description
J1 - J4	PC Mount SMA Connector
U1	HMC324MS8G
PCB*	104221 Evaluation PCB 1.5" x 1.5"
* Circuit Board Material: Rogers 4350	