



Product Features

- +37 dBm IIP3
- No External Matching Elements Required
- RF 2200-2300 MHz
- LO 2060-2160 MHz
- IF 50-150 MHz
- +18 dBm Drive Level
- +3V Bias (22 mA)
- Low Cost Surface Mount J-Lead Package

Product Description

The HMJ8 is a high dynamic range, GaAs FET mixer. This active FET mixer realizes a typical third order intercept point of +37 dBm at an LO drive level of +18 dBm. The HMJ8 comes in a low cost, J-lead package. Typical applications include frequency up/down conversion, modulation and demodulation for receivers and transmitters used in communication systems.

Functional Diagram

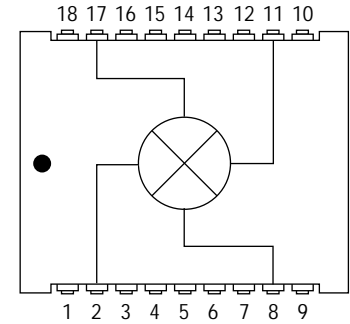

Function	Pin No.	Function	Pin No.
Ground	1	Ground	10
IF	2	LO	11
Ground	3-7	Ground	12-16
+3V DC	8	RF	17
Ground	9	Ground	18

Specifications

Parameter	Units	Minimum	Typical	Maximum	Condition
Frequency Range:					
RF	MHz	2200		2300	
LO	MHz	2060		2160	
IF	MHz	50		150	
SSB Conversion Loss	dB		8	9.0	
Noise Figure	dB		10.5		
Isolation:					
LO-RF	dB	22	27		
LO-IF	dB	22	30		
RF-IF	dB		15		
IIP3	dBm	32	37		
Return Loss:					
RF Port	dB		11		
LO Port	dB		8.5		
IF Port	dB		14		
Input P1dB	dBm		23		
LO Drive Level	dBm		18		
DC Current at +3V Bias	mA		22	35	

Test conditions unless otherwise stated: RF = 2250 MHz (-10 dBm), LO = 2110 MHz (18 dBm), IF = 140 MHz and 25°C.

Absolute Maximum Ratings

Parameter	Rating
Operating Case Temperature	-40 to +85°C
Storage Temperature	-65 to +100°C
Maximum Input Power	25 dBm

1. Operation of this device above any of these parameters may cause permanent damage.
 2. Total sum of LO port and RF port power should not exceed 25 dBm.

Ordering Information

Part No.	Description
HMJ8	High Dynamic Range FET Mixer (Available in tape and reel)
HMJ8-PCB	Fully Assembled Application Circuit

Performance Charts

IIP3 vs. RF Frequency

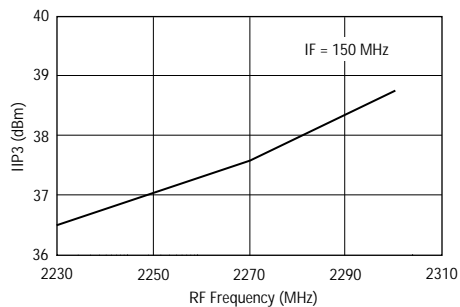

Conversion Loss vs. RF Frequency

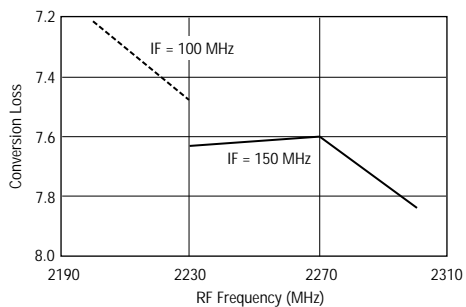

Isolation vs. LO Frequency

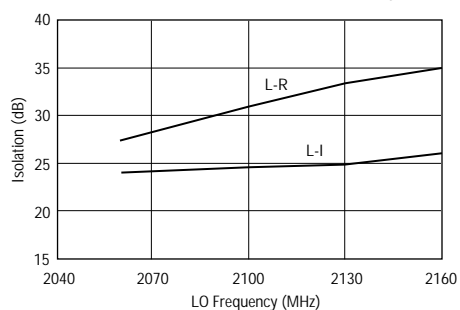

Isolation vs. RF Frequency

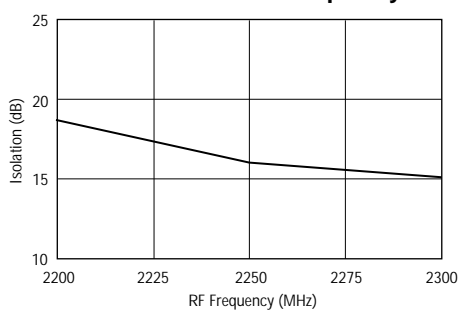

RF Return Loss vs. RF Frequency

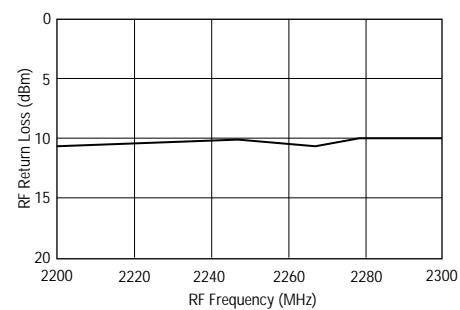

LO Return Loss vs. LO Frequency

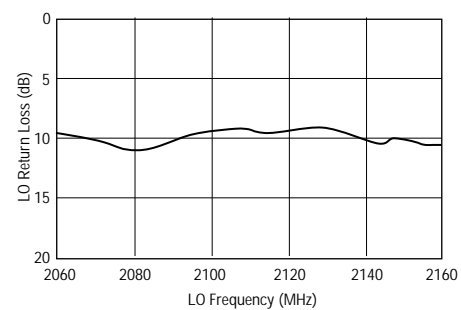

IF Return Loss vs. IF Frequency

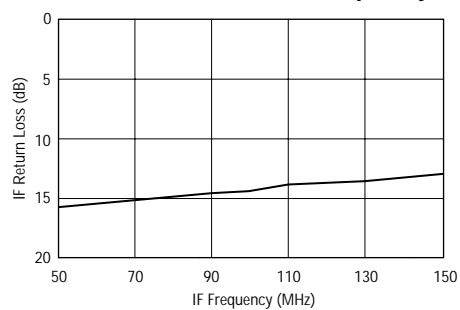

Outline Drawing

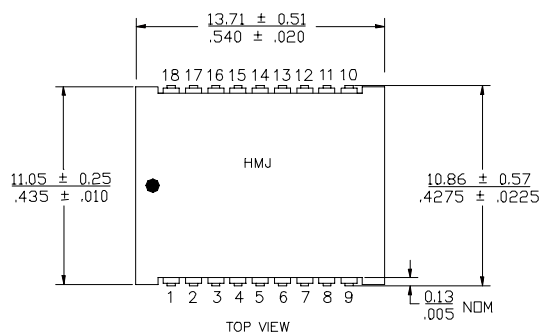

mm
inch

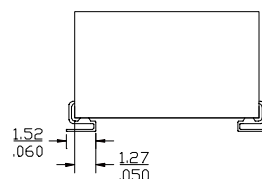
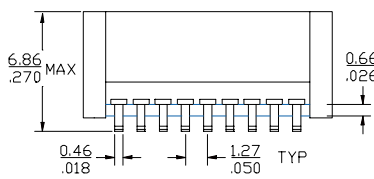

Land Pattern

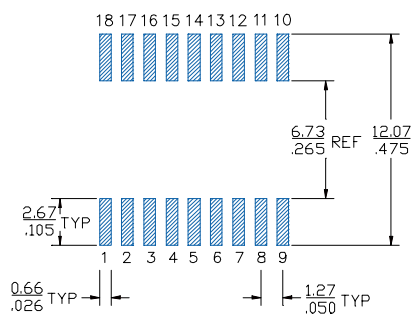

Mounting Configuration

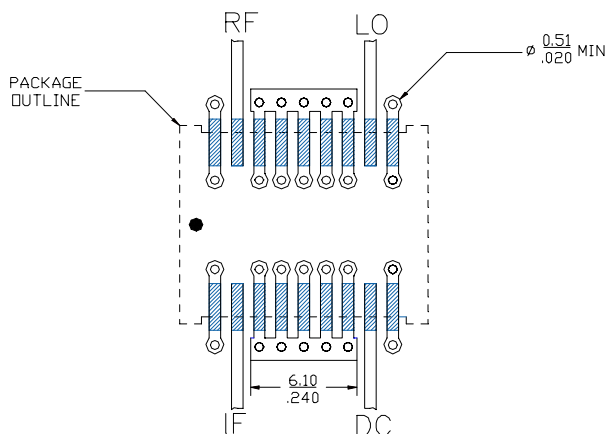

FUNCTION	PIN NO.	FUNCTION	PIN NO.
GROUND	1	GROUND	10
IF	2	LO	11
GROUND	3-7	GROUND	12-16
DC	8	RF	17
GROUND	9	GROUND	18

- Notes:
1. Ground vias are critical for thermal and RF grounding considerations.
 2. A minimum of 28 ground vias are required for 14 mil FR4 board.
 3. If your PCB design rules allow, ground vias should be placed under the land pattern for better RF and thermal performance. Otherwise ground vias should be placed as close to land pattern as possible.
 4. Trace width depends on PC board.



