

*** LAST TIME BUY: AUGUST 31, 2014. CLICK HERE FOR OBSOLESCENCE NOTICE OF FEBRUARY 2014.**



HPR1XXWC Series

0.75 Watt Single Output DC/DC Converter



OBSOLETE PRODUCT

Last time buy: August 31, 2014.

[Click Here For Obsolescence Notice of February 2014.](#)

FEATURES

- Low Cost
- Multiple Package Styles
- Internal Input and Output
- Filtering
- Non-Conductive Case
- High Output Power Density: 10 Watts/Inch³
- Extended Temperature Range: -25°C to +85°C
- Efficiency to 79%
- RoHS Compliant

The HPR1XXWC Series provides a low cost converter without sacrificing reliability. The use of surface mounted devices and advanced manufacturing technologies make it possible to offer premium performance and low cost.

Reduced parts count and high efficiency add to the reliability of the HPR1XXWC Series. The high efficiency of the HPR1XXWC Series means less internal power dissipation, as low as 190mW.

With reduced heat dissipation the HPR1XXWC Series can operate at higher temperatures with no degradation. In addition, the high efficiency of the HPR1XXWC Series means the series is able to offer greater than 10 W/inch³ of output power density. Operation down to no load will not impact the reliability of the series, although a >1mA minimum load is needed to realize published specifications.

The HPR1XXWC Series provides the user a low cost converter without sacrificing reliability. The use of surface mounted devices and advanced manufacturing technologies make it possible to offer premium performance and low cost.

All specifications are typical at TA = +25°C nominal input voltage unless otherwise specified.

*** LAST TIME BUY FOR HPR100WC AND HPR109WC ONLY: AUGUST 31, 2014. CLICK HERE FOR OBSOLESCENCE NOTICE OF FEBRUARY 2014.**

PRODUCT SELECTION CHART

	Model	Nominal Input Voltage	Rated Output Voltage	Rated Output Current	Input Current		Reflected Ripple Current	Efficiency	Recommended Alternatives
					No Load	Rated Load			
					V _{oc}	Typ.			
OBSOLETE *	OBSOLETE HPR100WC	5	5	150	20	216	10	69	NTE0505MC
	OBSOLETE HPR105WC	5	±15	±25	20	200	5	75	NTA0515MC
OBSOLETE *	OBSOLETE HPR109WC	12	±5	±75	10	88	5	71	NTA1205MC
	OBSOLETE HPR101WC	5	12	62	20	212	5	70	NTE0512MC
	OBSOLETE HPR102WC	5	15	50	20	212	5	71	NTE0515MC
	OBSOLETE HPR103WC	5	±5	±75	20	218	5	68	NTA0505MC
	OBSOLETE HPR104WC	5	±12	±30	20	212	5	68	NTA0512MC
	OBSOLETE HPR106WC	12	5	150	10	90	5	69	NTE1205MC
	OBSOLETE HPR107WC	12	12	62	10	81	5	77	NTE1212MC
	OBSOLETE HPR108WC	12	15	50	10	81	5	77	NTE1215MC
	OBSOLETE HPR110WC	12	±12	±30	10	81	5	74	NTA1212MC
	OBSOLETE HPR111WC	12	±15	±25	10	81	5	77	NTA1215MC
	OBSOLETE HPR112WC	15	5	150	8	72	5	69	-
	OBSOLETE HPR113WC	15	12	62	8	72	5	69	-
	OBSOLETE HPR114WC	15	15	50	8	72	5	69	-
	OBSOLETE HPR115WC	15	±5	±75	8	72	5	69	-
	OBSOLETE HPR116WC	15	±12	±30	8	63	5	76	-
	OBSOLETE HPR117WC	15	±15	±25	8	63	5	79	-
	OBSOLETE HPR118WC	24	5	150	8	48	15	65	-
	OBSOLETE HPR119WC	24	12	62	8	48	15	65	-
	OBSOLETE HPR120WC	24	15	50	8	45	15	76	-
	OBSOLETE HPR121WC	24	±5	±75	8	45	15	69	-
	OBSOLETE HPR122WC	24	±12	±30	8	45	15	67	-
	OBSOLETE HPR123WC	24	±15	±25	8	45	15	69	-



For full details go to www.murata-ps.com/rohs

*Not Recommended for New Designs

SPECIFICATIONS, ALL MODELS

Specifications are at $T_A = +25^\circ\text{C}$ nominal input voltage unless otherwise specified.

	PARAMETER	CONDITIONS	MIN	TYP	MAX	UNITS	
INPUT	INPUT						
	Voltage Range		4.5	5	5.5	VDC	
			10.8	12	13.2	VDC	
			13.5	15	16.5	VDC	
			21.6	24	26.4	VDC	
	Voltage Rise Time See Typical Performance Curves & Application Notes: "Capacitive Loading Effects on Start-Up of DC/DC Converters"						
OUTPUT	OUTPUT						
	Rated Power				750	mW	
	Voltage Setpoint Accuracy	Rated Load, Nominal V_{IN}			± 5	%	
	Ripple & Noise	BW = DC to 10MHz			150	200	mVp-p
		BW = 10Hz to 2MHz			30	40	mVrms
	Voltage (Over Input Voltage Range)	1mA to Rated Current, $V_{OUT} = 5V$		4.75		7	VDC
		1mA to Rated Current, $V_{OUT} = 12V$		11.40		15	VDC
		1mA to Rated Current, $V_{OUT} = 15V$		14.25		18	VDC
	Temperature Coefficient			.01	.05	%/°C	
	REGULATION						
Load Regulation (All other modes)	Rated Load to 1mA Load			3		%	
GENERAL	GENERAL ISOLATION						
	Rated Voltage		750			VDC	
	Test Voltage	60 Hz, 10 Seconds	750			Vrms	
	Resistance		10			GΩ	
	Capacitance			25	100	pF	
	Leakage Current	$V_{ISO} = 240\text{VAC}, 60\text{Hz}$		2	8.5	μArms	
	Switching Frequency			170		kHz	
	Frequency Change	Over Line and Load		24		%	
	Package Weight				3	g	
	MTTF per MIL-HDBK-217, Rev. F*	Circuit Stress Method					
	Ground Benign	$T_A = +25^\circ\text{C}$		7.9		MHr	
	Fixed Ground	$T_A = +35^\circ\text{C}$		1.9		MHr	
	Naval Sheltered	$T_A = +35^\circ\text{C}$		1.2		MHr	
	Airborne Uninhabited Fighter	$T_A = +35^\circ\text{C}$		300		kHr	
	TEMPERATURE						
Specification			-25	+25	+85	°C	
Operation			-40		+100	°C	
Storage			-40		+110	°C	

SOLDERING INFORMATION

The surface mount versions of the HPR1XXWC series are designed for SMT reflow soldering. During this standard process devices should be heated at a rate not to exceed 3 degrees C per second. The peak reflow temperature is 260 degrees C. The device should not be exposed to the peak temperature ± 10 degrees C for more than 12 seconds. The cool down rate for this device should not exceed 3 degrees C per second.

TYPICAL PERFORMANCE CURVES

Specifications are at $T_A = +25^\circ\text{C}$ nominal input voltage and nominal load.

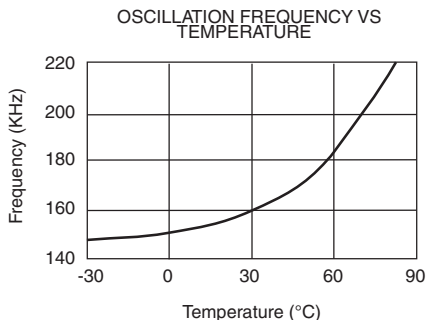
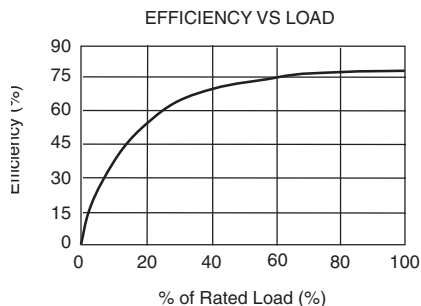
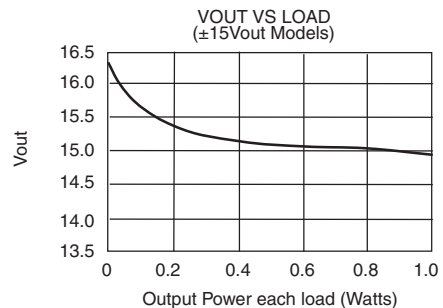
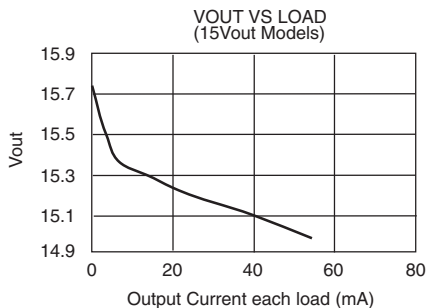
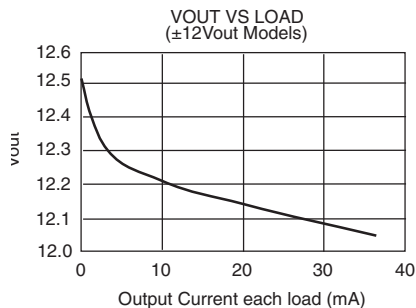
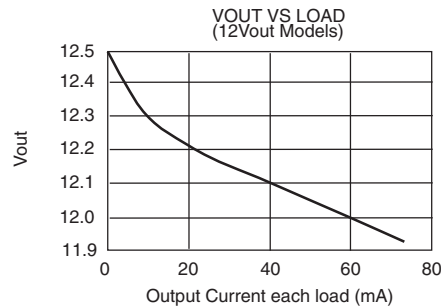
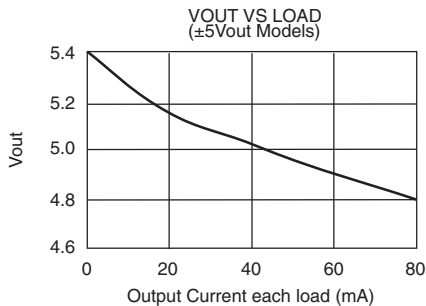
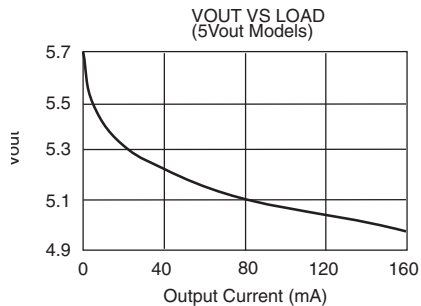

SAFE OPERATING AREA

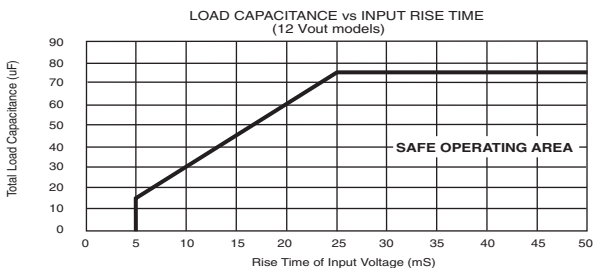
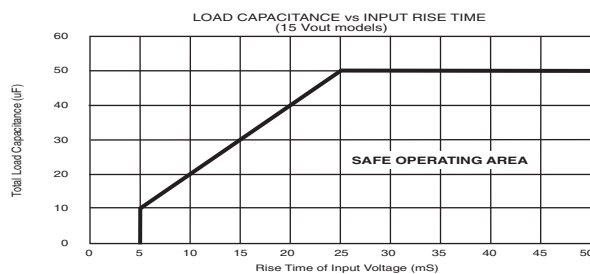
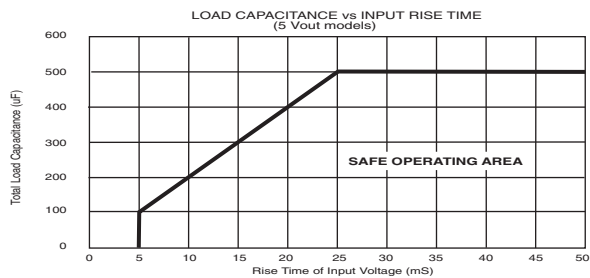

NOTES:

- 1.) When operated within the SAFE OPERATING AREA as defined by the above curves, the output voltage of HPR1XXC devices is guaranteed to be within 95% of its steady-state value within 100 milliseconds after the input voltage has reached 95% of its steady-state value.
- 2.) For dual output models, total load capacitance is the sum of the capacitances on the plus and minus outputs.

MECHANICAL

PACKAGE/PINOUT "W"
SMD PACKAGE

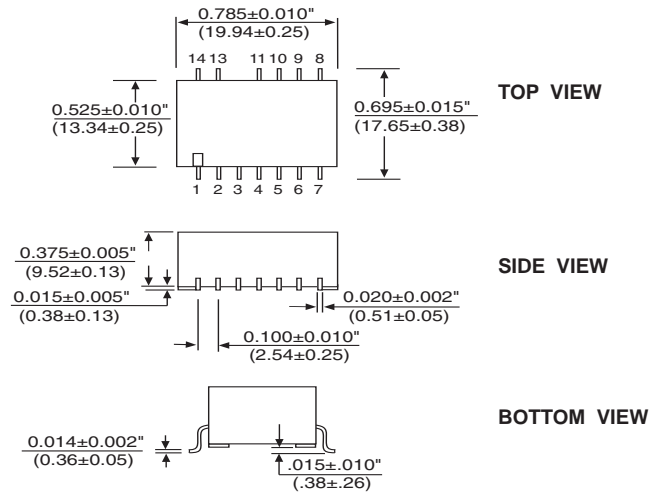

PIN CONNECTIONS

PIN#	SINGLES	DUALS	PIN#	SINGLES	DUALS
1	+VIN	+VIN	7	+VOUT	+VOUT
2	-VIN	-VIN	8	NC	NC
3	NC	NC	9	NC	NC
4	NC	NC	10	NC	NC
5	-VOUT	-VOUT	11	NC	NC
6	NC	Common	13	NC	NC
			14	NC	NC

NOTES:

- NC = Do Not Connect.
- Duplicate pin functions are internally connected.
- All dimensions are in inches (millimeters).
- GRID: 0.100 inches (2.54 millimeters)
- MATERIAL: Lead material is phosphor bronze; lead finish is 100-300 microinches of matte tin over a nickel barrier layer of 5-40 microinches.

ABSOLUTE MAXIMUM RATINGS

Internal Power Dissipation 450mW
 Short Circuit Duration..... Momentary

ORDERING INFORMATION

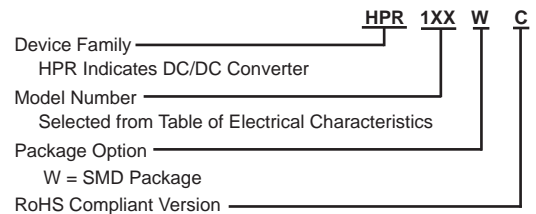

Murata Power Solutions, Inc.
 11 Cabot Boulevard, Mansfield, MA 02048-1151 U.S.A.
 ISO 9001 and 14001 REGISTERED



This product is subject to the following **operating requirements** and the **Life and Safety Critical Application Sales Policy:**
 Refer to: <http://www.murata-ps.com/requirements/>

Murata Power Solutions, Inc. makes no representation that the use of its products in the circuits described herein, or the use of other technical information contained herein, will not infringe upon existing or future patent rights. The descriptions contained herein do not imply the granting of licenses to make, use, or sell equipment constructed in accordance therewith. Specifications are subject to change without notice. © 2014 Murata Power Solutions, Inc.