

Rectifier Diode SXXHNS/HRS250

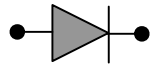

| Symbol | Characteristics | Conditions | $T_J(^{\circ}\text{C})$ | Value | Unit |
|--|---|--|-------------------------|-----------|--------------------|
| BLOCKING PARAMETERS | | | | | |
| V_{RRM} | Repetitive peak reverse voltage | | 180 | 200-1500 | V |
| I_{RRM} | Repetitive peak reverse current | $V = V_{RRM}$ | 180 | 50 | mA |
| CONDUCTING PARAMETERS | | | | | |
| $I_{F(AV)}$ | Average on-state current | 180 sine, 50Hz, $T_C = 130^{\circ}\text{C}$ | | 250 | A |
| I_{RMS} | RMS on-state current | | | 392 | A |
| I_{FSM} | Non repetitive peak surge on-state current | Sine wave, 10mS without reverse voltage | 180 | 5000 | A |
| I^2t | Permissible surge energy | | | 125.00 | kJA ² S |
| V_{FM} | Peak on-state voltage drop | On-state current = 785A | 180 | 1.30 | V |
| V_0 | Typical forward conduction Threshold voltage | | 180 | 0.75 | V |
| r_0 | Typical forward slope resistance | | 180 | 0.56 | m Ω |
| THERMAL & MECHANICAL PARAMETERS | | | | | |
| $R_{TH(J-C)}$ | Thermal impedance, 180 ^o conduction, Sine | Junction to case | | 0.18 | ^o C/W |
| $R_{TH(C-HK)}$ | Thermal impedance | Case to heatsink | | 0.05 | ^o C/W |
| T_J | Maximum Permissible junction temperature | | | 180 | ^o C |
| T_{STG} | Storage temperature range | | | -40 – 180 | ^o C |
| F | Mounting Torque | | | 16 | NM |
| W | Weight | | | 270 | gms |



HIND RECTIFIERS LTD

Rectifier Diode SXXHNS/HRS250

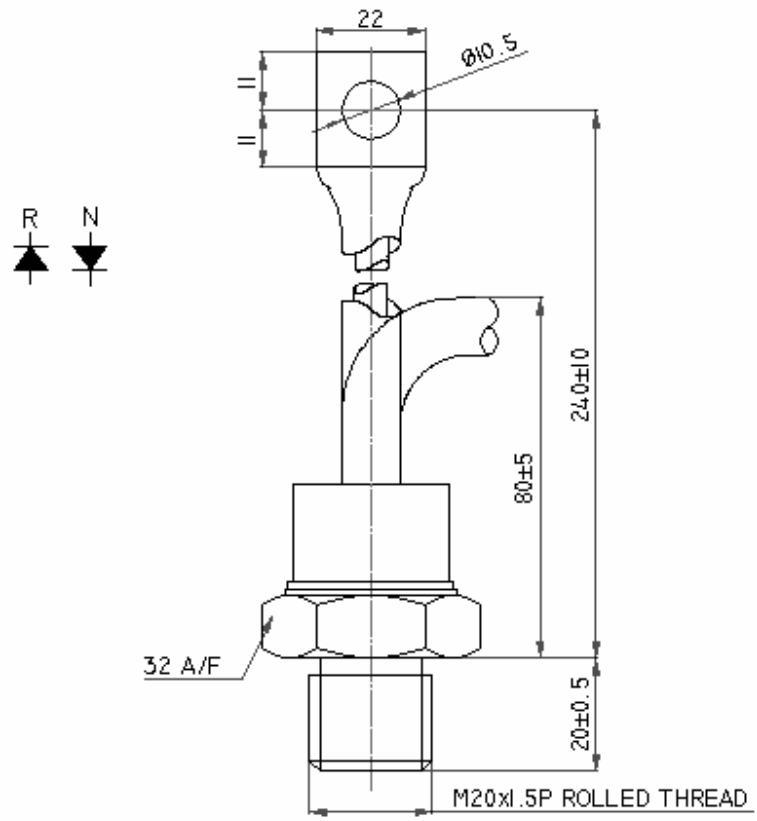
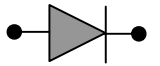

All dimensions in mm

On State Power Loss

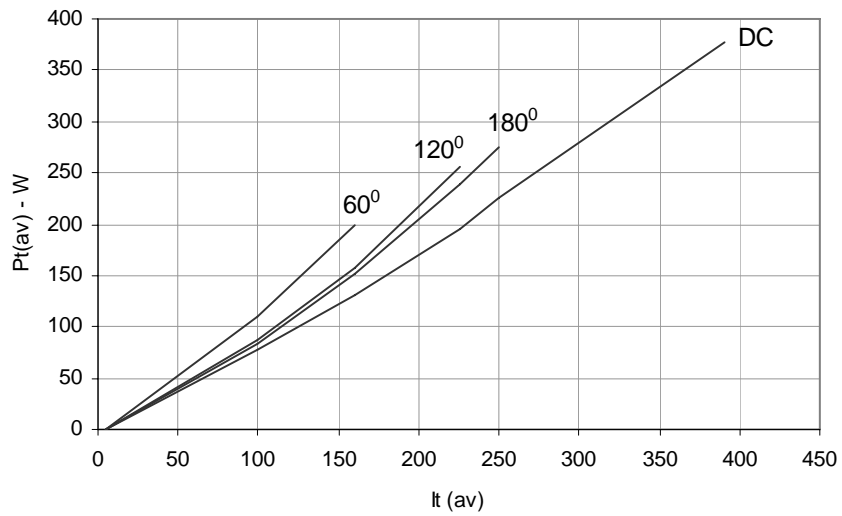

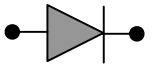

Maximum Permissible Case Temp

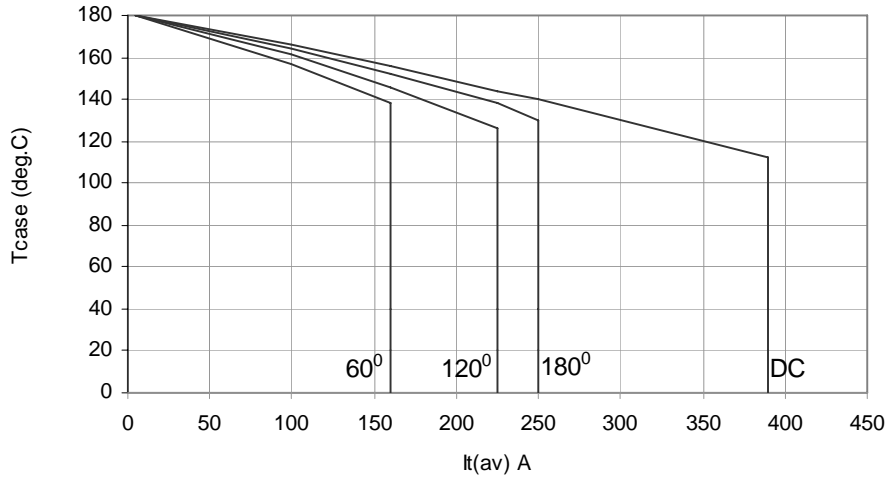

Max non repetitive Surge Current

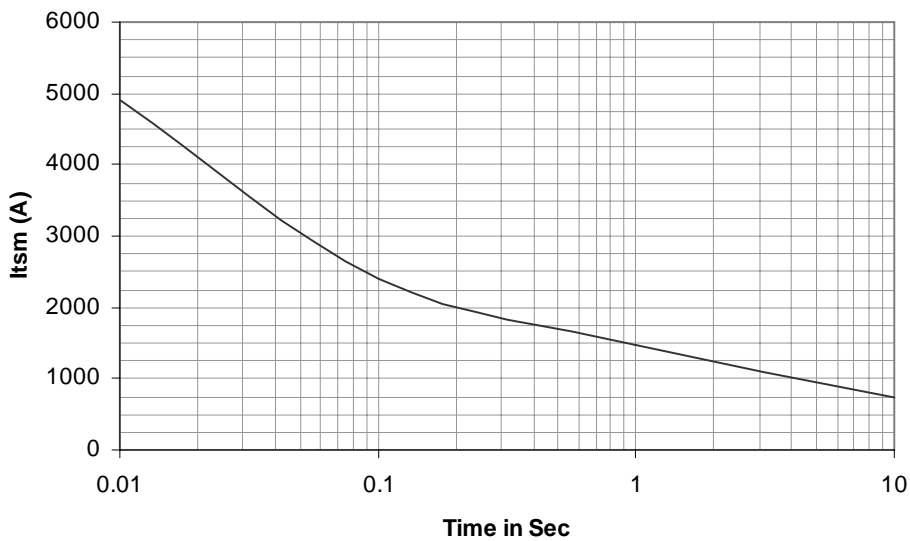

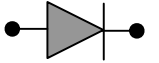

Transient Thermal Impedance Junction to Case

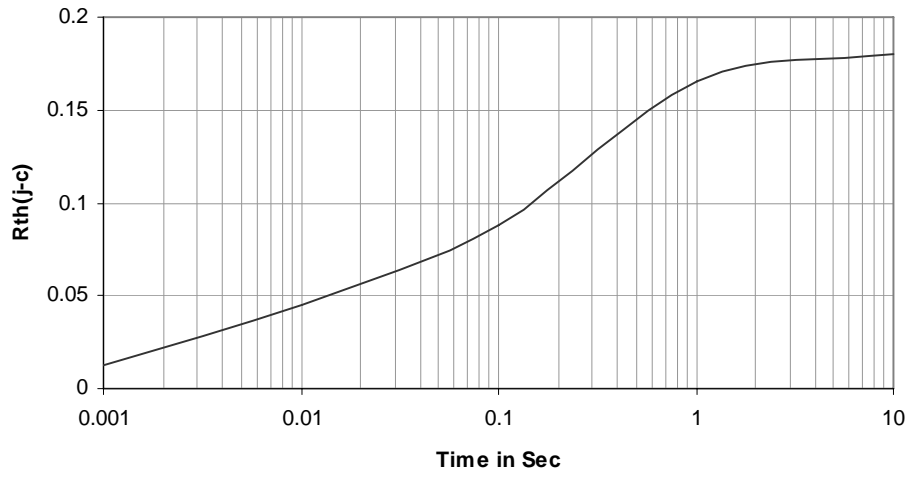

On State Characteristics

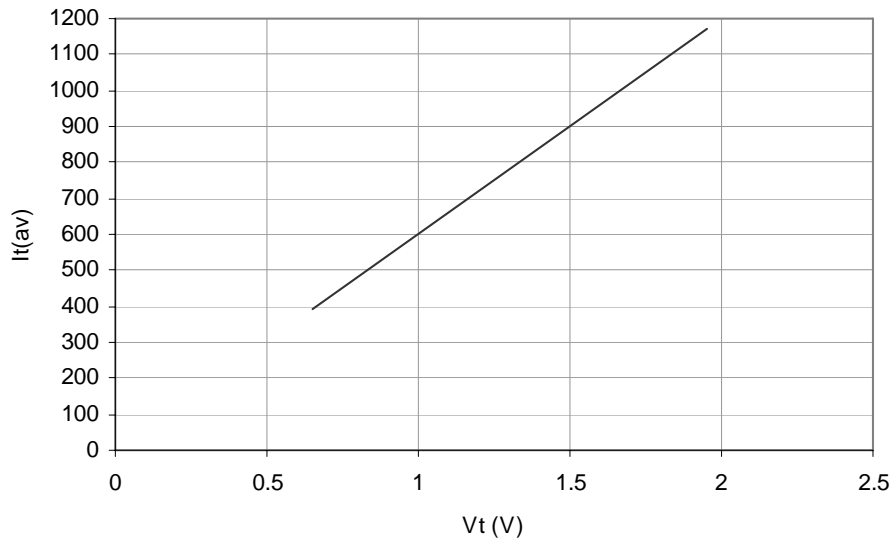

Rectifier Diode SXXHNS/HRS250

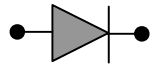

Ordering Information: -

| S | XX | HNS / HRS | 250 |
|--------------------------------|---|---|--------------------|
| Hirect make Rectifier Diode | $V_{RRM} = XX * 100$ e.g.12 * 100 =1200V | HNS - Normal Polarity HRS - Reverse Polarity | $I_{F(AV)} = 250A$ |

Hind Rectifiers Ltd reserves the right to change the specifications without notice.

This datasheet specifies technical information for semiconductor devices but promises no characteristics. No warranty or guarantee expressed or implied is made regarding delivery, performance or suitability.

Hind Rectifiers Ltd

Lake Road

Bhandup (West)

Mumbai – 400 078

Tel: - +91 22 2596 8027/28/29/31

Fax: - +91 22 2596 4114

E-mail: - marketing@hirect.com

Website: - www.hirect.com

June-2008



HIND RECTIFIERS LTD

5 of 5