

HSMS-8101, 8202, 8207, 8209

Surface Mount Microwave Schottky Mixer Diodes



Data Sheet

Description/Applications

These low cost microwave Schottky diodes are specifically designed for use at X/Ku-bands and are ideal for DBS and VSAT downconverter applications. They are available in SOT-23 and SOT-143 standard package configurations.

Note that Avago's manufacturing techniques assure that dice found in pairs and quads are taken from adjacent sites on the wafer, assuring the highest degree of match.

Plastic SOT-23 Package

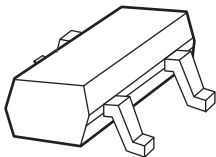

Plastic SOT-143 Package

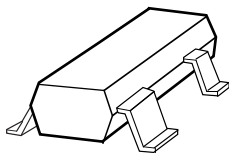

Absolute Maximum Ratings^[1], T_A = +25° C

Symbol	Parameter	Unit	Min.	Max.
P _T	Total Device Dissipation ^[2]	mW	-	75
P _{IV}	Peak Inverse Voltage	V	-	4
T _J	Junction Temperature	°C	-	+150
T _{STG} , T _{OP}	Storage and Operating Temperature	°C	-65	+150

Notes:

- Operation in excess of any one of these conditions may result in permanent damage to the device.
- Measured in an infinite heat sink at T_{CASE} = 25° C. Derate linearly to zero at 150° C per diode.

Features

- Optimized for use at 10-14 GHz
- Low Capacitance
- Low Conversion Loss
- Low RD
- Low Cost Surface Mount Plastic Package
- Lead-free Option Available

Package Lead Code Identification (Top View)

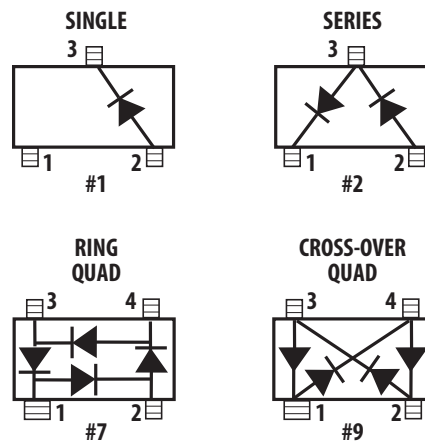

Attention: Observe precautions for handling electrostatic sensitive devices.

ESD Machine Model (Class A)
 ESD Human Body Model (Class 0)
 Refer to Avago Application Note A004R:
 Electrostatic Discharge, Damage and Control.

DC Electrical Specifications, $T_A = 25^\circ\text{C}$

Symbol	Parameters and Test Conditions	Units	HSMS-8101		HSMS-8202		HSMS-8207		HSMS-8209	
			Min.	Max.	Min.	Max.	Min.	Max.	Min.	Max.
V_{BR}	Breakdown Voltage $I_R = 10\ \mu\text{A}$	V	4		4		4		4	
C_T	Total Capacitance $V_R = 0\ \text{V}, f = 1\ \text{MHz}$	pF		0.26		0.26		0.26		0.26
DC_T	Capacitance Difference $V_R = 0\ \text{V}, f = 1\ \text{MHz}$	pF		–		0.04		0.04		0.04
R_D	Dynamic Resistance $I_F = 5\ \text{mA}$	Ω		14		14		14		14
DR_D	Dynamic Resistance Difference $I_F = 5\ \text{mA}$	Ω		–		2		2		2
V_F	Forward Voltage $I_F = 1\ \text{mA}$	mV	250	350	250	350	250	350	250	350
DV_F	Forward Voltage Difference $I_F = 1\ \text{mA}$	mV		–		20		20		20
	Lead Code		1		2		7		9	
	Package Marking Code where x is date code		R1x		2Rx		R7x		R9x	

RF Electrical Parameters, $T_A = 25^\circ\text{C}$

Symbol	Parameter	Units	Typical
L_c	Conversion Loss at 12 GHz	dB	6.3
Z_{IF}	IF Impedance	Ω	150
SWR	SWR at 12 GHz		1.2

Note:

DC Load Resistance = $0\ \Omega$; LO Power = 1 mW.

SPICE Parameters

$I_S = 4.6\ \text{E-}8$	$E_G = 0.69$	$TT = 0$
$R_S = 6$	$C_{JO} = 0.18\ \text{E-}12$	
$N = 1.09$	$P_B (V_J) = 0.5$	
$B_V = 7.3$	$M = 0.5$	
$I_{BV} = 10\ \text{E-}5$	$FC = 0.5$	

Linear Equivalent Circuit

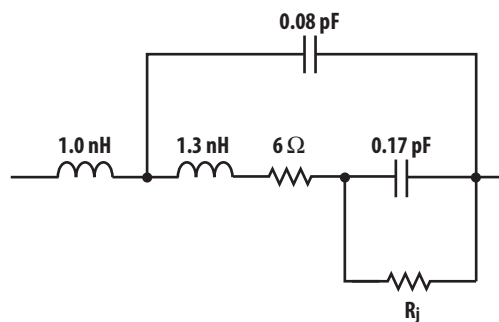

Self Bias

	1 mA	2.5 mA
R_j	256	142

Typical Performance, $T_C = 25^\circ C$

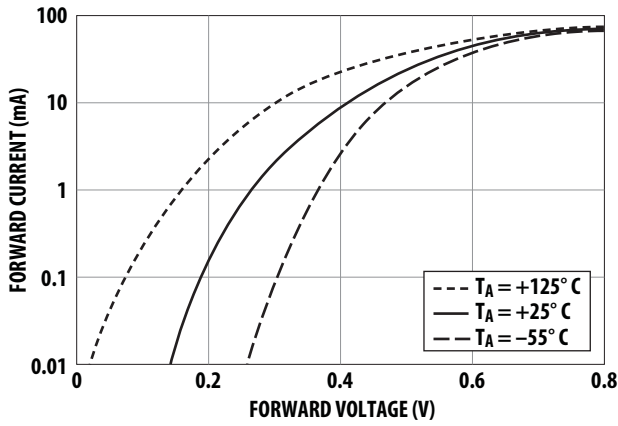

Figure 1. Typical Forward Current vs. Forward Voltage at Three Temperatures.

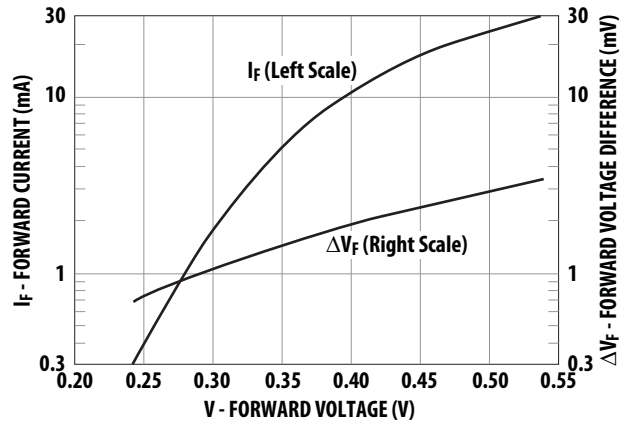

Figure 2. Typical VF Match, HSMS-820X Pairs and Quads.

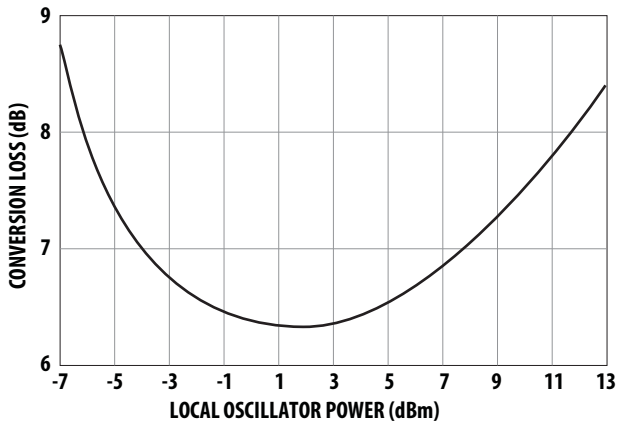
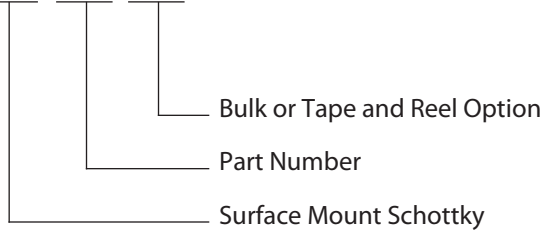

Figure 3. Typical Conversion Loss vs. Local Oscillator Power.

Ordering Information

Specify part number followed by option. For example:

HSMS - 8101 - XXX



Profile Option Descriptions

- BLK = Bulk
- TR1 = 3K pc. Tape and Reel, Device Orientation Figures 4, 5
- TR2 = 10K pc. Tape and Reel, Device Orientation Figures 4, 5

Tape and Reeling conforms to Electronic Industries RS-481, "Taping of Surface Mounted Components for Automated Placement."

For lead-free option, the part number will have the character "G" at the end, eg. - TR2G for a 10 K pc lead-free reel.

Device Orientation

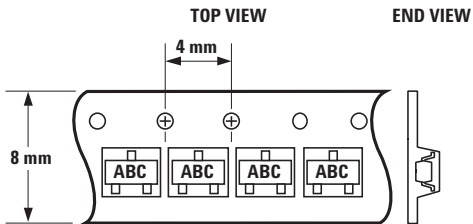
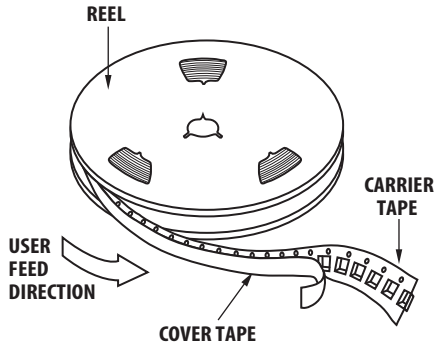

Note: "AB" represents package marking code.
"C" represents date code.

Figure 4. Option -TR1/-TR2 for SOT-23 Packages.

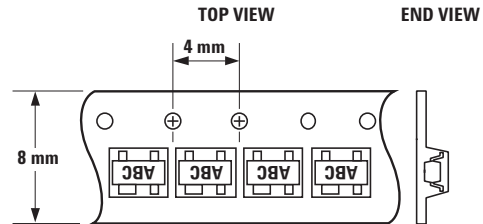

Note: "AB" represents package marking code.
"C" represents date code.

Figure 5. Option -TR1/-TR2 for SOT-143 Packages.

Package Characteristics

Lead Material	Alloy 42
Lead Finish	Tin-Lead 85-15% (Non lead-free option) or Tin 100% (Lead-free option)
Maximum Soldering Temperature	260° C for 5 seconds
Minimum Lead Strength.....	2 pounds pull
Typical Package Inductance	2 nH
Typical Package Capacitance	0.08 pF (opposite leads)

Package Dimensions Outline 23 (SOT-23)

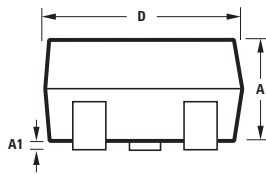
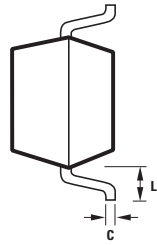
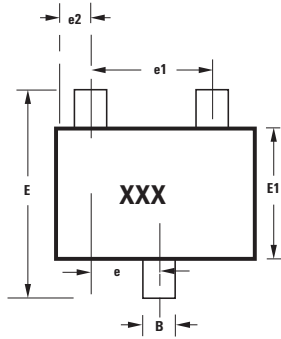

SYMBOL	DIMENSIONS (mm)	
	MIN.	MAX.
A	0.79	1.20
A1	0.000	0.100
B	0.37	0.54
C	0.086	0.152
D	2.73	3.13
E1	1.15	1.50
e	0.89	1.02
e1	1.78	2.04
e2	0.45	0.60
E	2.10	2.70
L	0.45	0.69

Notes:
XXX-package marking
Drawings are not to scale

Recommended PCB Pad Layout for Avago's SOT-23 Products

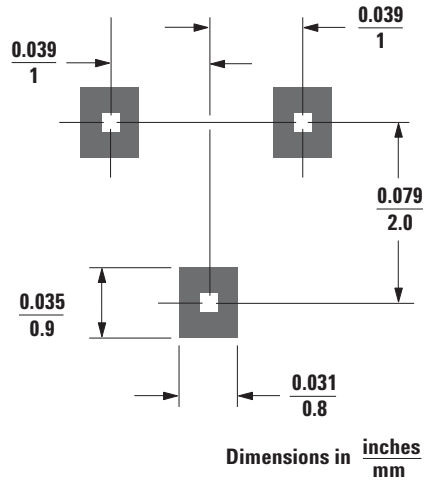

Outline 143 (SOT-143)

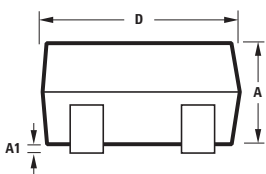
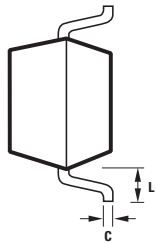
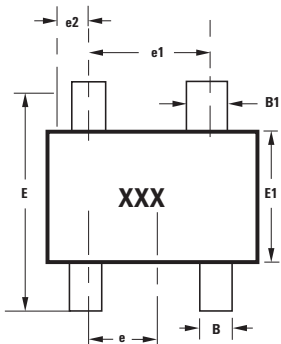

SYMBOL	DIMENSIONS (mm)	
	MIN.	MAX.
A	0.79	1.097
A1	0.013	0.10
B	0.36	0.54
B1	0.76	0.92
C	0.086	0.152
D	2.80	3.06
E1	1.20	1.40
e	0.89	1.02
e1	1.78	2.04
e2	0.45	0.60
E	2.10	2.65
L	0.45	0.69

Notes:
XXX-package marking
Drawings are not to scale

Recommended PCB Pad Layout for Avago's SOT-143 Products

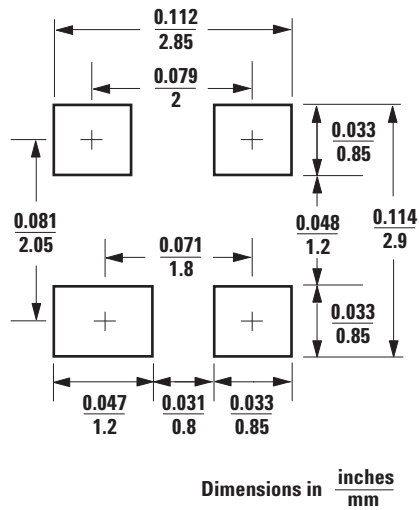

Tape Dimensions and Product Orientation For Outline SOT-23

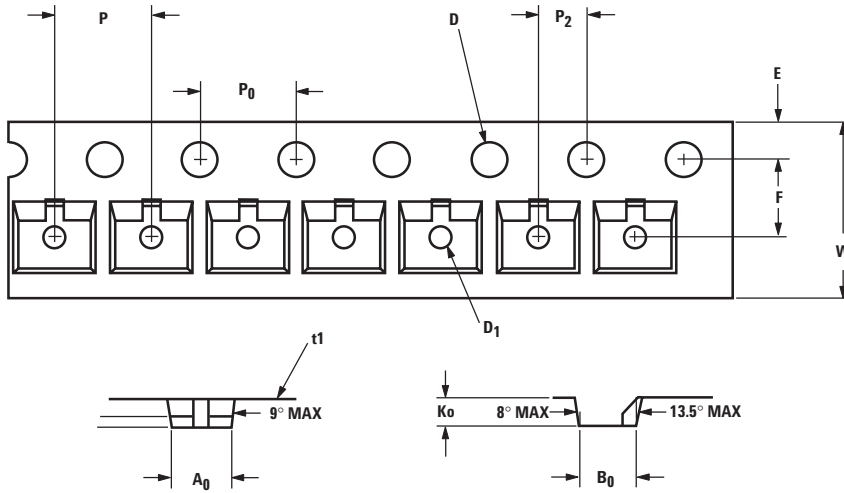

DESCRIPTION		SYMBOL	SIZE (mm)	SIZE (INCHES)
CAVITY	LENGTH	A_0	3.15 ± 0.10	0.124 ± 0.004
	WIDTH	B_0	2.77 ± 0.10	0.109 ± 0.004
	DEPTH	K_0	1.22 ± 0.10	0.048 ± 0.004
	PITCH	P	4.00 ± 0.10	0.157 ± 0.004
	BOTTOM HOLE DIAMETER	D_1	$1.00 + 0.05$	0.039 ± 0.002
PERFORATION	DIAMETER	D	$1.50 + 0.10$	$0.059 + 0.004$
	PITCH	P_0	4.00 ± 0.10	0.157 ± 0.004
	POSITION	E	1.75 ± 0.10	0.069 ± 0.004
CARRIER TAPE	WIDTH	W	$8.00 + 0.30 - 0.10$	$0.315 + 0.012 - 0.004$
	THICKNESS	t_1	0.229 ± 0.013	0.009 ± 0.0005
DISTANCE BETWEEN CENTERLINE	CAVITY TO PERFORATION (WIDTH DIRECTION)	F	3.50 ± 0.05	0.138 ± 0.002
	CAVITY TO PERFORATION (LENGTH DIRECTION)	P_2	2.00 ± 0.05	0.079 ± 0.002

Tape Dimensions and Product Orientation For Outline SOT-143

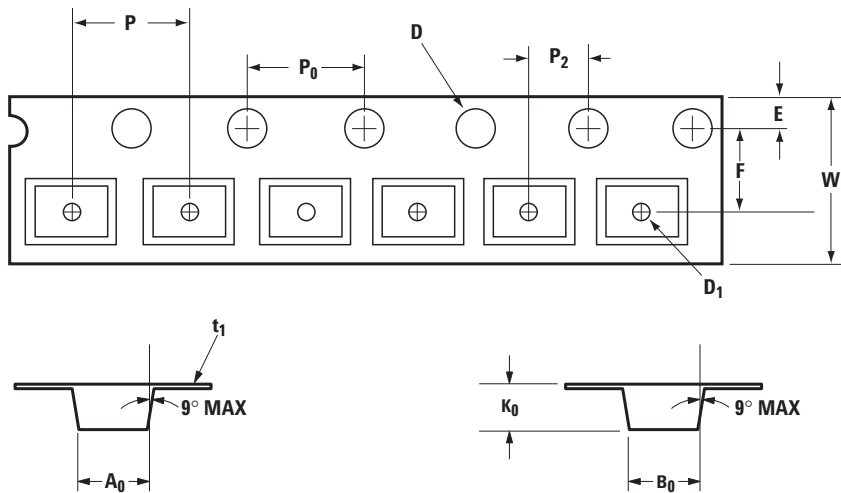

DESCRIPTION		SYMBOL	SIZE (mm)	SIZE (INCHES)
CAVITY	LENGTH	A_0	3.19 ± 0.10	0.126 ± 0.004
	WIDTH	B_0	2.80 ± 0.10	0.110 ± 0.004
	DEPTH	K_0	1.31 ± 0.10	0.052 ± 0.004
	PITCH	P	4.00 ± 0.10	0.157 ± 0.004
	BOTTOM HOLE DIAMETER	D_1	1.00 ± 0.25	0.039 ± 0.010
PERFORATION	DIAMETER	D	1.50 ± 0.10	0.059 ± 0.004
	PITCH	P_0	4.00 ± 0.10	0.157 ± 0.004
	POSITION	E	1.75 ± 0.10	0.069 ± 0.004
CARRIER TAPE	WIDTH	W	$8.00 \pm 0.30 - 0.10$	$0.315 \pm 0.012 - 0.004$
	THICKNESS	t_1	0.254 ± 0.013	0.0100 ± 0.0005
DISTANCE	CAVITY TO PERFORATION (WIDTH DIRECTION)	F	3.50 ± 0.05	0.138 ± 0.002
	CAVITY TO PERFORATION (LENGTH DIRECTION)	P_2	2.00 ± 0.05	0.079 ± 0.002

For product information and a complete list of distributors, please go to our web site: www.avagotech.com

Avago, Avago Technologies, and the A logo are trademarks of Avago Technologies in the United States and other countries. Data subject to change. Copyright © 2005-2012 Avago Technologies. All rights reserved. Obsoletes 5989-4024EN AV02-3637EN - June 19, 2012

Avago
TECHNOLOGIES