

60 V/0.7 Ohm, General Purpose, 1 Form A, Solid State Relay

Technical Data

Features

- Compact Solid-State Bidirectional Switch
- Normally-Off Single-Pole Relay Function (1 Form A)
- 60 V Output Withstand Voltage in Both Polarities at 25°C
- 0.75/1.5 Amp Current Ratings (See Schematic for Connections A & B)
- Low Input Current; CMOS Compatibility
- Very Low On-resistance: 0.4 Ω Typical at 25°C
- ac/dc Signal and Power Switching
- Input-to-Output Momentary Withstand Insulation Voltage: 2500 Vac, 1 Minute
- 16-kV ESD Immunity: MIL-STD-883, Method 3015
- IEEE Surge Withstand Capability (IEEE STD 472-1974)
- CSA Approved
- UL 508 Approved

Applications

- Programmable Logic Controllers

- Telecommunication Switching Equipment
- Reed Relay Replacement
- 28 Vdc, 24 Vac, 48 Vdc Load Driver
- Industrial Relay Coil Driver

Description

The HSSR-8060 consists of a high-voltage circuit, optically coupled with a light emitting diode (LED). This device is a solid-state replacement for single-pole, normally-open (1 Form A) electromechanical relays used for general purpose switching of signals and low-power loads. The relay turns on (contact closes) with a minimum input current, I_F , of 5 mA through the input LED. The relay turns off (contact opens) with an input voltage, V_F , of 0.8 V or less. The detector contains a high speed photosensitive FET driver circuit and two high voltage MOSFETs.

This relay's logic level input control and very low typical output on-resistance of 0.4 Ω makes it suitable for both ac and dc loads. Connection A, as shown in the schematic, allows the relay to

HSSR-8060

switch either ac or dc loads. Connection B, with the polarity and pin configuration as indicated in the schematic, allows the relay to switch dc loads only. The advantage of Connection B is that the on-resistance is significantly reduced, and the output current capability increases by a factor of two.

The electrical and switching characteristics of the HSSR-8060 are specified from -40°C to +85°C.

Functional Diagram

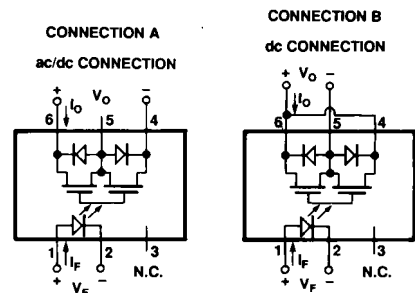

TRUTH TABLE
(POSITIVE LOGIC)

LED	OUTPUT
ON	L
OFF	H

CAUTION: It is advised that normal static precautions be taken in handling and assembly of this component to prevent damage and/or degradation which may be induced by ESD.

Selection Guide

6-Pin DIP (300 Mil)	4-Pin DIP (300 Mil)	Maximum Speed t(ON) msec 25°C	Maximum ON Resistance R(ON) Ω 25°C	Maximum Output Voltage VO(off) V 25°C	Maximum Output Current Io(ON) mA 25°C	Minimum Input Current mA	Hermetic 8-Pin
Single Channel Package	Dual Channel Package						Single Channel Packages
HSSR-8400 ^[1]		0.95	10	400	150	5	
HSSR-8060		1.4	0.7	60	750	5	
	HSSR-8200 ^[1]	1.5	200	200	40	1	
		6	1	90	800	5	HSSR-7110 ^[1]

Note:

1. Technical data are on separate HP publication.

Ordering Information

Specify part number followed by Option Number (if desired).

HSSR-8060#XXX

- 300 = Gull Wing Surface Mount Lead Option
- 500 = Tape/Reel Package Option (1 k min.)

Option data sheets available. Contact your Hewlett-Packard sales representative or authorized distributor for information.

Schematic

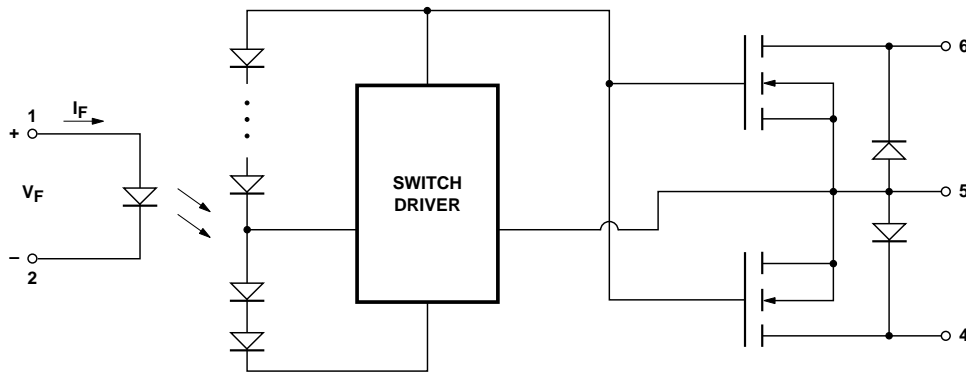

Outline Drawing

6-pin DIP Package (HSSR-8060)

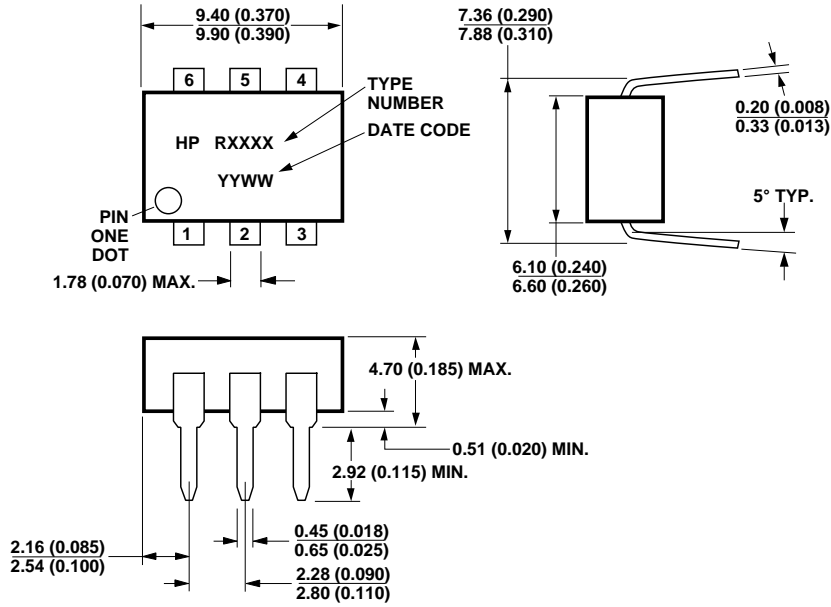

DIMENSIONS IN MILLIMETERS AND (INCHES).

6-Pin Device Outline Drawing Option #300 (Gull Wing Surface Mount)

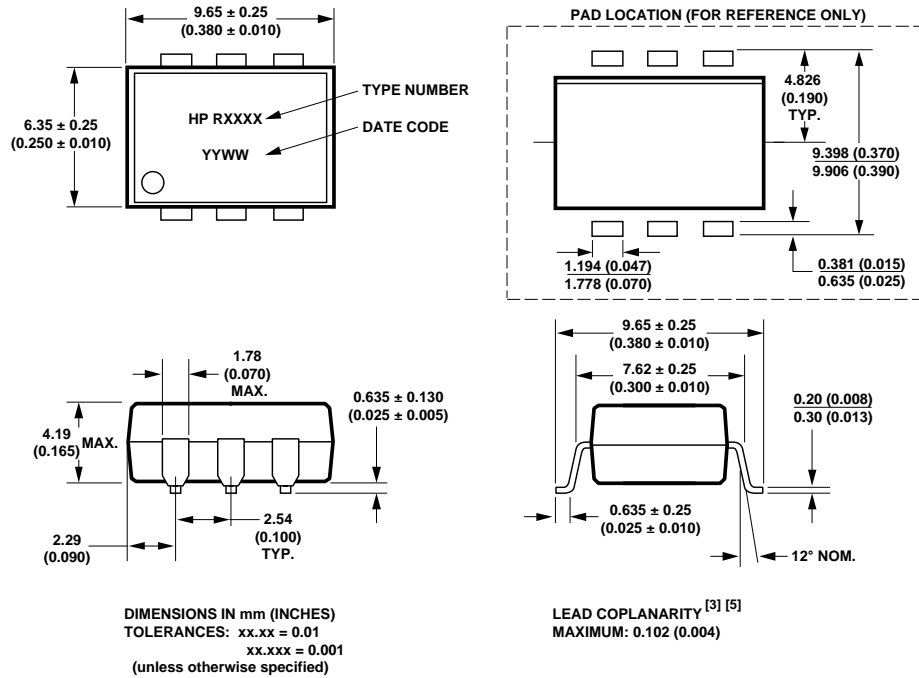

Thermal Profile (Option #300)

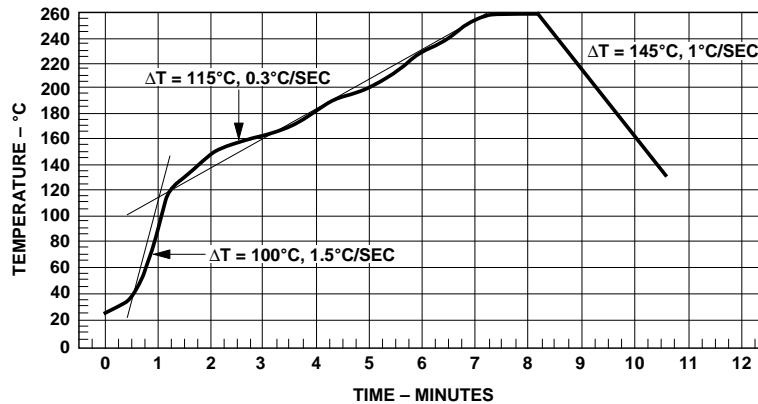

Figure 1. Maximum Solder Reflow Thermal Profile.
 (Note: Use of non-chlorine activated fluxes is recommended.)

Regulatory Information

The HSSR-8060 has been approved by the following organizations:

UL

Recognized under UL 508, Component Recognition Program, Industrial Control Switches, File E142465.

CSA

Approved under CAN/CSA-C22.2 No. 14-95, Industrial Control Equipment, File LR 87683.

Insulation and Safety Related Specifications

Parameter	Symbol	Value	Units	Conditions
Min. External Air Gap (External Clearance)	L(IO1)	7.0	mm	Measured from input terminals to output terminals, shortest distance through air
Min. External Tracking Path (External Creepage)	L(IO2)	8.5	mm	Measured from input terminals to output terminals, shortest distance path along body
Min. Internal Plastic Gap (Internal Clearance)		0.5	mm	Through insulation distance, conductor to conductor, usually the direct distance between the photoemitter and photodetector inside the optocoupler cavity
Tracking Resistance (Comparative Tracking Index)	CTI	200	V	DIN IEC 112/VDE 0303 PART 1
Isolation Group		IIIa		Material Group (DIN VDE 0110, 1/89, Table 1)

Option 300 – surface mount classification is Class A in accordance with CECC 00802.

Absolute Maximum Ratings

Storage Temperature	-55°C to +125°C
Operating Temperature - T_A	-40°C to +85°C
Case Temperature - T_C	+105°C ^[1]
Average Input Current - I_F	20 mA
Repetitive Peak Input Current - I_F	40 mA
	(Pulse Width \leq 1 ms; duty cycle \leq 50%)
Transient Peak Input Current - I_F	100 mA
	(Pulse Width \leq 200 μ s; duty cycle \leq 1%)
Reverse Input Voltage - V_R	3 V
Input Power Dissipation	40 mW
Output Voltage ($T_A = 25^\circ\text{C}$)	
Connection A - V_O	-60 to +60 V
Connection B - V_O	0 to +60 V
Average Output Current - Figure 3 ($T_A = 25^\circ\text{C}$, $T_C \leq 70^\circ\text{C}$)	
Connection A - I_O	0.75 A
Connection B - I_O	1.50 A
Single Shot Peak Output Current	
(100 ms pulse width, $T_A = 25^\circ\text{C}$, $I_F = 10$ mA)	
Connection A - I_O	3.75 A
Connection B - I_O	7.0 A
Output Power Dissipation	750 mW ^[2]
Lead Solder Temperature	260°C for 10 S (1.6 mm below seating plane)
Infrared and Vapor Phase Reflow Temperature	
(Option #300)	See Fig. 1, Thermal Profile

Thermal Resistance

Typical Output MOSFET Junction to Case - $\theta_{JC} = 55^\circ\text{C/W}$

Demonstrated ESD Performance

Human Body Model: MIL-STD-883 Method 3015.7 - 16 kV
Machine Model: EIAJ 1988.3.28 Version 2), Test Method 20, Condition C - 1200 V

Surge Withstand Capability

IEEE STD 472-1974

Recommended Operating Conditions

Parameter	Symbol	Min.	Max.	Units
Input Current (ON)	$I_{F(ON)}$	5	20	mA
Input Voltage (OFF)	$V_{F(OFF)}$	0	0.8	Volt
Operating Temperature	T_A	-40	+85	°C
Output Voltage Connection A	$V_{O(OFF)}$	-55	55	Volt
Connection B		0	55	
Output Current Connection A	$I_{O(ON)}$	-0.75	0.75	A
Connection B		-1.5	1.5	

DC Electrical Specifications

For $-40^{\circ}\text{C} \leq T_A \leq +85^{\circ}\text{C}$ unless otherwise specified. All Typicals at $T_A = 25^{\circ}\text{C}$.

Parameter	Conne- ction	Sym.	Min.	Typ.	Max.	Units	Test Conditions	Fig.	Notes
Output Withstand Voltage	A	$ V_{O(OFF)} $	60			V	$V_F = 0.8\text{ V}, I_O = 250\ \mu\text{A}, T_A = 25^{\circ}\text{C}$	5	
			55				$V_F = 0.8\text{ V}, I_O = 250\ \mu\text{A}$		
Output On-Resistance	A	$R_{(ON)}$		0.4	0.7	Ω	$I_F = 10\text{ mA}, I_O = 750\text{ mA}$ (pulse duration $\leq 30\text{ ms}$), $T_A = 25^{\circ}\text{C}$	6,7	3
	B			0.1	0.2				
	A				1.6		$I_F = 10\text{ mA}, I_O = 750\text{ mA}$ (pulse duration $\leq 30\text{ ms}$)		
	B				0.4				
Output Leakage Current	A	$I_{O(OFF)}$		10^{-4}	1.0	μA	$V_F = 0.8\text{ V}, V_O = 60\text{ V}, T_A = 25^{\circ}\text{C}$	13	
Output Off-Capacitance	A	$C_{(OFF)}$		135		pF	$V_F = 0.8\text{ V}, V_O = 25\text{ V}, f = 1\text{ MHz}$	14	
Output Off-set Voltage	A	$ V_{OS} $		1		μV	$I_F = 5\text{ mA}, I_O = 0\text{ mA}$	18	4
Input Reverse Breakdown Voltage		V_R	3			V	$I_R = 100\ \mu\text{A}$		
Input Forward Voltage		V_F	1.3	1.6	1.85	V	$I_F = 10\text{ mA}, T_A = 25^{\circ}\text{C}$	15	
Input Diode Temperature Coefficient		$\Delta V_F/\Delta T_A$		-1.3		mV/°C	$I_F = 10\text{ mA}$		
Input Capacitance		C_{IN}		72		pF	$V_F = 0\text{ V}, f = 1\text{ MHz}$		

Switching Specifications

For $-40^{\circ}\text{C} \leq T_A \leq +85^{\circ}\text{C}$ with Connection A, unless otherwise specified. All Typical at $T_A = 25^{\circ}\text{C}$.

Parameter	Symbol	Min.	Typ.	Max.	Units	Test Conditions	Fig.	Notes
Turn On Time	t_{ON}		0.93	1.4	ms	$I_F = 10 \text{ mA}, V_{\text{DD}} = 60 \text{ V}, I_O = 750 \text{ mA}, T_A = 25^{\circ}\text{C}$	2, 8, 9, 10, 20, 21	7
				1.8	ms	$I_F = 10 \text{ mA}, V_{\text{DD}} = 55 \text{ V}, I_O = 750 \text{ mA}$		
Turn Off Time	t_{OFF}		0.013	0.1	ms	$I_F = 10 \text{ mA}, V_{\text{DD}} = 60 \text{ V}, I_O = 750 \text{ mA}, T_A = 25^{\circ}\text{C}$	2, 8, 11, 12, 20, 21	
				0.1	ms	$I_F = 10 \text{ mA}, V_{\text{DD}} = 55 \text{ V}, I_O = 750 \text{ mA}$		
Output Transient Rejection	$ dV_O/dt $	1000			V/ μs	$V_{(\text{peak})} = 60 \text{ V}, R_M \geq 1 \text{ M}\Omega, C_M = 1000 \text{ pF}, T_A = 25^{\circ}\text{C}$	16	
Input-Output Transient Rejection	$ dV_{\text{I-O}}/dt $	2500			V/ μs	$V_{\text{DD}} = 5 \text{ V}, V_{\text{I-O}(\text{peak})} = 1000 \text{ V}, R_L = 1 \text{ k}\Omega, C_L = 25 \text{ pF}, T_A = 25^{\circ}\text{C}$	17	

Package Characteristics

For $0^{\circ}\text{C} \leq T_A \leq 70^{\circ}\text{C}$, unless otherwise specified. All typicals at $T_A = 25^{\circ}\text{C}$.

Parameter	Symbol	Min.	Typ.	Max.	Units	Test Conditions	Fig.	Notes
Input-Output Momentary Withstand Voltage*	V_{ISO}	2500			V rms	$\text{RH} \leq 50\%, t = 1 \text{ min}, T_A = 25^{\circ}\text{C}$		5, 6
Resistance Input-Output	$R_{\text{I-O}}$		100		G Ω	$V_{\text{I-O}} = 500 \text{ Vdc}, t = 1 \text{ min}, \text{RH} = 45\%$		5
Capacitance Input-Output	$C_{\text{I-O}}$		1.0		pF	$V_{\text{I-O}} = 0 \text{ V}, f = 1 \text{ MHz}$		5

*The Input-Output Momentary Withstand Voltage is a dielectric voltage rating that should not be interpreted as an input-output continuous voltage rating. For the continuous voltage rating refer to the VDE 0884 Insulation Characteristics Table (if applicable), your equipment level safety specification, or HP Application Note 1074, "Optocoupler Input-Output Endurance Voltage."

Notes:

- The case temperature, T_C , is measured at the center of the bottom of the package.
- For derating, see Figure 4. The output power P_O derating curve is obtained when the part is handling the maximum average output current I_O as shown in Figure 3.
- During the pulsed R_{ON} measurement (I_O duration $\leq 30 \text{ ms}$), ambient (T_A) and case temperature (T_C) are equal.
- V_{OS} is a function of I_F , and is defined between pins 4 and 6, with pin 4 as the reference. V_{OS} must be measured in a stable ambient (free of temperature gradients).
- Device considered a two terminal device: pins 1, 2, and 3 shorted together and pins 4, 5, and 6 shorted together.
- This is a momentary withstand proof test. These parts are 100% tested in production at 3000 V rms, one second.
- For a faster turn-on time, the optional peaking circuit shown in Figure 2 may be implemented.

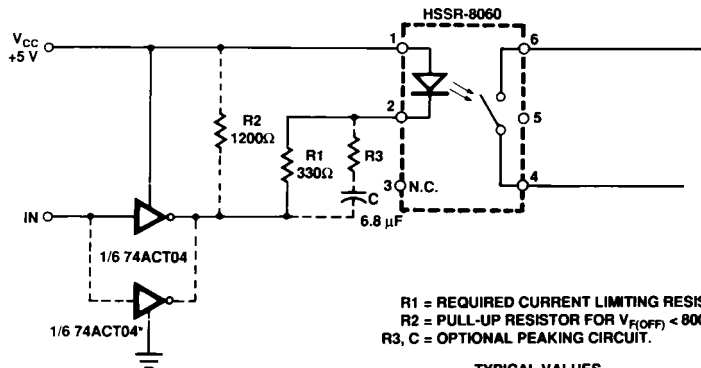

TYPICAL VALUES

R3 (Ω)	$I_{F(PK)}$ (mA)	HSSR-8060 t_{ON} (ms)
-	10 (no pk)	0.93
330	20	0.53
100	40	0.32
33	100	0.17

*USE SECOND GATE IF $I_{F(PK)} > 50 \text{ mA}$.

Figure 2. Recommended Input Circuit.

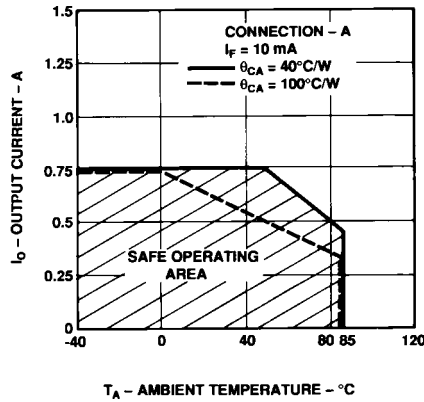

Figure 3A. Maximum Average Output Current Rating vs. Ambient Temperature.

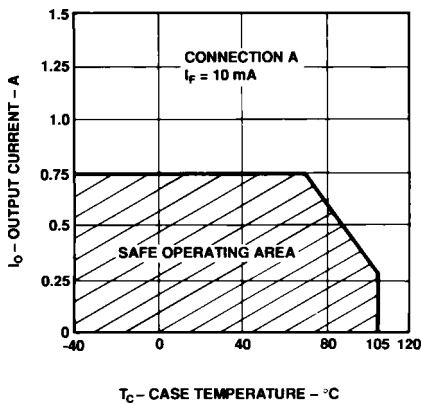

Figure 3B. Maximum Average Output Current Rating vs. Case Temperature.

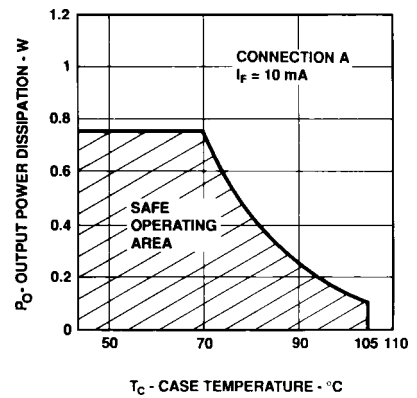

Figure 4. Output Power Derating vs. Case Temperature.

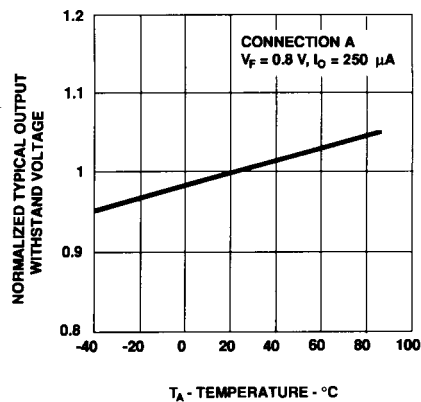

Figure 5. Normalized Typical Output Withstand Voltage vs. Temperature.

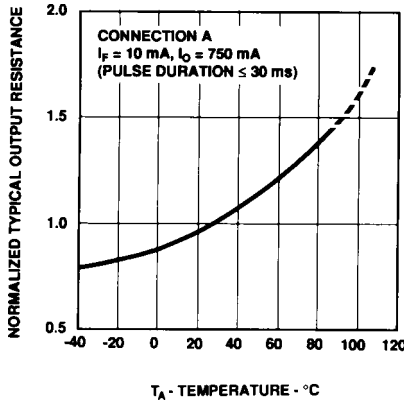

Figure 6. Normalized Typical Output Resistance vs. Temperature.

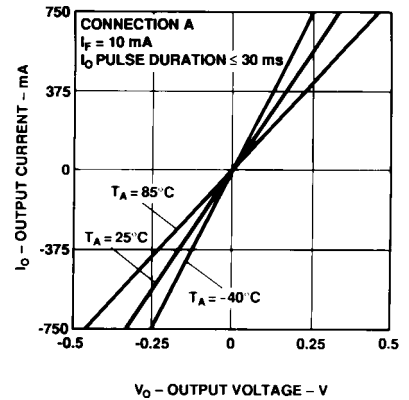

Figure 7. Typical On State Output I-V Characteristics.

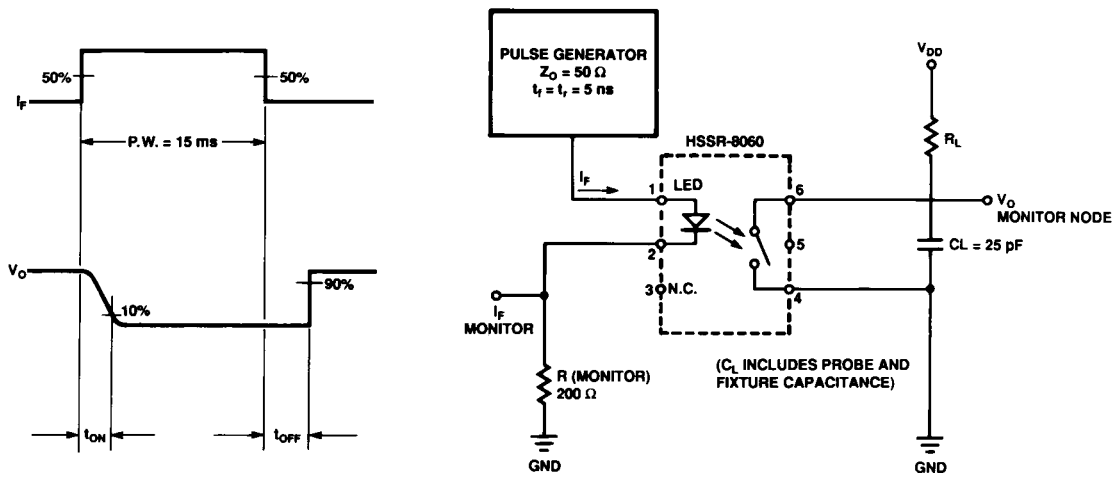

Figure 8. Switching Test Circuit for t_{ON} , t_{OFF} .

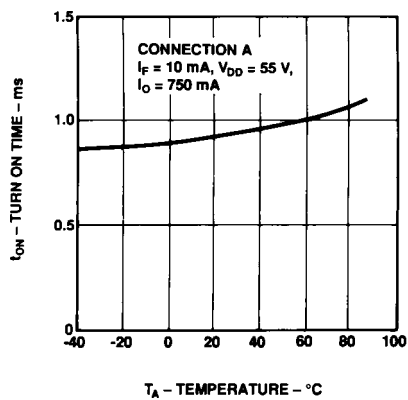

Figure 9. Typical Turn On Time vs. Temperature.

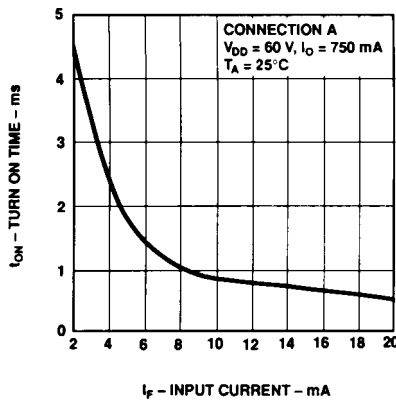

Figure 10. Typical Turn On Time vs. Input Current.

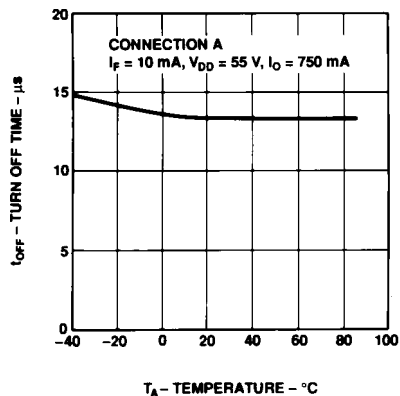

Figure 11. Typical Turn Off Time vs. Temperature.

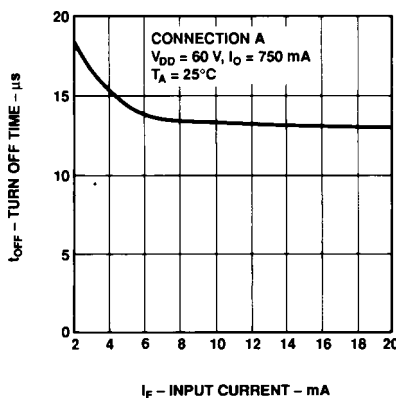

Figure 12. Typical Turn Off Time vs. Input Current.

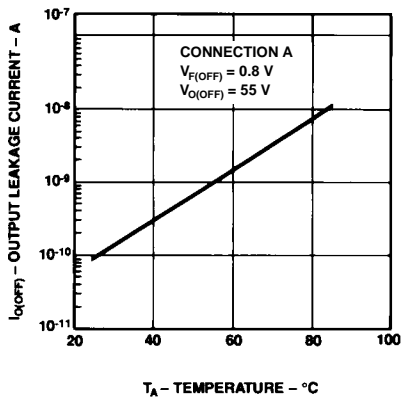

Figure 13. Typical Output Leakage vs. Temperature.

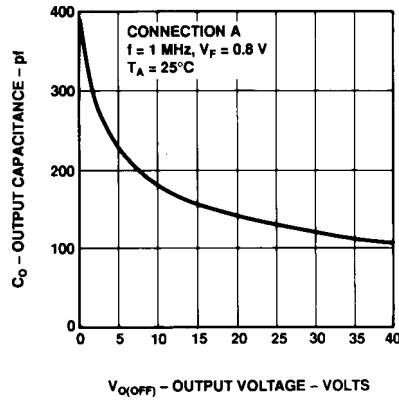

Figure 14. Typical Output Capacitance vs. Output Voltage.

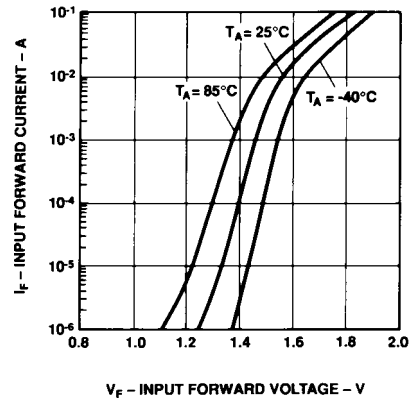

Figure 15. Typical Input Forward Current vs. Input Forward Voltage.

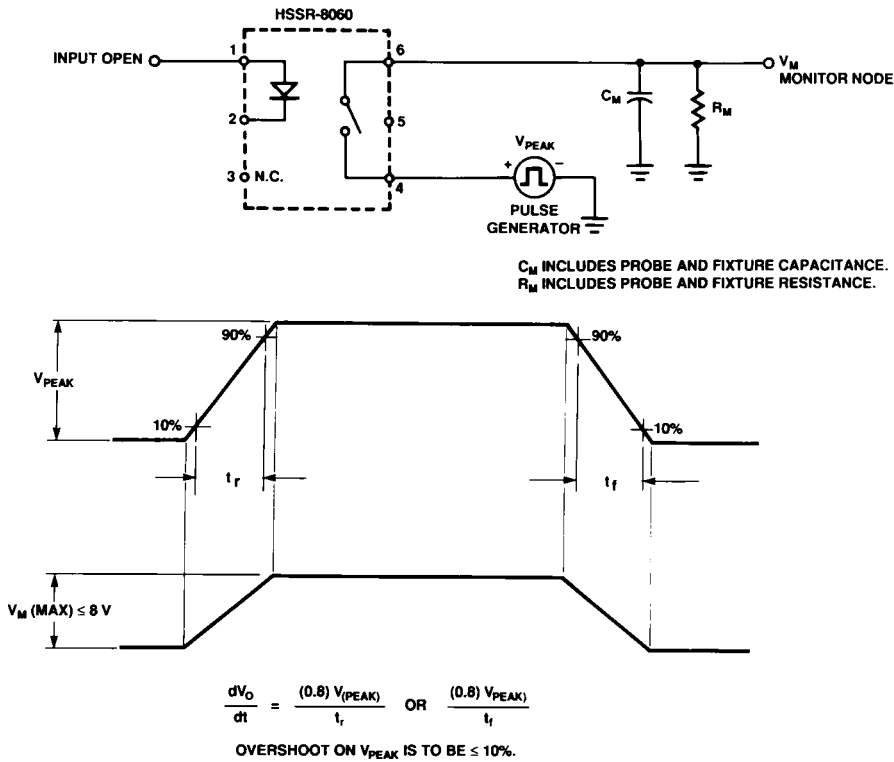

Figure 16. Output Transient Rejection Test Circuit.

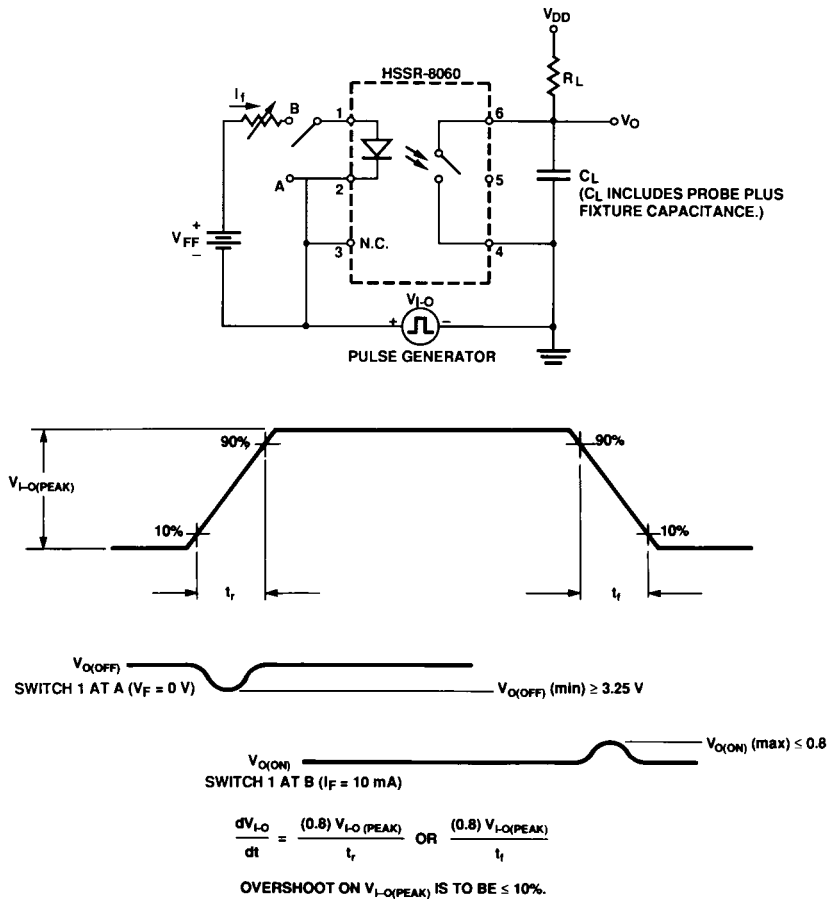

Figure 17. Input-Output Transient Rejection Test Circuit.

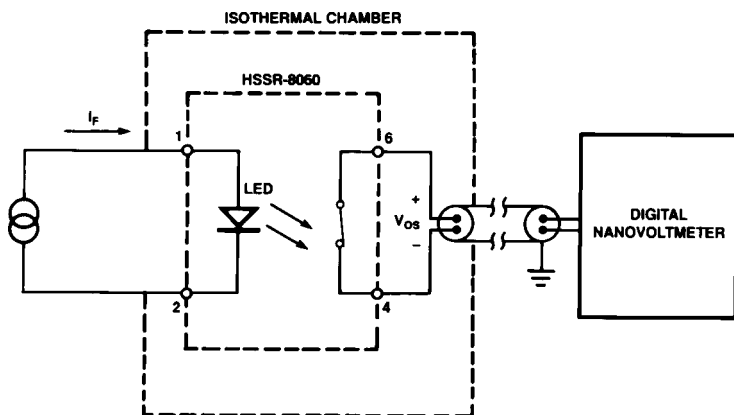
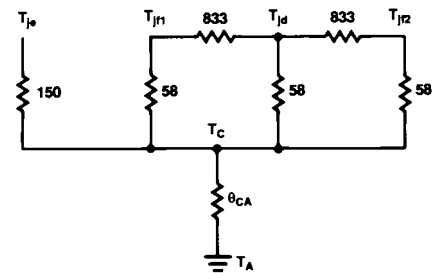

Figure 18. Voltage Offset Test Setup.



- T_{J0} = LED JUNCTION TEMPERATURE
- T_{J11} = FET 1 JUNCTION TEMPERATURE
- T_{J12} = FET 2 JUNCTION TEMPERATURE
- T_{Jd} = FET DRIVER JUNCTION TEMPERATURE
- T_C = CASE TEMPERATURE (MEASURED AT CENTER OF PACKAGE BOTTOM)
- T_A = AMBIENT TEMPERATURE (MEASURED 15 cm AWAY FROM THE PACKAGE)
- θ_{CA} = CASE-TO-AMBIENT THERMAL RESISTANCE

ALL THERMAL RESISTANCE VALUES ARE IN $^{\circ}\text{C}/\text{W}$.

Figure 19. Thermal Model.

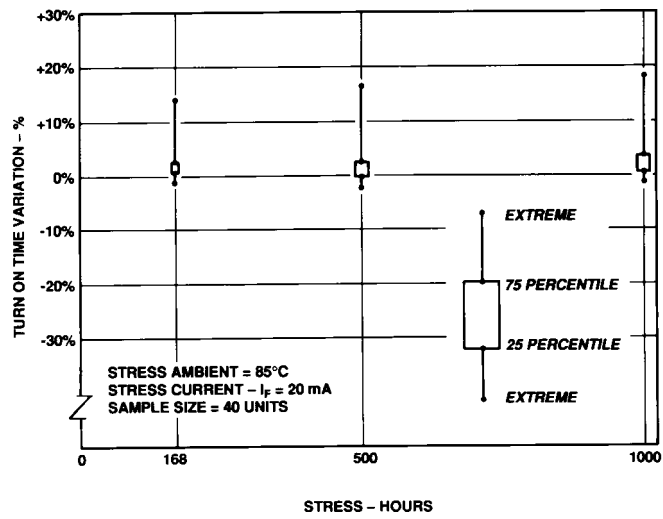

Figure 20. Turn On Time Variation with High Temperature Operating Life.

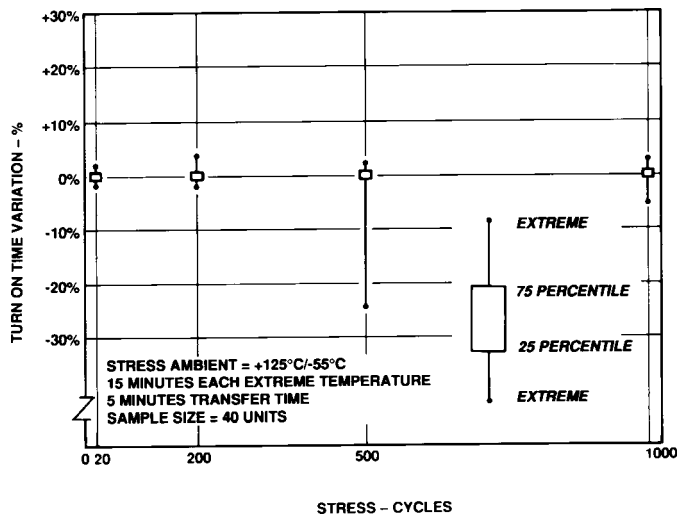

Figure 21. Turn On Time Variation with Temperature Cycling.

Applications Information

Thermal Model

The steady state thermal model for the HSSR-8400 is shown in Figure 19. The thermal resistance values given in this model can be used to calculate the temperatures at each node for a given operating condition. The thermal resistances between the LED and other internal nodes are very large in comparison with the other terms and are omitted for simplicity. The components do, however, interact indirectly through θ_{CA} , the case-to-ambient thermal resistance. All heat generated flows through θ_{CA} , which raises the case temperature T_C accordingly. The value of θ_{CA} depends on the conditions of the board design and is, therefore, determined by the designer.

The typical value for each output MOSFET junction-to-case thermal resistance is specified as 55°C/W. This is the thermal resistance from one MOSFET junction to the case when power is dissipated equally in the MOSFETs. The power dissipation in the FET Driver is negligible in comparison to the MOSFETs.

On-Resistance and Derating Curves

The output on-resistance, R_{ON} , specified in this data sheet, is the resistance measured across the output contact when a pulsed current signal ($I_O = 150$ mA) is applied to the output pins. The use of a pulsed signal (≤ 30 ms) implies that each junction temperature is equal to the ambient and case temperatures. The steady-state resistance, R_{SS} , on the other hand, is the value of the resistance measured across the output contact when a DC current signal is applied to the output pins for a duration sufficient to reach thermal equilibrium. R_{SS} includes the effects of the temperature rise of each element in the thermal model.

Derating curves are shown in Figures 3 and 4. Figure 3 specifies the maximum average output current allowable for a given ambient or case temperature. Figure 4 specifies the output power dissipation allowable for a given case temperature. Above a case temperature of 93°C, the maximum allowable output current and power dissipation are

related by the expression $R_{SS} = P_O(\max)/(I_O(\max))^2$ from which R_{SS} can be calculated. Staying within the safe area assures that the steady state junction temperatures remain less than 125°C. As an example, for a case temperature of 100°C, Figure 4 shows that the output power dissipation should be limited to less than 0.5 watts. A check with Figure 3B shows that the output current should be limited to less than 150 mA. This yields an R_{SS} of 22 Ω .

Turn On Time Variation

For applications which are sensitive to turn on time, the designer should refer to Figures 20 and 21. These figures show that although there is very little variation in t_{ON} within most of the population, a portion of the distribution will vary with use. The optional peaking circuit shown in Figure 2 can be used to reduce the total turn on time and, consequently, any associated variation.