

Ultrafast Recovery Modules HU100, 101 & 102

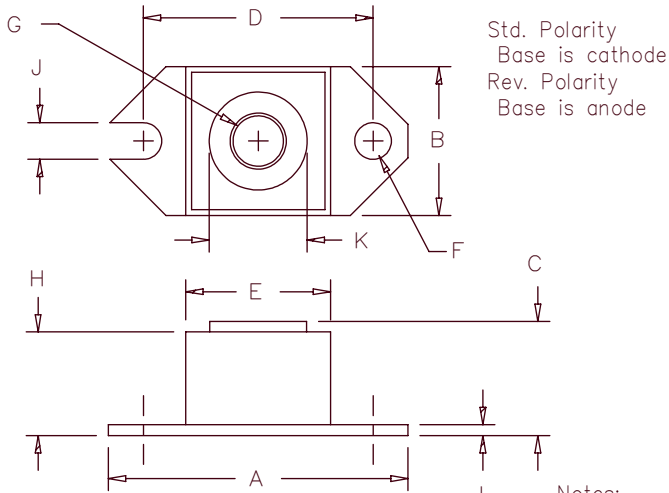

Dim.	Inches		Millimeter		Notes
	Minimum	Maximum	Minimum	Maximum	
A	1.52	1.56	38.86	39.62	
B	.725	.775	18.42	19.69	
C	.605	.625	15.37	15.88	
D	1.177	1.197	29.90	30.41	
E	.745	.755	18.92	19.18	Sq.
F	.152	.162	3.86	4.11	Dia.
G		1/4-20	UNC-2B		
H	.540	.580	13.72	14.73	
J	.152	.162	3.86	4.11	
K	.495	.505	12.57	12.83	Dia.
L	.120	.130	3.05	3.30	

Notes:
Baseplate: Nickel plated
copper

Microsemi Catalog Number	Working Peak Reverse Voltage	Repetitive Peak Reverse Voltage
HU10005*	50V	50V
HU10010*	100V	100V
HU10015*	150V	150V
HU10020*	HU10120*	200V
	HU10130*	300V
	HU10140*	400V
	HU10150*	500V
HU10260*	600V	600V
HU10270*	700V	700V
HU10280*	800V	800V

Add Suffix R for Reverse Polarity

- Ultra Fast Recovery
- 175°C Junction Temperature
- V_{RRM} 50 to 800 Volts
- High surge capacity
- 100 Amp current rating
- ROHS Compliant

Electrical Characteristics

	HU100	HU101	HU102	
Average forward current	$I_F(AV)$ 100A	100A	100A	Square Wave
Case Temperature	T_C 135°C	120°C	115°C	$R_{\theta JC} = 0.5^\circ C/W$
Maximum surge current	I_{FSM} 1500A	1400A	1200A	8.3ms, half sine, $T_J = 175^\circ C$
Max peak forward voltage	V_{FM} .975V	1.25V	1.35V	$I_{FM} = 100A; T_J = 25^\circ C^*$
Max reverse recovery time	t_{rr} 50ns	70ns	90ns	1/2A, 1A, 1/4A, $T_J = 25^\circ C$
Max peak reverse current	I_{RM} —	6.0mA		$V_{RRM}, T_J = 125^\circ C$
Max peak reverse current	I_{RM} —	50 μ A		$V_{RRM}, T_J = 25^\circ C$
Typical Junction capacitance	C_J 575pF	300pF	275pF	$VR = 10V, T_J = 25^\circ C$

*Pulse test: Pulse width 300 μ sec, Duty cycle 2%

Thermal and Mechanical Characteristics

Storage temp range	T_{STG}	-55°C to 175°C
Operating junction temp range	T_J	-55°C to 175°C
Max thermal resistance	$R_{\theta JC}$	0.5°C/W Junction to case
Typical thermal resistance (greased)	$R_{\theta CS}$.012°C/W Case to sink
Terminal Torque		35-40 inch pounds
Mounting base torque – (outside holes)		20-25 inch pounds
Weight		1.1 ounces (32 grams) typical

HU100

Figure 1
Typical Forward Characteristics

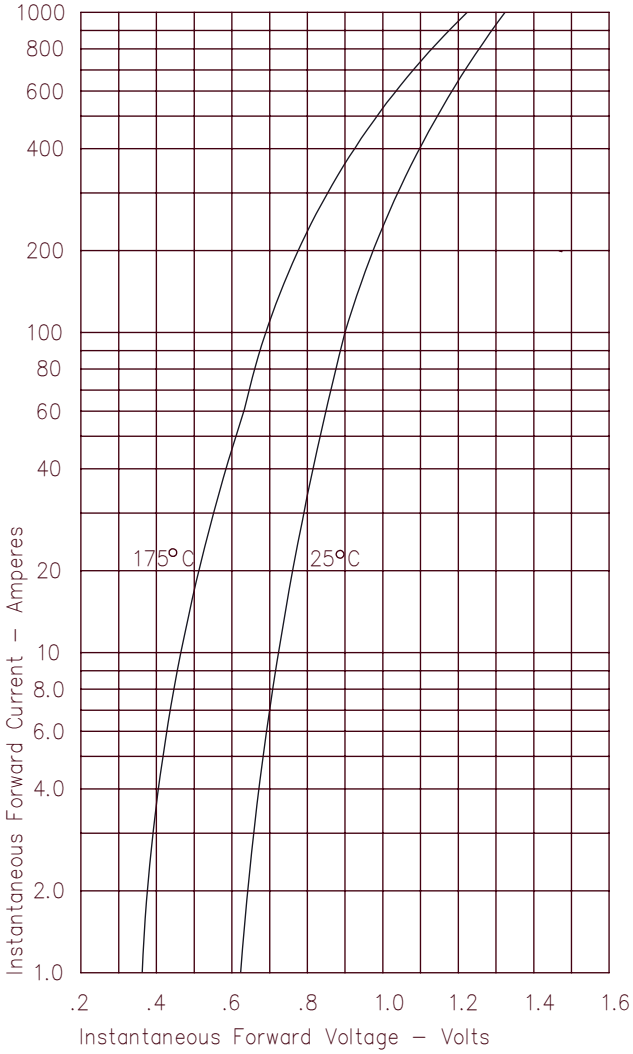

Figure 3
Typical Junction Capacitance

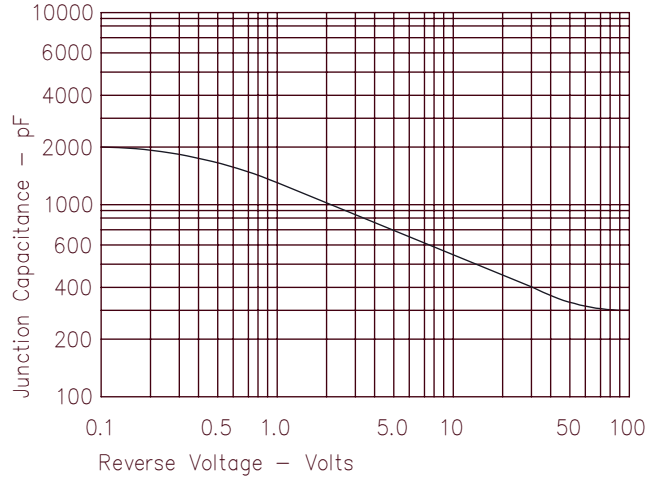

Figure 4
Forward Current Derating

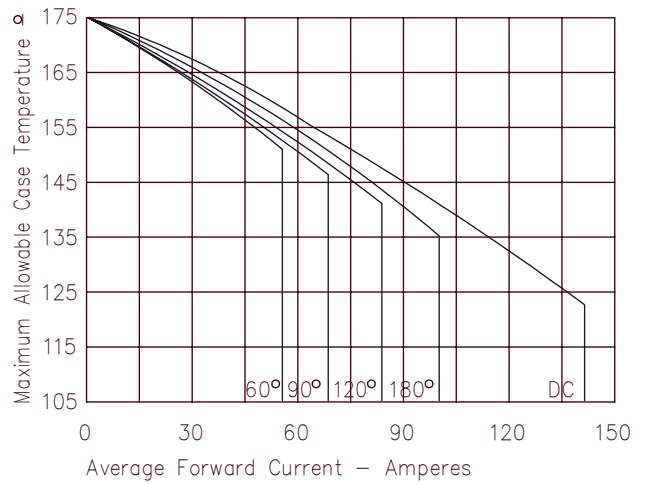

Figure 2
Typical Reverse Characteristics

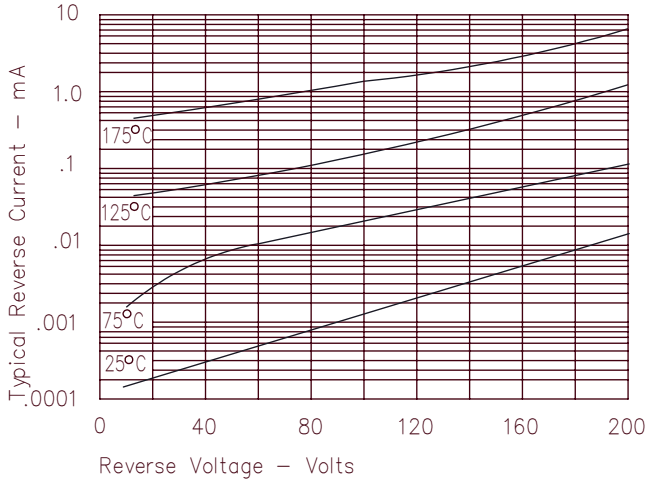
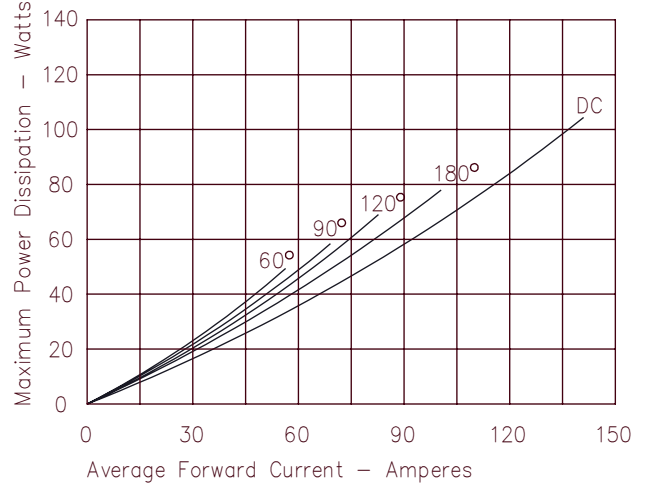

Figure 5
Maximum Forward Power Dissipation



HU101

Figure 1
Typical Forward Characteristics

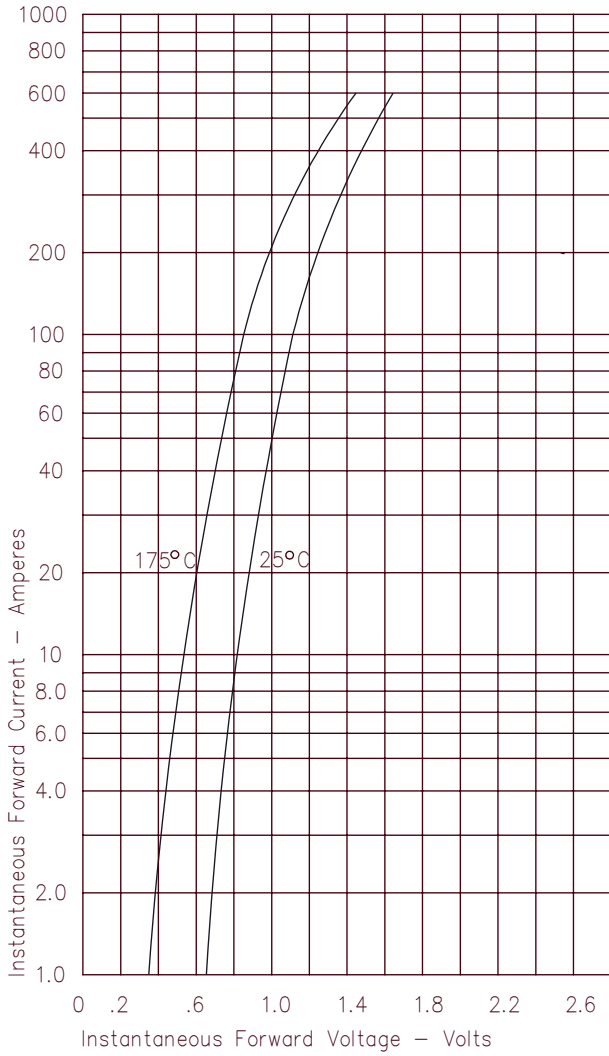

Figure 3
Typical Junction Capacitance

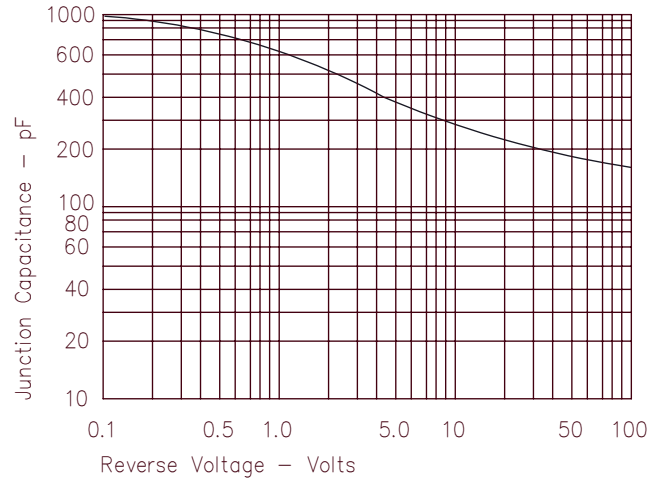

Figure 4
Forward Current Derating

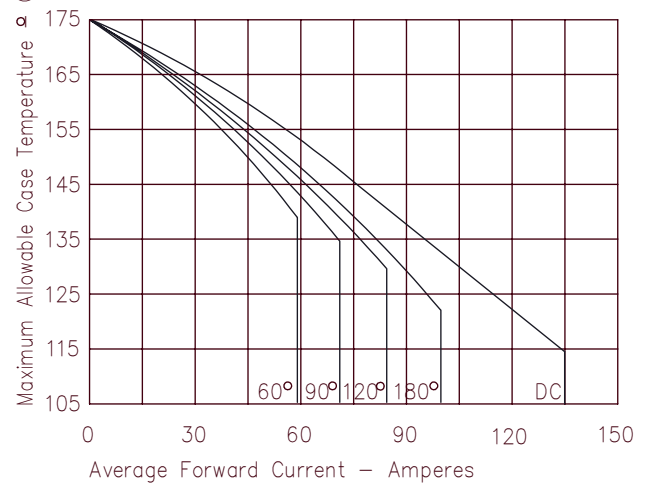

Figure 2
Typical Reverse Characteristics

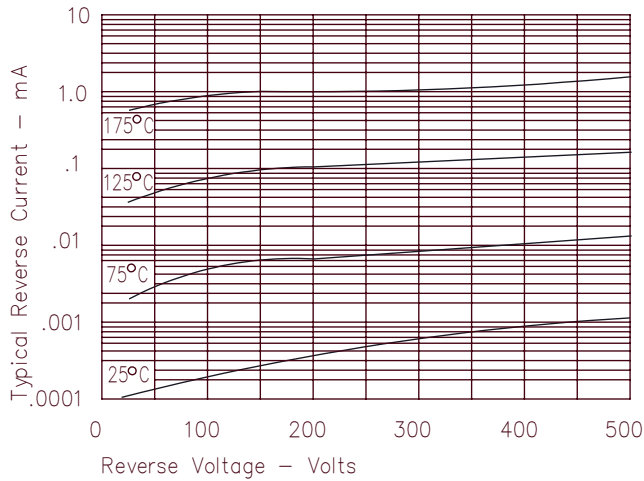
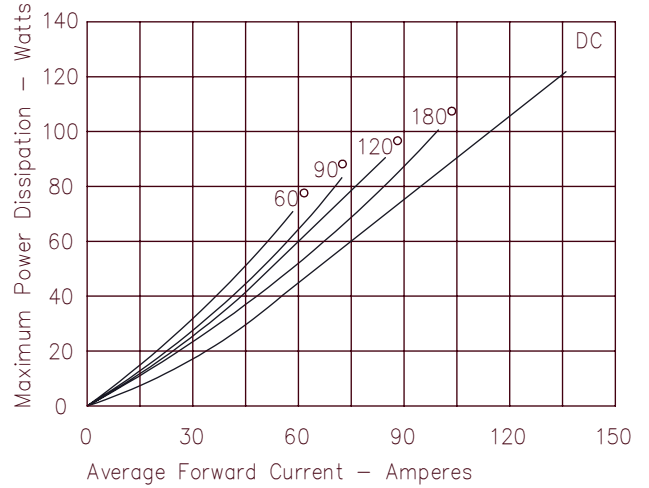

Figure 5
Maximum Forward Power Dissipation



HU102

Figure 1
Typical Forward Characteristics

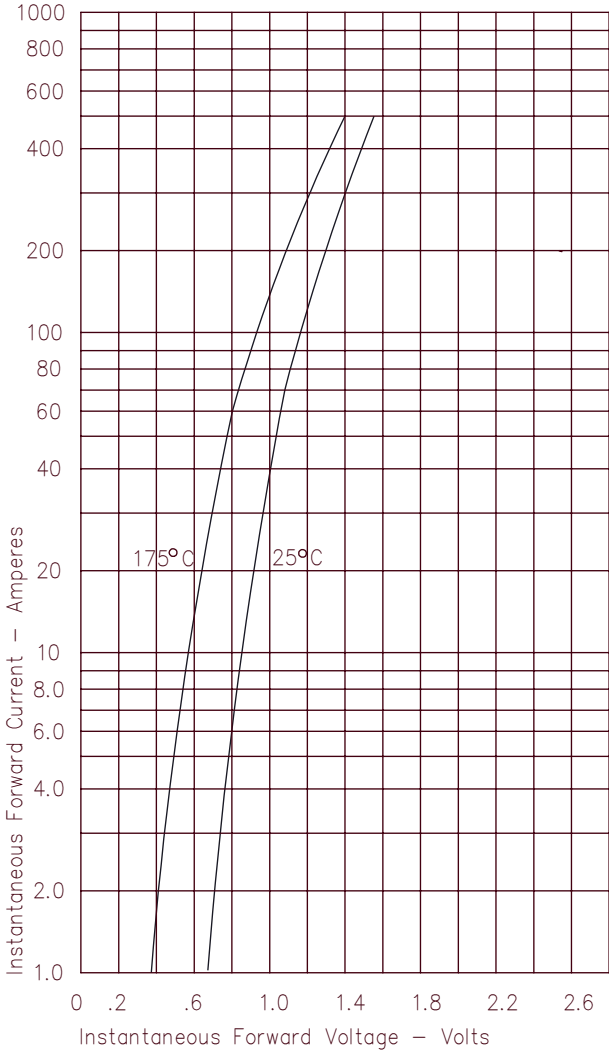

Figure 3
Typical Junction Capacitance

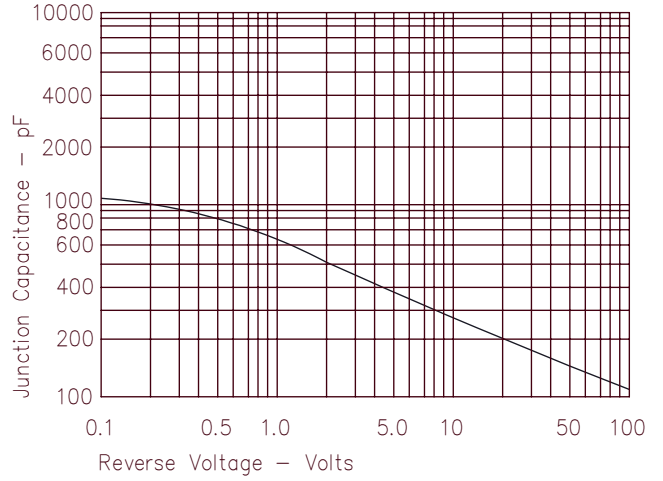

Figure 4
Forward Current Derating

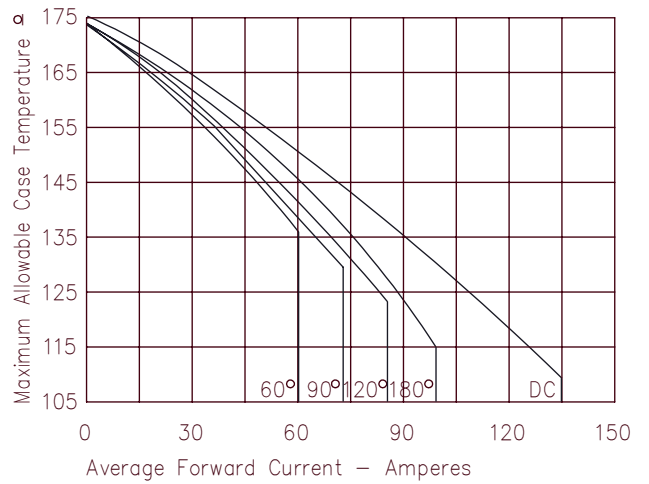

Figure 2
Typical Reverse Characteristics

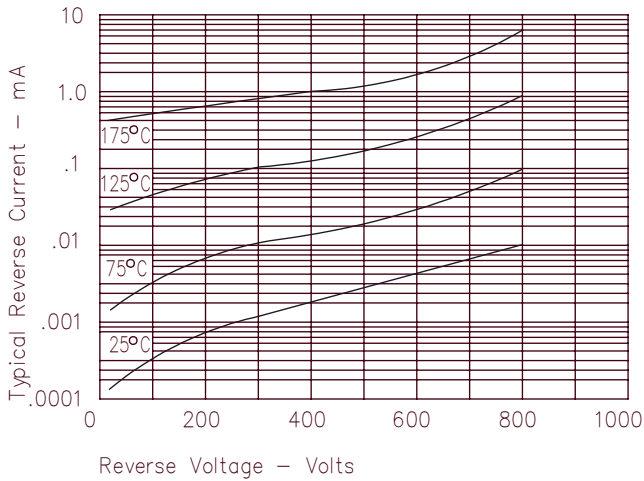

Figure 5
Maximum Forward Power Dissipation

