

Modem and Audio Clock Generator

General Description

The ICS9120-46 is a high performance frequency generator designed to support the clock requirements of communication and audio interfaces. It offers the clock frequencies required by 28.8 baud modem plus sound system. These frequencies are synthesized from 14.7456 MHz reference oscillator whose buffered output is available for the reference.

High accuracy, low-jitter PLLs meet the -96dB signal-to-noise ratios required by 16-bit audio systems. Fast output clock edge rates minimize board induced jitter.

The on-chip XTAL oscillator accuracy is better than ± 100 ppm for an AT cut, 18pF load crystal with initial accuracy of ppm plus TC, aging and load variation of ± 20 ppm each assuming 33pF $\pm 5\%$ external load capacitors.

Features

- Generates 49.92 MHz, 40.32 MHz and 14.7456 MHz
- Single 14.7456 MHz crystal reference
- 49.92 MHz accuracy tracks 40.32 MHz reference
- 80ps one sigma jitter maintains 16-bit performance
- Output rise/fall times less than 1.5ns
- On-chip loop filter components
- 3.0-5.5V supply range
- 8-pin, 150-mil SOIC package

Applications

- Specifically designed to support the high performance requirements of communication and audio interfaces.

Block Diagram

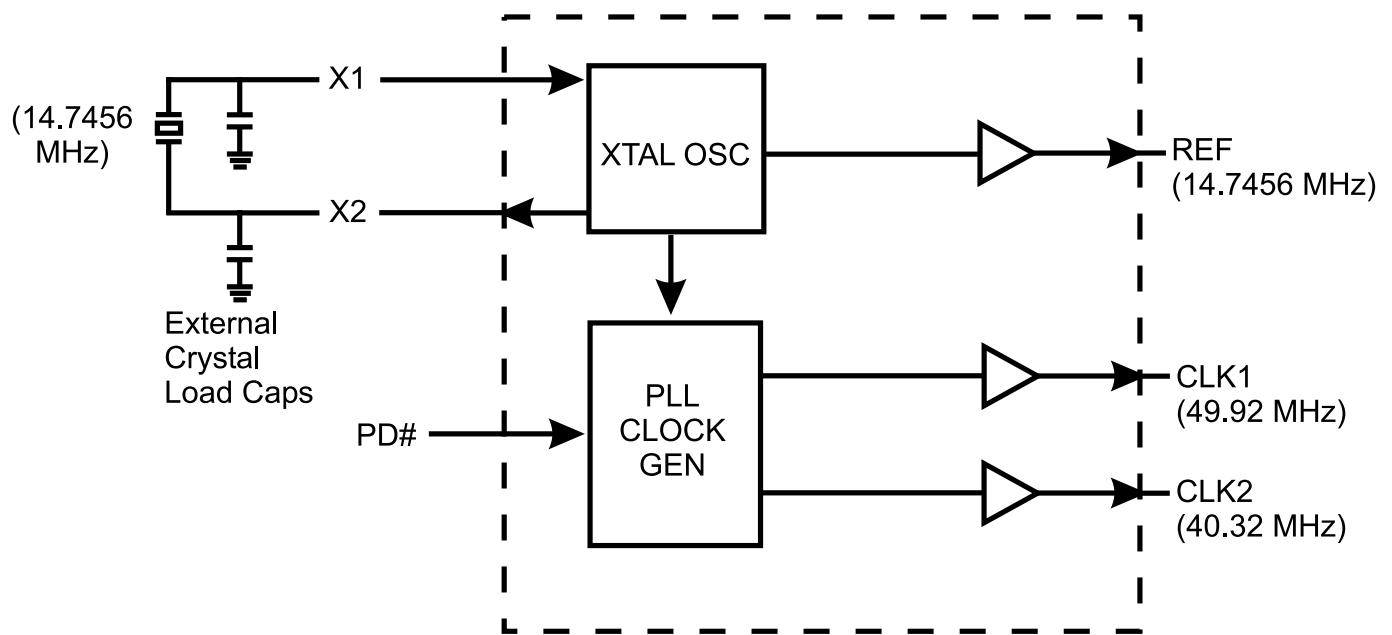

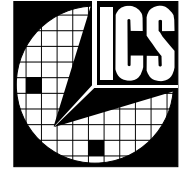

Pin Configuration

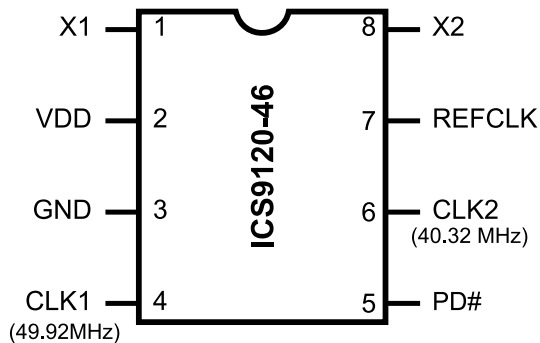

8-Pin SOIC

Functionality

The **ICS9120-46** incorporates a crystal oscillator circuit designed to provide 50% duty cycle over a range of operating conditions, including the addition of external crystal load capacitors to pins X1 and X2.

For the crystal oscillator, the crystal load capacitance must be connected externally by adding a capacitor from each of the X1 and X2 pins to ground. A parallel resonant 14.7456 MHz crystal is recommended.

Duty cycle is also maintained when using an external clock source (connected to X1, X2 left unconnected) as long as the external clock has good duty cycle.

Functionality

X1 (MHz)	PD#	CLK1 (MHz)	CLK2 (MHz)	REF (MHz)
-	0	Low	Low	Low
14.7456	1	49.92	40.32	14.7456

Pin Descriptions for ICS9120-46

PIN NUMBER	PIN NAME	TYPE	DESCRIPTION
1	X1	Input	Crystal or external clock source. Has feedback bias for crystal. Nominally 14.7456<N>MHz input applied. (No internal load cap; must connect external load cap to ground for crystal oscillator.)
2	VDD	Power	+Power supply input.
3	GND	Power	Ground return for Pin 2.
4	CLK1	Output	49.92 MHz target output clock (with nominal 14.7456 MHz input).
5	PD#	Output	Power-down input. All outputs shut off and driven to low output state when this pin is at logic low level. Has pull-up.
6	CLK2	Output	40.32 MHz target output clock.
7	REF	Output	14.7456 MHz reference clock buffered output (with nominal 14.7456 MHz input).
8	X2	Output	Crystal output drive (leave this pin unconnected when using an external clock). (No internal load cap; must connect external load cap to ground for crystal oscillator).

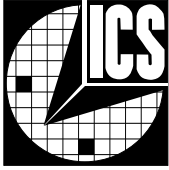

Absolute Maximum Ratings

AVDD, VDD referenced to GND 7V
 Operating temperature under bias 0°C to +70°C
 Storage temperature -65°C to +150°C
 Voltage on I/O pins referenced to GND GND -0.5V to VDD +0.5V
 Power dissipation 0.5 Watts

Stresses above those listed under Absolute Maximum Ratings may cause permanent damage to the device. This is a stress rating only and functional operation of the device at these or any other conditions above those indicated in the operational sections of the specifications is not implied. Exposure to absolute maximum rating conditions for extended periods may affect product reliability.

Electrical Characteristics at 5 V

V_{DD} = +4.5 to +5.5V, T_A = 0 to 70°C unless otherwise stated

DC Characteristics						
PARAMETER	SYMBOL	TEST CONDITIONS	MIN	TYP	MAX	UNITS
Input Low Voltage	V _{IL}		-	-	0.8	V
Input High Voltage	V _{IH}		2.0	-	-	V
Input Low Current	I _{IL}	V _{IN} =0V	-18.0	-8.3	-	μA
Input High Current	I _{IH}	V _{IN} =V _{DD}	-	-	5.0	μA
Output Low Voltage	V _{OL}	IOL=+10mA	-	0.15	0.4	V
Output High Voltage	V _{OH}	IOH=-30mA	2.4	3.7	-	V
Output Low Current	I _{OL}	V _{OL} =0.8V	25.0	45.0	-	mA
Output High Current	I _{OH}	V _{OH} =2.4V	-	-53.0	-35.0	mA
Supply Current	I _{DD}	Unloaded	-	27.0	50.0	mA
Supply Current Power-down	I _{DDPD}	Unloaded; Pin 5=0V	-	500.0	800.0	μA
Pull-up Resistor Value	R _{pu}		-	400.0	800.0	k ohm
AC Characteristics						
Rise Time	T _r	15pF load 0.8 to 2.0V	-	0.8	2.0	ns
Fall Time	T _f *	15pF load 2.0 to 0.8V	-	0.6	1.5	ns
Rise Time	T _r	15pF load 20% to 80%	-	1.7	3.0	ns
Fall Time	T _f	15pF load 80% to 20%	-	1.1	2.5	ns
Duty Cycle	D _t	15pF load @ 50% of VDD; Except REFCLK	45.0	50.0	55.0	%
Duty Cycle	D _t	15pF load @ 50% of VDD; REFCLK only	40.0	45.0	60.0	%
Jitter, One Sigma	T _{jis}	For all frequencies except REFCLK	-	70.0	90.0	ps
Jitter, Absolute	T _{jab}	For all frequencies except REFCLK	300.0	270	300.0	ps
Jitter, One Sigma	T _{jis}	REFCLK only	-	350.0	500.0	ps
Jitter Absolute	T _{jab}	REFCLK only	-1.0	0.8	1.0	ns
Input Frequency Range	F _i		11.0	14.0	17.0	MHz
Output Frequency Range	F _o		11.0	-	58.0	MHz
Power-up Time	T _{pu}	0 to 40.3 MHz	-	5.5	12.0	ms
Crystal Input Capacitance	C _{inx}	X1 (Pin 1), X2 (Pin 8)	-	5	-	pF

*Parameter is guaranteed by design and characterization. Not 100% tested in production.

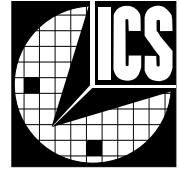

Electrical Characteristics at 3.3 V

$V_{DD} = +3.0$ to $+3.7V$, $T_A = 0^{\circ}C$ - $70^{\circ}C$ unless otherwise stated

DC Characteristics						
PARAMETER	SYMBOL	TEST CONDITIONS	MIN	TYP	MAX	UNITS
Input Low Voltage	V_{IL}		-	-	$0.2V_{DD}$	V
Input High Voltage	V_{IH}		$0.7V_{DD}$	-	-	V
Input Low Current	I_{IL}	$V_{IN}=0V$	-8.0	-3.6	-	μA
Input High Current	I_{IH}	$V_{IN}=V_{DD}$	-	-	5.0	μA
Output Low Voltage	V_{OL}	$I_{OL}=6.0mA$	-	$0.05V_{DD}$	1.1	V
Output High Voltage	V_{OH}	$I_{OH}=4.0mA$	$0.85V_{DD}$	$0.94V_{DD}$	-	V
Output Low Current	I_{OL}	$V_{OL}=0.2V_{DD}$	15.0	24.0	-	mA
Output High Current	I_{OH}	$V_{OH}=0.7V_{DD}$	-	-13.0	-8.0	mA
Supply Current	I_{DD}	Unloaded	-	20.0	40.0	mA
Supply Current Power-down	I_{DDPD}	Unloaded; Pin 5=0V	-	200.0	400.0	μA
Pull-up Resistor Value	R_{pu}		-	620.0	900.0	k ohm
AC Characteristics						
Rise Time	T_r	15pF load 0.8 to 2.0V	-	2.2	3.5	ns
Fall Time	T_f^*	15pF load 2.0 to 0.8V	-	1.2	2.5	ns
Rise Time	T_r	15pF load 20% to 80%	-	2.3	4.0	ns
Fall Time	T_f	15pF load 80% to 20%	-	1.2	3.0	ns
Duty Cycle	D_t	15pF load @ 50% of VDD; Except REFCLK	45.0	50.0	55.0	%
Duty Cycle	D_t	15pF load @ 50% of VDD; REFCLK only	40.0	45.0	60.0	%
Jitter, One Sigma	T_{j1s}	For all frequencies except REFCLK	-	80.0	100.0	ps
Jitter Absolute	T_{jab}	For all frequencies except REFCLK	-350.0	± 300.0	350.0	ps
Jitter, One Sigma	T_{j1s}	REFCLK only	-	380.0	500.0	ps
Jitter, Absolute	T_{jab}	REFCLK only	-1.0	0.8	1.0	ns
Input Frequency Range	F_i		11.0	14.745	15.0	MHz
Output Frequency Range	F_o		14.0	-	51.0	MHz
Power-up Time	T_{pu}	0 to 40.3 MHz	-	5.5	12.0	ms
Crystal Input Capacitance	C_{inx}	X1 (Pin 1), X2 (Pin 8)	-	5	-	pF

*Parameter is guaranteed by design and characterization. Not 100% tested in production.

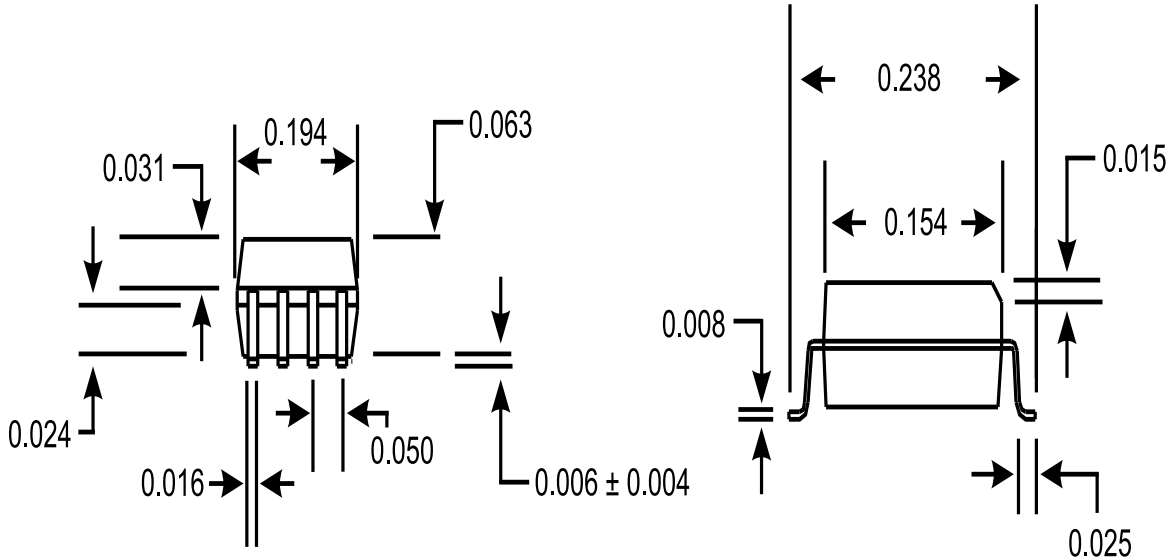
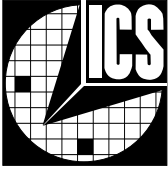

8 Pin SOIC Package

Ordering Information

ICS9120M-46

Example:

ICS XXXX M-PPP

