

# IFX20001

Low Dropout Voltage Regulator

IFX20001MBV33  
IFX20001MBV50

## Data Sheet

Rev. 1.1, 2013-01-08

Standard Power



## 1 Overview

### Features

- Two output voltage versions: 3.3 V, 5.0 V
- Low drop voltage  $\leq 300$  mV over the full temperature range
- Output current: 30 mA
- Inhibit function
- Low quiescent current
- Input voltage up to 45 V
- Wide temperature range:  $-40^{\circ}\text{C} \leq T_j \leq 125^{\circ}\text{C}$
- Output protected against short circuit
- Over temperature protection
- Reverse polarity protection
- Very small and thermally enhanced package
- Green Product (RoHS compliant)

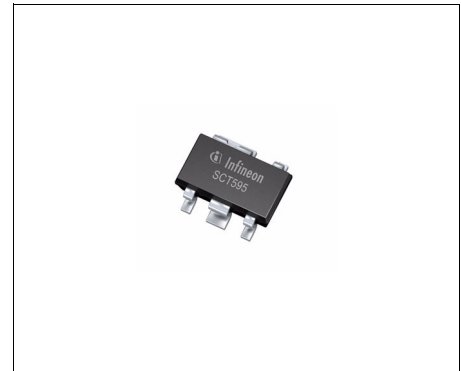

**PG-SCT595-5**

### Applications

- Manufacturing Automation
- Appliances
- Network Routers

The **IFX20001** is not qualified and manufactured according to the requirements of Infineon Technologies with regards to automotive and/or transportation applications. For automotive applications please refer to the Infineon TLx (TLE, TLS, TLF.....) voltage regulator products.

### Description

The **IFX20001** is a monolithic integrated low drop voltage regulator in a very small SMD package PG-SCT595-5. It is designed to supply various loads (e.g. micro controllers, sensors, or as standby supply, etc) under severe conditions. Therefore the device is equipped with additional protection functions against overload, short circuit and reverse polarity. In case of an over temperature condition the regulator is automatically turned off by the integrated thermal protection circuit.

Input voltages up to 40 V are regulated to  $V_{Q,nom} = 3.3$  V (V33 version) or 5.0 V (V50 version). The output is able to drive a load of 30 mA while it regulates the output voltage within a 4% accuracy. To save energy the device can be switched to stand-by mode via an inhibit input which causes the current consumption to drop below 5  $\mu\text{A}$ .

| Type          | Package     | Marking |
|---------------|-------------|---------|
| IFX20001MBV33 | PG-SCT595-5 | V3      |
| IFX20001MBV50 | PG-SCT595-5 | V5      |

## 2 Block Diagram

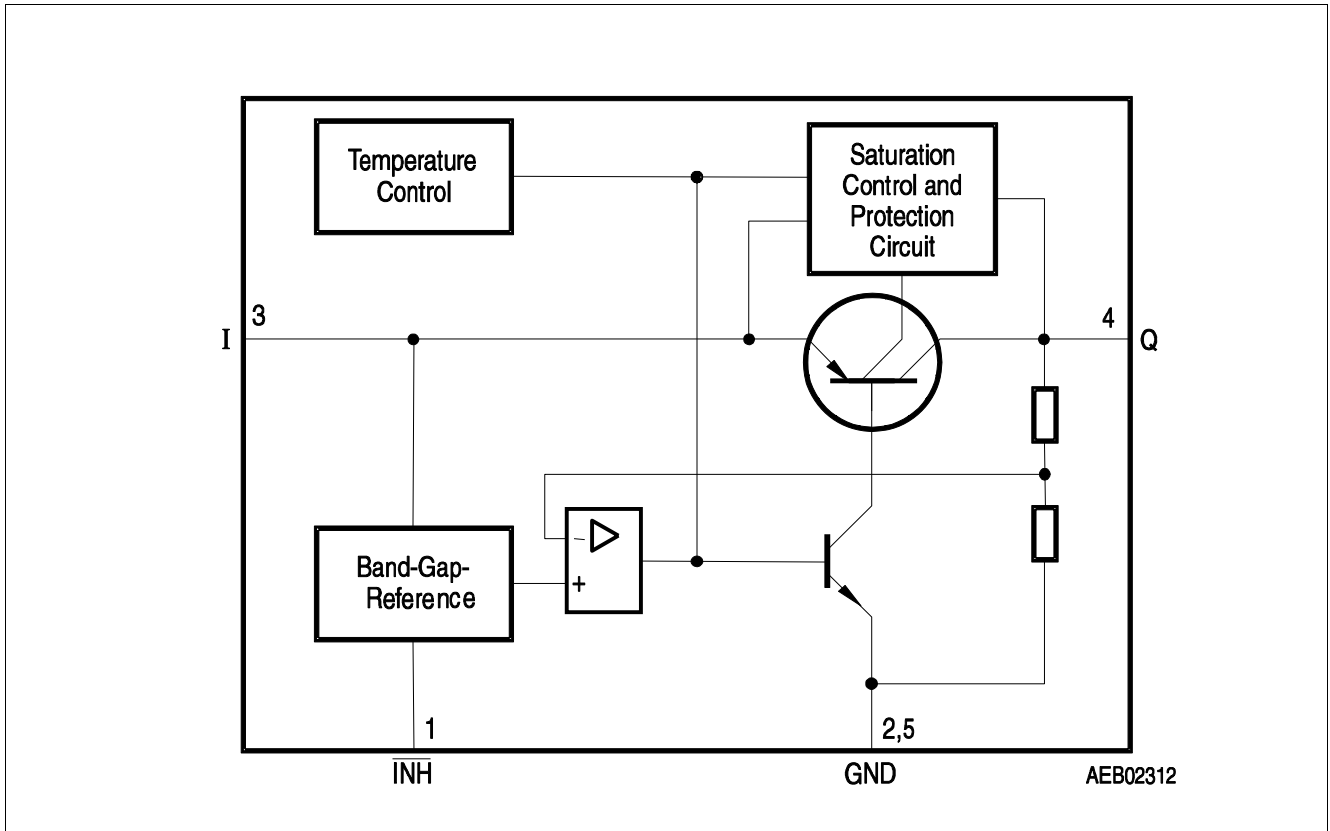

Figure 1 Block Diagram

### 3 Pin Configuration

#### 3.1 Pin Assignment

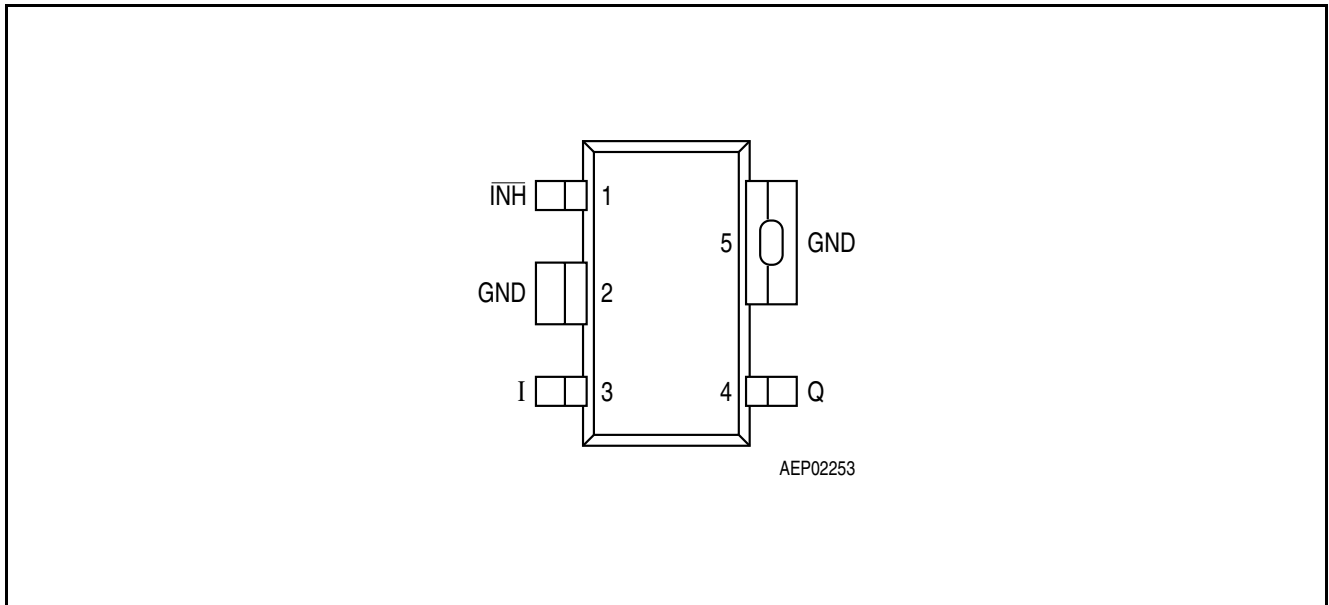

Figure 2 Pin Configuration (top view)

#### 3.2 Pin Definitions and Functions

Table 1 Pin Definitions and Functions Fixed Output Voltage Versions

| Pin No. | Symbol | Function  |
|---------|--------|---|
| 1       | INH    | <b>Inhibit input</b> ; high level to turn on the IC   |
| 2       | GND    | <b>Ground</b> ; connected to pin 5  |
| 3       | I      | <b>Input voltage</b>  |
| 4       | Q      | <b>Output voltage</b> ; must be blocked with a capacitor $C_Q \geq 3.3 \mu\text{F}^{1) 2)}$ |
| 5       | GND    | <b>Ground</b> ; connected to pin 2  |

1) Output capacitor requirements for IFX20001MBV33:  $C_Q \geq 3.3 \mu\text{F}$ ,  $2.5 \Omega \leq \text{ESR} \leq 6 \Omega$

2) Output capacitor requirements for IFX20001MBV50:  $C_Q \geq 3.3 \mu\text{F}$ ,  $2.5 \Omega \leq \text{ESR} \leq 8 \Omega$

## 4 General Product Characteristics

### 4.1 Absolute Maximum Ratings

#### Absolute Maximum Ratings<sup>1)</sup>

$T_j = -40\text{ °C}$  to  $150\text{ °C}$ ; all voltages with respect to ground, (unless otherwise specified)

| Pos.               | Parameter            | Symbol    | Limit Values |      | Unit               | Test Condition   |
|--------------------|----------------------|-----------|--------------|------|--------------------|--|
|                    |                      |           | Min.         | Max. |                    |  |
| <b>Input I</b>     |                      |           |              |      |                    |  |
| 4.1.1              | Voltage              | $V_I$     | -42          | 45   | V                  | –  |
| <b>Output Q</b>    |                      |           |              |      |                    |  |
| 4.1.2              | Voltage              | $V_Q$     | -6           | 30   | V                  | –  |
| <b>Inhibit</b>     |                      |           |              |      |                    |  |
| 4.1.3              | Voltage              | $V_{INH}$ | -42          | 45   | V                  |  |
| 4.1.4              | Current              | $I_{INH}$ | -500         | *    | $\mu\text{A}$      | * internally limited   |
| 4.1.5              | Current              | $I_{INH}$ | -5           | 5    | mA                 | $-0.3\text{ V} < V_I < 45\text{ V}$ ;<br>$t_p < 1\text{ ms}$ |
| <b>Temperature</b> |                      |           |              |      |                    |  |
| 4.1.6              | Junction temperature | $T_j$     | -40          | 150  | $^{\circ}\text{C}$ | –  |
| 4.1.7              | Storage temperature  | $T_{stg}$ | -50          | 150  | $^{\circ}\text{C}$ | –  |

1) not subject to production test, specified by design

*Note: Stresses above the ones listed here may cause permanent damage to the device. Exposure to absolute maximum rating conditions for extended periods may affect device reliability.*

*Note: Integrated protection functions are designed to prevent IC destruction under fault conditions described in the data sheet. Fault conditions are considered as “outside” normal operating range. Protection functions are not designed for continuous repetitive operation.*

## 4.2 Functional Range

| Pos.  | Parameter            | Symbol    | Limit Values |      | Unit | Remarks       |
|-------|----------------------|-----------|--------------|------|------|---------------|
|       |                      |           | Min.         | Max. |      |               |
| 4.2.1 | Input voltage        | $V_I$     | 4.0          | 45   | V    | IFX20001MBV33 |
| 4.2.2 | Input Voltage        | $V_I$     | 5.5          | 45   | V    | IFX20001MBV50 |
| 4.2.3 | Inhibit Voltage      | $V_{INH}$ | -0.3         | 40   | V    |               |
| 4.2.4 | Junction temperature | $T_j$     | -40          | 125  | °C   | –             |

Note: Within the functional or operating range, the IC operates as described in the circuit description. The electrical characteristics are specified within the conditions given in the Electrical Characteristics table.

## 4.3 Thermal Resistance

Note: This thermal data was generated in accordance with JEDEC JESD51 standards. For more information, go to [www.jedec.org](http://www.jedec.org).

| Pos.  | Parameter                   | Symbol      | Limit Values |      |      | Unit | Conditions  |
|-------|-----------------------------|-------------|--------------|------|------|------|---|
|       |                             |             | Min.         | Typ. | Max. |      |   |
| 4.3.5 | Junction to Ambient         | $R_{thJA}$  | –            | 81   | –    | K/W  | 2s2p board <sup>1)</sup>                            |
| 4.3.1 |                             |             | –            | 217  | –    | K/W  | Footprint only <sup>2)</sup>                        |
| 4.3.2 |                             |             | –            | 117  | –    | K/W  | 300 mm <sup>2</sup> PCB heatsink area <sup>2)</sup> |
| 4.3.3 |                             |             | –            | 103  | –    | K/W  | 600 mm <sup>2</sup> PCB heatsink area <sup>2)</sup> |
| 4.3.4 | Junction to Soldering Point | $R_{thJSP}$ | –            | 30   | –    | K/W  | Pins 2, 5 fixed to $T_A$                            |

- 1) Specified  $R_{thJA}$  value is according to JESD51-2,-5,-7 at natural convection on FR4 2s2p board; The product (chip+package) was simulated on a 76.2 x 114.3 x 1.5 mm board with 2 inner copper layers (2 x 70µm Cu, 2 x 35µm Cu). Where applicable a thermal via array under the package contacted the first inner copper layer.
- 2) Package mounted on PCB FR4; 80 x 80 x 1.5 mm; 35 µm Cu, 5 µm Sn; horizontal position; zero airflow. Not subject to production test; specified by design.

## 5 Electrical Characteristics

### 5.1 Electrical Characteristics Voltage Regulator

**Table 2 Electrical Characteristics**
 $V_I = 13.5 \text{ V}; V_{\text{INH}} > +2.5 \text{ V}; -40 \text{ }^\circ\text{C} < T_j < 125 \text{ }^\circ\text{C};$  unless otherwise specified

| Parameter   | Symbol                 | Limit Values |      |      | Unit          | Test Condition   |
|---|------------------------|--------------|------|------|---------------|--|
|   |                        | Min.         | Typ. | Max. |               |  |
| Output voltage<br>V33 version                     | $V_Q$                  | 3.17         | 3.30 | 3.43 | V             | $1 \text{ mA} < I_Q < 30 \text{ mA}$<br>$V_I = 13.5 \text{ V}$   |
|   |                        | 3.17         | 3.30 | 3.43 | V             | $I_Q = 10 \text{ mA}$<br>$4.3 \text{ V} < V_I < 40 \text{ V}$  |
| Output voltage<br>V50 version                     | $V_Q$                  | 4.80         | 5.00 | 5.20 | V             | $1 \text{ mA} < I_Q < 30 \text{ mA}$<br>$V_I = 13.5 \text{ V}$   |
|   |                        | 4.80         | 5.00 | 5.20 | V             | $I_Q = 10 \text{ mA}$<br>$6 \text{ V} < V_I < 40 \text{ V}$  |
| Output current limitation                         | $I_Q$                  | 30           | –    | –    | mA            | 1)   |
| Drop voltage                                      | $V_{\text{dr}}$        | –            | 0.25 | 0.30 | V             | $I_Q = 20 \text{ mA}$ 1)   |
| Output capacitor                                  | $C_Q$                  | 3.3          | –    | –    | $\mu\text{F}$ | IFX20001MBV33:<br>$2.5 \Omega \leq \text{ESR} \leq 6 \Omega$<br>at 10 kHz                                      |
|   | $C_Q$                  | 3.3          | –    | –    | $\mu\text{F}$ | IFX20001MBV50:<br>$2.5 \Omega \leq \text{ESR} \leq 8 \Omega$<br>at 10 kHz                                      |
| Current consumption<br>$I_q = I_I - I_Q$          | $I_q$                  | –            | 2    | 4.5  | mA            | $I_Q < 30 \text{ mA}$  |
| Current consumption<br>$I_q = I_I - I_Q$          | $I_q$                  | –            | 110  | 170  | $\mu\text{A}$ | $I_Q < 1 \text{ mA};$<br>$T_j < 85 \text{ }^\circ\text{C}$   |
| Quiescent current (stand-by)<br>$I_q = I_I - I_Q$ | $I_q$                  | –            | 0    | 1    | $\mu\text{A}$ | $V_{\text{INH}} = 0.4 \text{ V};$<br>$T_j < 85 \text{ }^\circ\text{C}$   |
| Quiescent current (stand-by)<br>$I_q = I_I - I_Q$ | $I_q$                  | –            | 0    | 5    | $\mu\text{A}$ | $V_{\text{INH}} = 0.4 \text{ V}$   |
| Load regulation                                   | $\Delta V_Q$           | –            | 10   | 20   | mV            | $1 \text{ mA} < I_Q < 25 \text{ mA};$<br>$T_j = 25 \text{ }^\circ\text{C}$                                     |
| Line regulation                                   | $\Delta V_Q$           | –            | 5    | 20   | mV            | $V_I = (V_{Q,\text{nom}} + 0.5 \text{ V})$ to<br>36 V<br>$I_Q = 5 \text{ mA}; T_j = 25 \text{ }^\circ\text{C}$ |
| Power Supply Ripple Rejection                     | $PSRR$                 | –            | 60   | –    | dB            | $f_r = 100 \text{ Hz};$<br>$V_r = 0.5 \text{ V}_{\text{pp}}$   |
| <b>Inhibit Input</b>                              |                        |              |      |      |               |  |
| Inhibit, Turn-on voltage                          | $V_{\text{INH, high}}$ | –            | –    | 2.2  | V             | $V_Q > 0.95 V_{Q,\text{nom}}$  |
| Inhibit, Turn-off voltage                         | $V_{\text{INH, low}}$  | 0.4          | –    | –    | V             | $V_Q > 0.1 \text{ V}$  |
| H-input current                                   | $I_{\text{INH, high}}$ | –            | 8    | 12   | $\mu\text{A}$ | $V_{\text{INH}} = 5 \text{ V}$   |
| L-input current                                   | $I_{\text{INH, low}}$  | -2           | –    | 2    | $\mu\text{A}$ | $V_{\text{INH}} = 0 \text{ V}$   |

1) Measured when the output voltage  $v_Q$  has dropped 100 mV from the nominal value.

### 5.2 Typical Performance Characteristics Voltage Regulator

Output Voltage  $V_Q$  versus Input Voltage  $V_I$

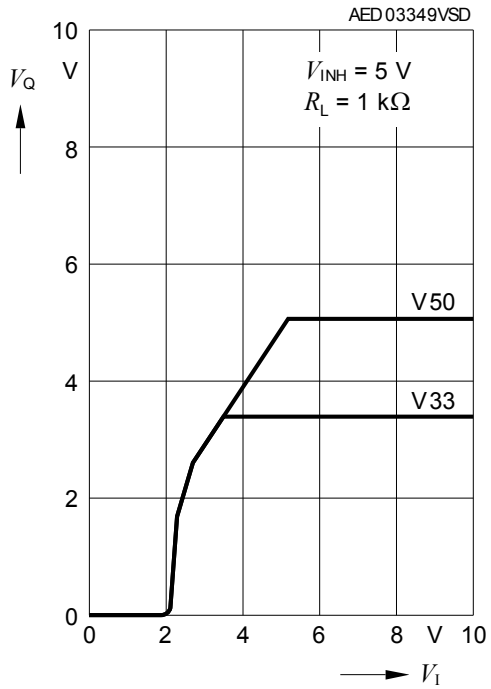

Current Consumption  $I_q$  versus Input Voltage  $V_I$

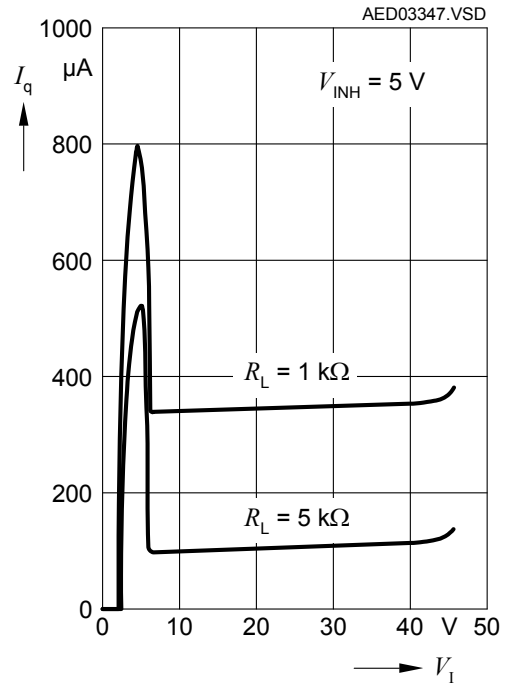



## 6 Application Information

Note: The following information is given as a hint for the implementation of the device only and shall not be regarded as a description or warranty of a certain functionality, condition or quality of the device.

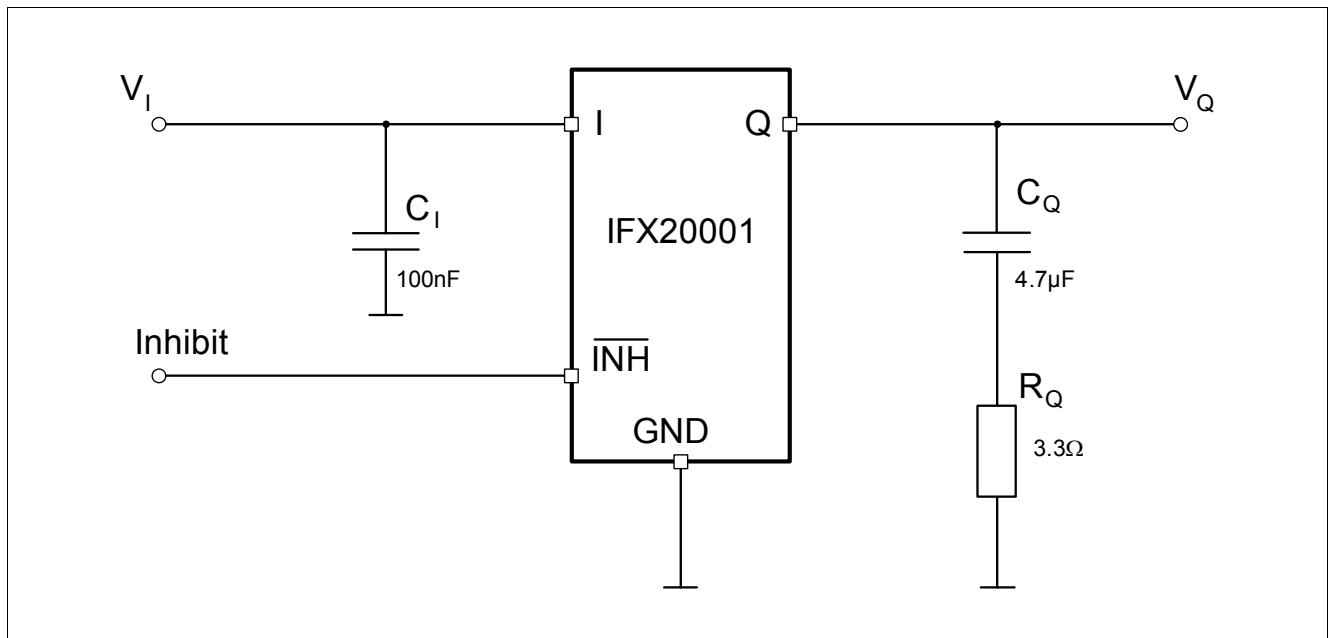

Figure 3 Application Diagram

### Application Information

The output voltage of the IFX20001 is divided and compared to an internal reference of 2.5 V typical. A regulation loop controls the output to achieve a stabilized output voltage.

**Figure 3** shows a typical application circuit. In order to maintain the stability of the control loop the IFX20001 output requires an output capacitor  $C_Q$  of at least 3.3  $\mu\text{F}$  with a minimum required ESR of 2.5  $\Omega$  and a maximum allowed ESR of 6  $\Omega$  for the IFX20001MBV33 and 8  $\Omega$  for the IFX20001MBV50. It is recommended to use for  $C_Q$  a suitable tantalum capacitor or a multilayer ceramic capacitor with a sufficiently dimensioned series resistor in order to cover the required ESR range over the full operating temperature range from -40  $^{\circ}\text{C}$  to 125  $^{\circ}\text{C}$ .<sup>1)</sup>

At the input of the regulator a capacitor is required for compensating line influences. A resistor of approximately 1  $\Omega$  in series with the input capacitor ( $C_I$ ) can dampen oscillations that could occur due to the input line inductance and the input capacitor.

1) For usage of ceramic capacitors without applying an additional series resistor at the output please refer to the **IFX20002** which is a corresponding voltage regulator series specially designed for the usage of low-ESR output capacitors (< 2 $\Omega$ ).

## 7 Package Outlines

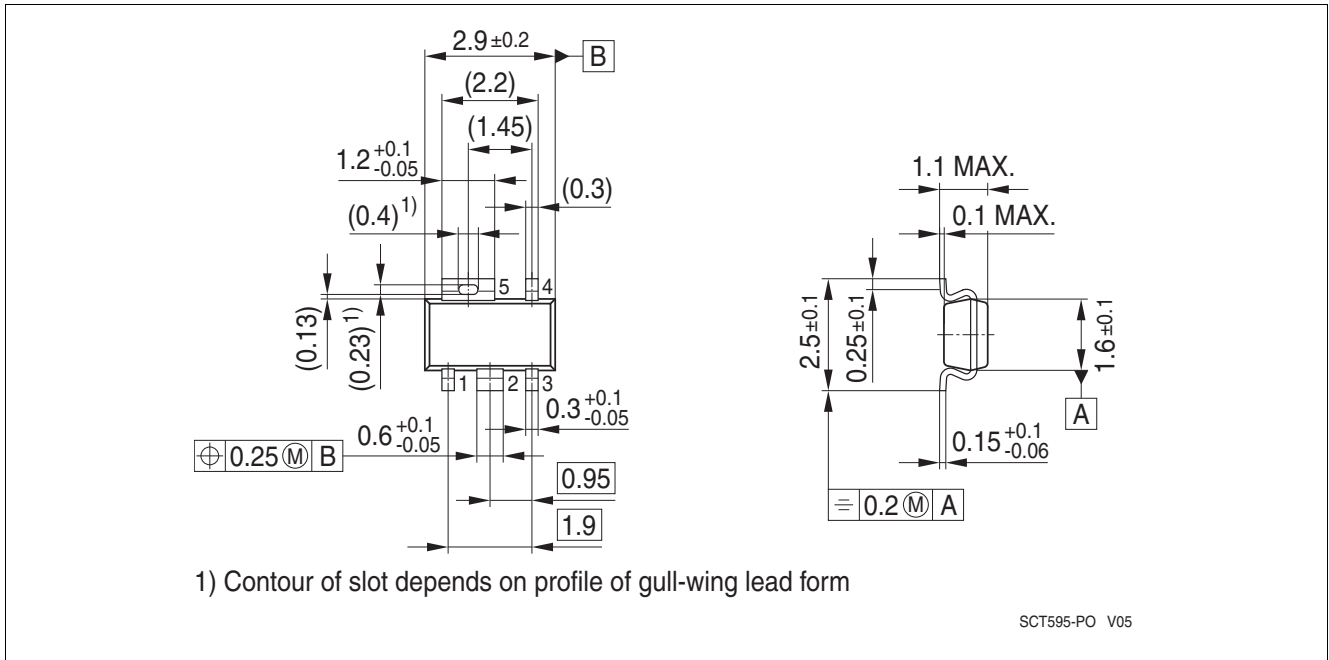

Figure 4 PG-SCT595-5

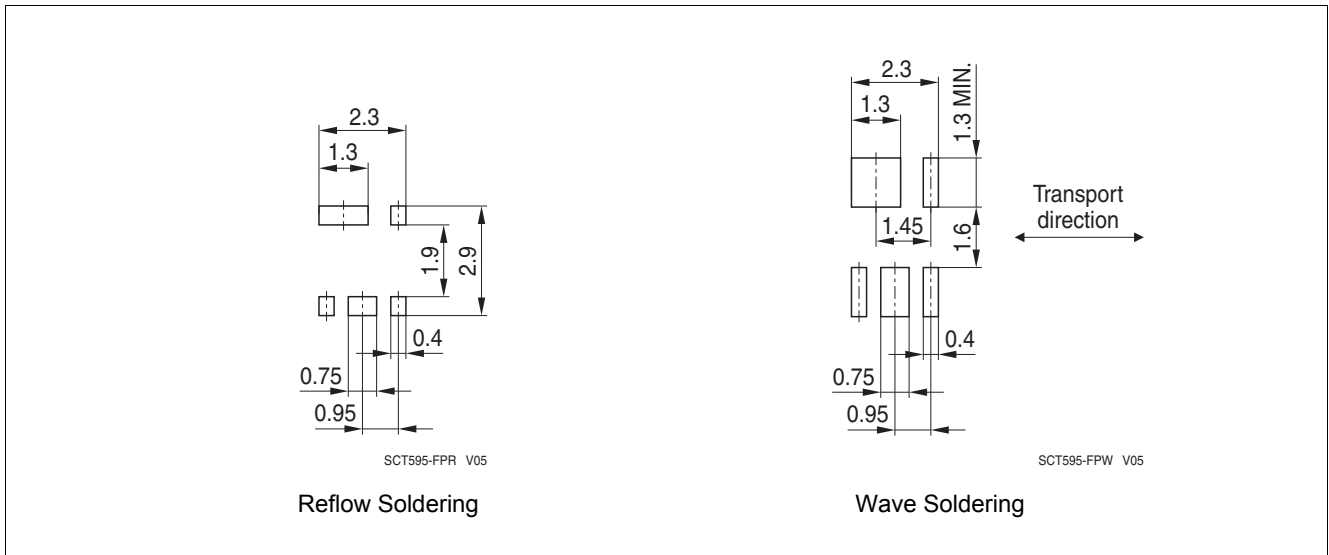

Figure 5 Footprint PG-SCT595-5

### Green Product (RoHS compliant)

To meet the world-wide customer requirements for environmentally friendly products and to be compliant with government regulations the device is available as a green product. Green products are RoHS-Compliant (i.e Pb-free finish on leads and suitable for Pb-free soldering according to IPC/JEDEC J-STD-020).

For further information on packages, please visit our website:

<http://www.infineon.com/packages>.

Dimensions in mm

## 8 Revision History

| Revision | Date       | Changes  |
|----------|------------|--|
| 1.1      | 2013-01-08 | Corrected ESR requirements for output capacitor (chapt. 3.2, table1 / chapt. 5.1, table2 / chapt. 6, "Application Information").<br>remarks/footnotes with respect to ESR added (chapt.6).<br>Updated application diagram (fig.3).<br>Updated (improved) limits of parameters current consumption, line regulation and load regulation in electrical characteristics (chapt. 5.1, table 2). Test condition for current consumption adapted.<br>Updated minimum limit for absolute maximum ratings of $V_Q$ (chapt. 4.1).<br>Further editorial changes. |
| 1.02     | 2010-05-20 | Editorial change (fig.3)   |
| 1.01     | 2009-09-10 | Coverpage changed<br>Overview page: Inserted reference statement to TLE/TLF series.  |
| 1.0      | 2009-04-28 | Initial Release  |

**Edition 2013-01-08**

**Published by  
Infineon Technologies AG  
81726 Munich, Germany**

**© 2013 Infineon Technologies AG  
All Rights Reserved.**

### **Legal Disclaimer**

The information given in this document shall in no event be regarded as a guarantee of conditions or characteristics. With respect to any examples or hints given herein, any typical values stated herein and/or any information regarding the application of the device, Infineon Technologies hereby disclaims any and all warranties and liabilities of any kind, including without limitation, warranties of non-infringement of intellectual property rights of any third party.

### **Information**

For further information on technology, delivery terms and conditions and prices, please contact the nearest Infineon Technologies Office ([www.infineon.com](http://www.infineon.com)).

### **Warnings**

Due to technical requirements, components may contain dangerous substances. For information on the types in question, please contact the nearest Infineon Technologies Office.

The Infineon Technologies component described in this Data Sheet may be used in life-support devices or systems and/or automotive, aviation and aerospace applications or systems only with the express written approval of Infineon Technologies, if a failure of such components can reasonably be expected to cause the failure of that life-support automotive, aviation and aerospace device or system or to affect the safety or effectiveness of that device or system. Life support devices or systems are intended to be implanted in the human body or to support and/or maintain and sustain and/or protect human life. If they fail, it is reasonable to assume that the health of the user or other persons may be endangered.