

# Low Power J-FET DUAL OPERATIONAL AMPLIFIERS

**IL072**

The IL072 are high speed J-FET input dual operational amplifiers incorporating well matched, high voltage J-FET and bipolar transistors in a monolithic integrated circuit.

The devices feature high slew rates, low input bias and offset current, and low offset voltage temperature coefficient.

- Low power consumption
- Wide common-mode and differential voltage range
- Low input bias and offset currents
- Low noise  $e_n=18 \text{ nV}/\sqrt{\text{Hz}}$  (typ)
- Output short-circuit protection
- High input impedance J-FET input stage
- Low harmonic distortion: 0.01% (typ)
- Internal frequency compensation
- Latch up free operation
- High slew rate:  $13 \text{ V}/\mu\text{s}$  (typ)

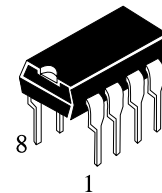

N SUFFIX  
PLASTIC

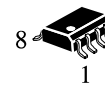

D SUFFIX  
SOIC

**ORDERING INFORMATION**

IL072N Plastic

IL072D SOIC

$T_A = -40^\circ \text{ to } 85^\circ \text{ C}$  for package

**Pin Connections (top view)**

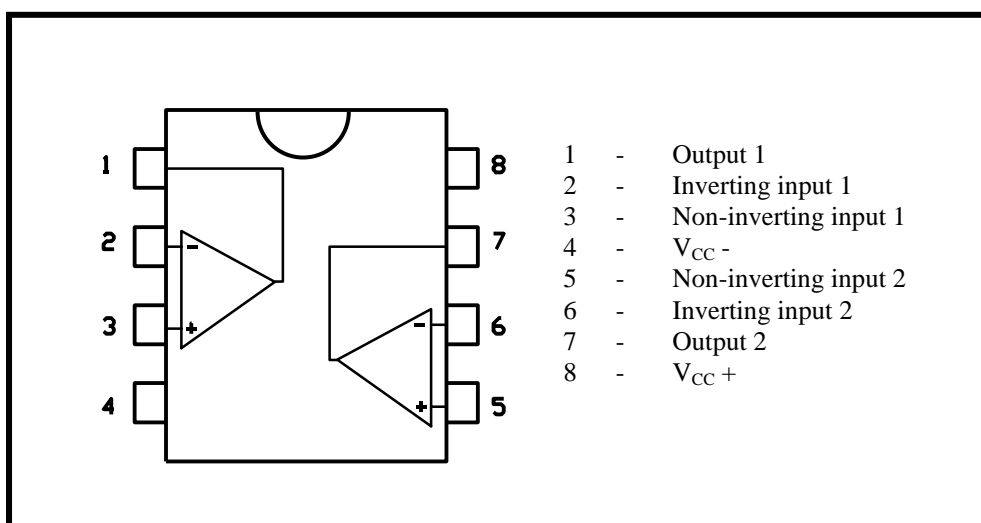

**SCHEMATIC DIAGRAM**

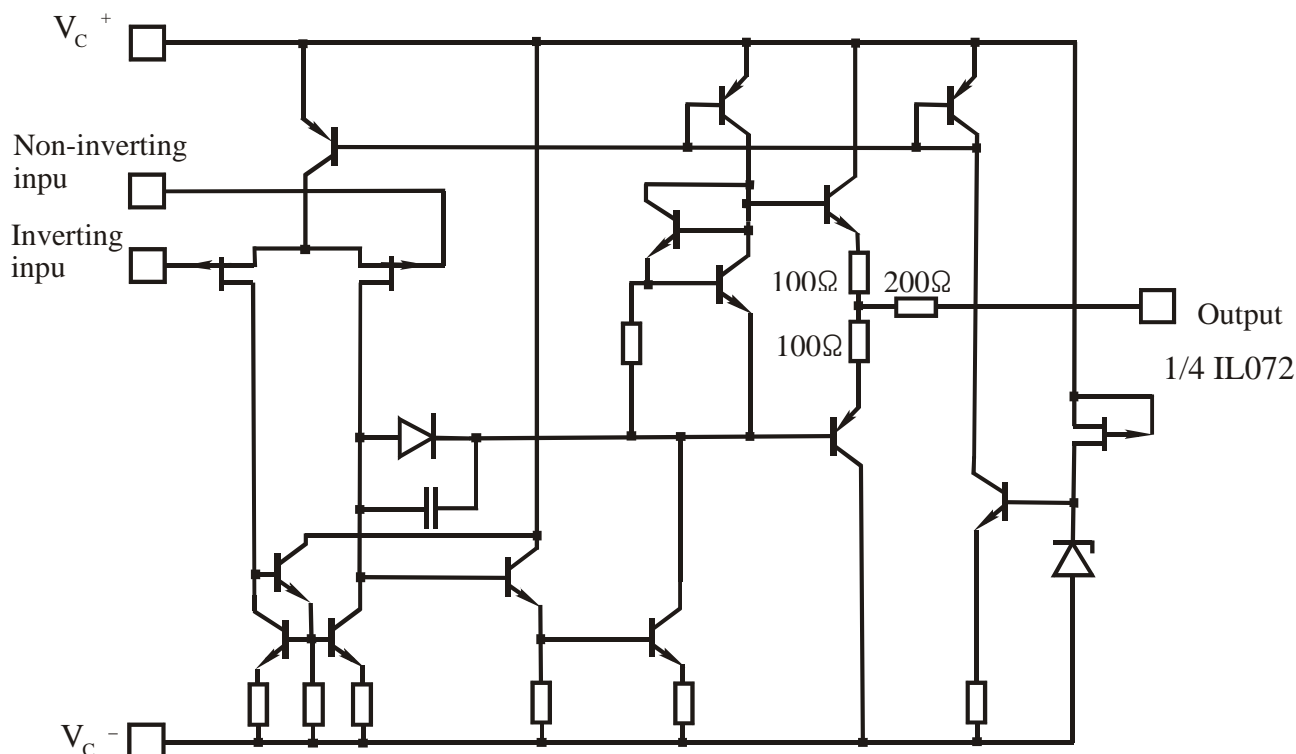

**MAXIMUM RATING**

Symbol	Parameter	IL072	Unit
V <sub>CC</sub>	Supply Voltage – (note 1)	±18	V
V <sub>i</sub>	Input Voltage – (note 3)	±15	V
V <sub>id</sub>	Differential Input Voltage – (note 2)	±30	V
P <sub>tot</sub>	Power Dissipation	680	mW
	Output Short-Circuit Duration (Note 4)	Infinite	
T <sub>oper</sub>	Operating Free-Air Temperature Range	-40 to 85	°C
T <sub>stg</sub>	Storage Temperature Range	-65 to +150	°C

- Notes
1. All voltage values, except differential voltage, are with respect to the zero reference level (ground) of the supply voltages where the zero reference level is the midpoint between V<sub>CC</sub><sup>+</sup> and V<sub>CC</sub><sup>-</sup>.
  2. Differential voltages are at the non-inverting input terminal with respect to the inverting input terminal.
  3. The magnitude of the input voltage must never exceed the magnitude of the supply voltage or 15 volts, whichever is less.
  4. The output may be shorted to ground or to either supply. Temperature and/or supply voltages must be limited to ensure that the dissipation rating is not exceeded.

**ELECTRICAL CHARACTERISTICS**
 $V_{CC} = \pm 15V$ ,  $T_{AMB} = 25^{\circ}C$  (unless otherwise specified)

Symbol	Parameters	IL072			Unit
		Min.	Typ.	Max.	
$V_{IO}$	Input Offset Voltage ( $R_S = 50\Omega$ , $V_0=0$ ) $T_{amb} = 25^{\circ}C$ $T_{min.} \leq T_{amb.} \leq T_{max.}$		3	10 13	mV
$DV_{IO}$	Input Offset Voltage Drift		18		$\mu V/^{\circ}C$
$I_{IO}$	Input Offset Current* $T_{amb} = 25^{\circ}C$ $T_{min.} \leq T_{amb.} \leq T_{max.}$		5	100 10	pA nA
$I_{IB}$	Input Bias Current* $T_{amb} = 25^{\circ}C$ $T_{min.} \leq T_{amb.} \leq T_{max.}$		65	200 20	pA nA
$A_{VD}$	Large Signal Voltage Gain ( $R_L = 2k\Omega$ , $V_0 = \pm 10V$ ) $T_{amb} = 25^{\circ}C$ $T_{min.} \leq T_{amb.} \leq T_{max.}$	25 15	200		V/mV
SVR	Supply Voltage Rejection Ratio ( $R_S = 50\Omega$ , $V_0=0$ ) $T_{amb} = 25^{\circ}C$ $T_{min.} \leq T_{amb.} \leq T_{max.}$	70 70	86		dB
$I_{CC}$	Supply Current (Per Amplifier) $T_{amb} = 25^{\circ}C$ $T_{min.} \leq T_{amb.} \leq T_{max.}$		1.4	2.5 2.5	mA
$V_{ICM}$	Input Common Mode Voltage Range	$\pm 11$	+15 -12		V
CMR	Common Mode Rejection Ratio ( $R_S = 50\Omega$ , $V_0=0$ ) $T_{amb} = 25^{\circ}C$	70	86		dB
$\pm V_{OPP}$	Output Voltage Swing $T_{amb} = 25^{\circ}C$ $R_L = 10k\Omega$ $T_{min.} \leq T_{amb.} \leq T_{max.}$ $R_L = 2k\Omega$ $R_L = 10k\Omega$	12 10 12	13.5		V
SR	Slew Rate ( $V_i = 10V$ , $R_L = 2k\Omega$ , $C_L = 100pF$ , $T_{amb} = 25^{\circ}C$ , unity gain)	8	13		V/ $\mu s$
$t_r$	Rise Time ( $V_i = 20mV$ , $R_L = 2k\Omega$ , $C_L = 100pF$ , $T_{amb} = 25^{\circ}C$ , unity gain)		0.1		$\mu s$
$K_{OV}$	Overshoot ( $V_i = 20mV$ , $R_L = 2k\Omega$ , $C_L = 100pF$ , $T_{amb} = 25^{\circ}C$ , unity gain)		20		%
GBP	Gain Bandwidth Product		3		MHz
$R_I$	Input Resistance		$10^{12}$		$\Omega$
THD	Total Harmonic Distortion ( $f=1kHz$ , $R_L = 2k\Omega$ , $T_{amb} = 25^{\circ}C$ )		0.01		%
$e_n$	Equivalent input Noise Voltage ( $R_S = 100\Omega$ , $f = 1KHz$ )		18		$\frac{nV}{\sqrt{Hz}}$
$V_{O1}/V_{O2}$	Channel Separation ( $A_V = 100$ )		120		dB

\* The Input bias currents are junction leakage currents which approximately double for every  $10^{\circ}C$  increase in the junction temperature.

**MAXIMUM PEAK-TO-PEAK OUTPUT VOLTAGE versus FREQUENCY**

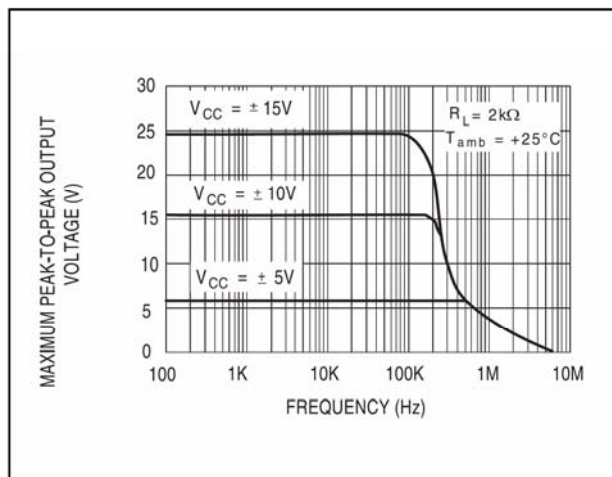

**MAXIMUM PEAK-TO-PEAK OUTPUT VOLTAGE versus FREQUENCY**

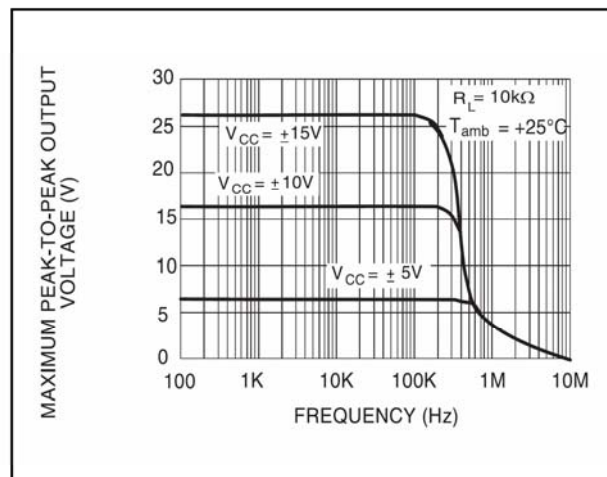

**MAXIMUM PEAK-TO-PEAK OUTPUT VOLTAGE versus FREQUENCY**

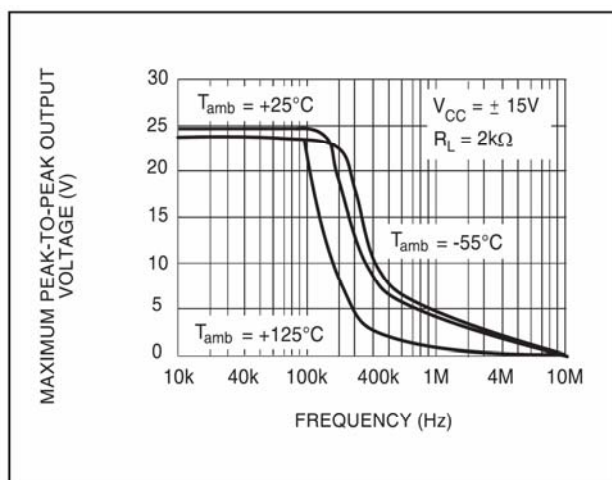

**MAXIMUM PEAK-TO-PEAK OUTPUT VOLTAGE versus FREE AIR TEMP.**

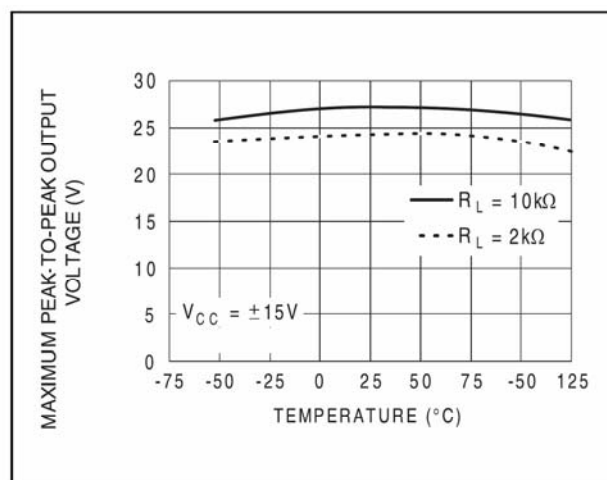

**MAXIMUM PEAK-TO-PEAK OUTPUT VOLTAGE versus LOAD RESISTANCE**

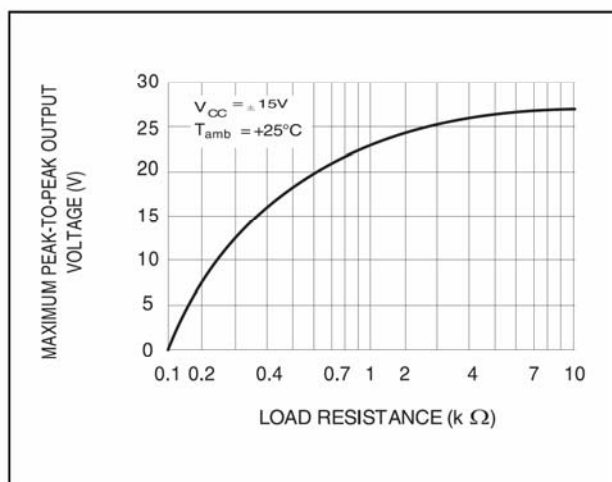

**MAXIMUM PEAK-TO-PEAK OUTPUT VOLTAGE versus SUPPLY VOLTAGE**

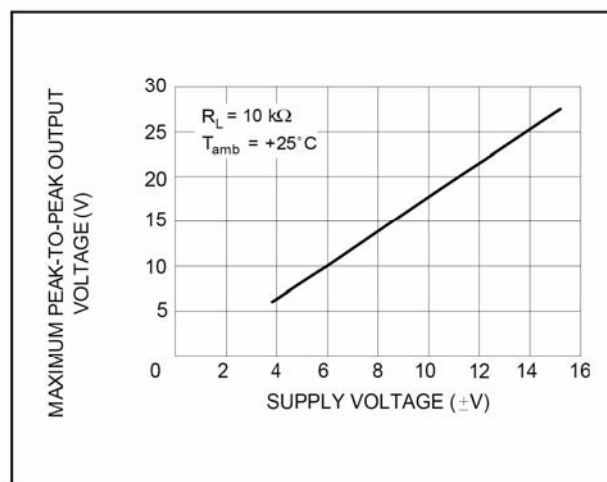

**INPUT BIAS CURRENT versus FREE AIR TEMPERATURE**

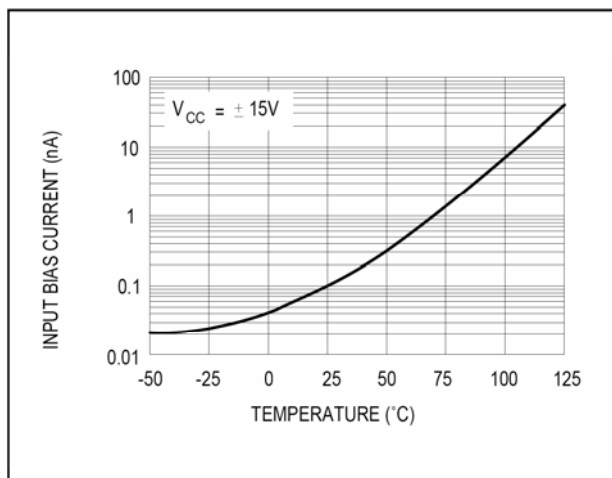

**LARGE SIGNAL DIFFERENTIAL VOLTAGE AMPLIFICATION versus FREE AIR TEMP.**

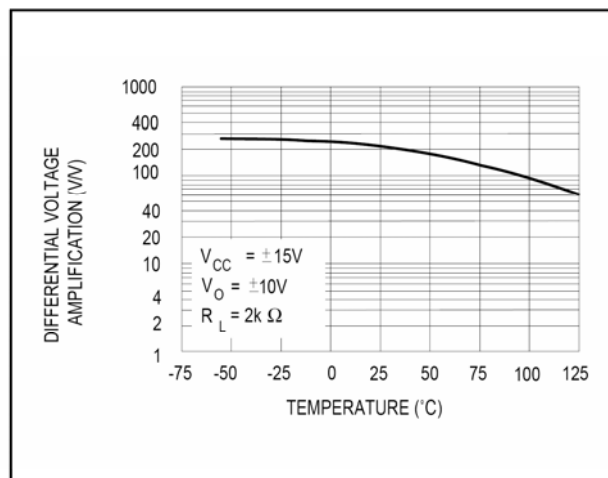

**LARGE SIGNAL DIFFERENTIAL VOLTAGE AMPLIFICATION AND PHASE SHIFT versus FREQUENCY**

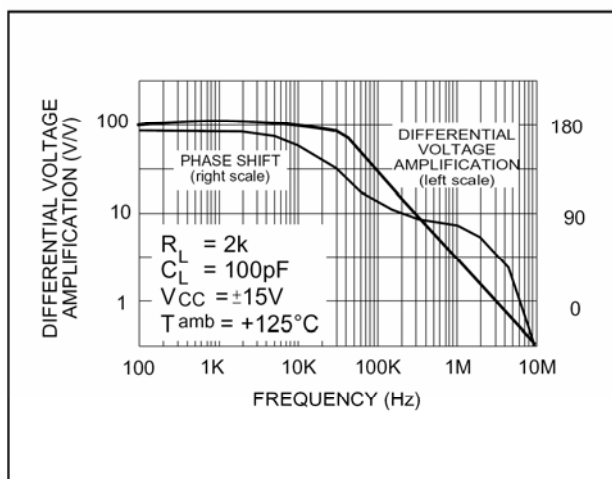

**TOTAL POWER DISSIPATION versus FREE AIR TEMPERATURE**

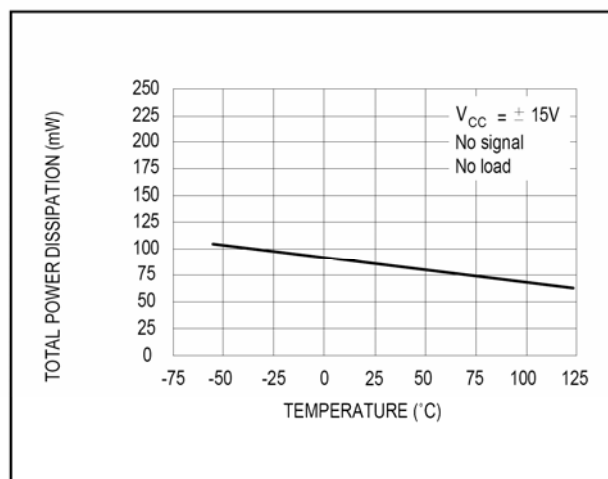

**SUPPLY CURRENT PER AMPLIFIER versus FREE AIR TEMPERATURE**

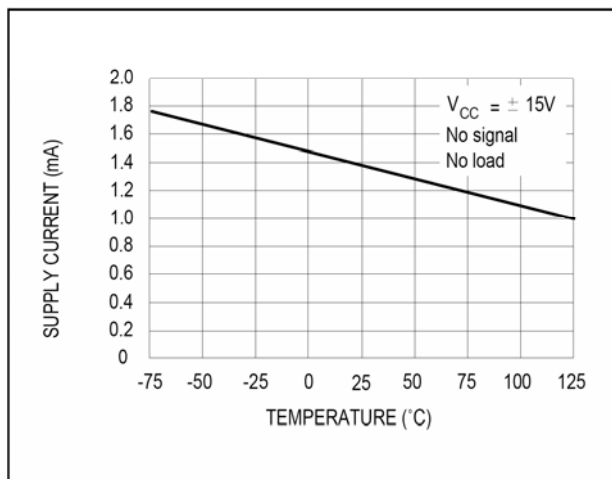

**COMMON MODE REJECTION RATIO versus FREE AIR TEMPERATURE**

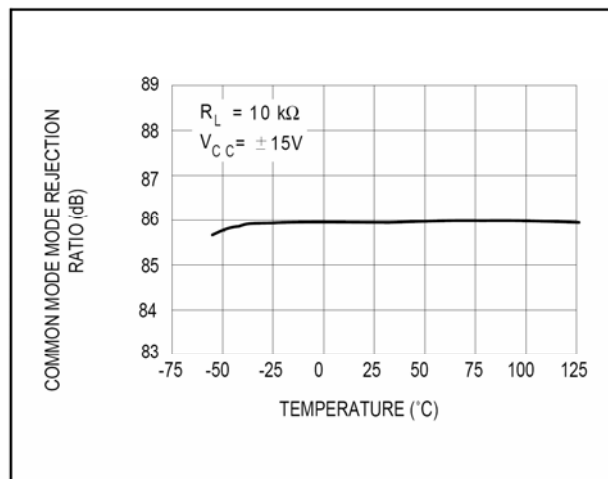

**VOLTAGE FOLLOWER LARGE SIGNAL PULSE RESPONSE**

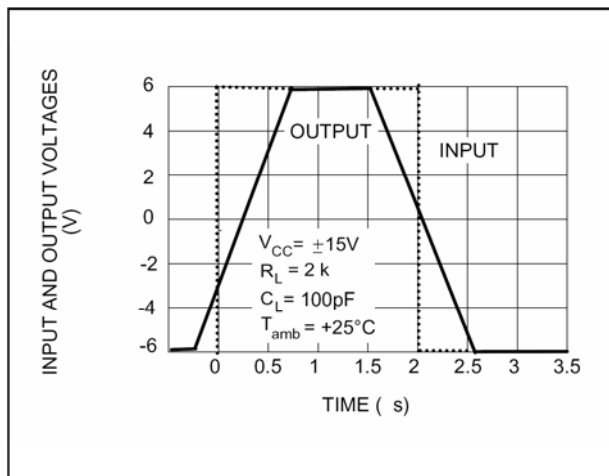

**OUTPUT VOLTAGE versus ELAPSED TIME**

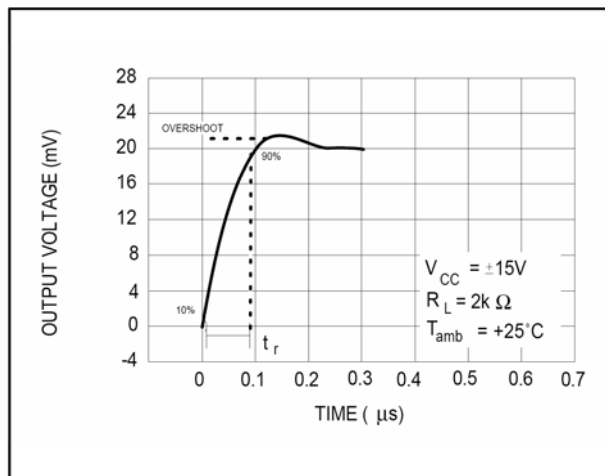

**EQUIVALENT INPUT NOISE VOLTAGE versus FREQUENCY**

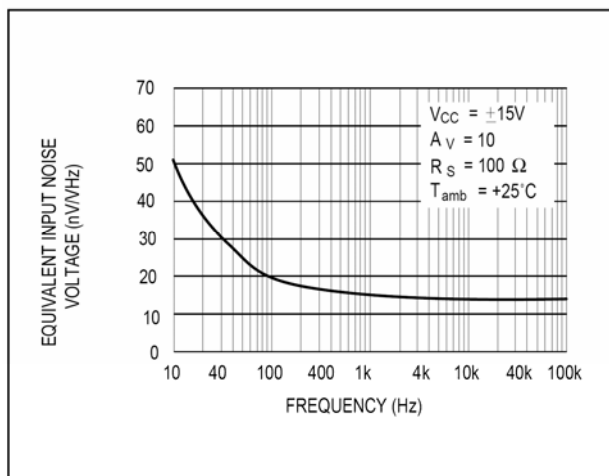

**TOTAL HARMONIC DISTORTION versus FREQUENCY**

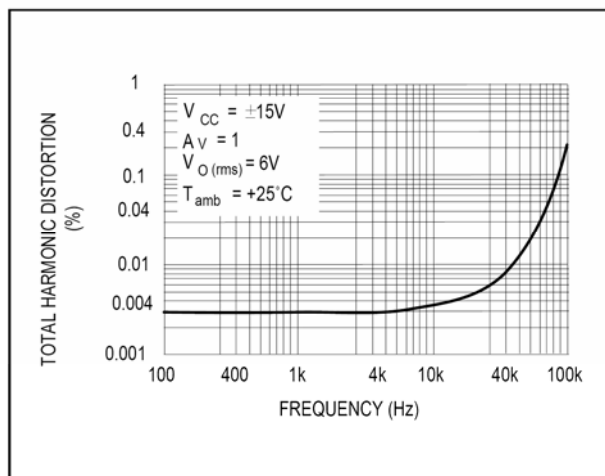

**N SUFFIX PLASTIC DIP  
(MS - 001BA)**

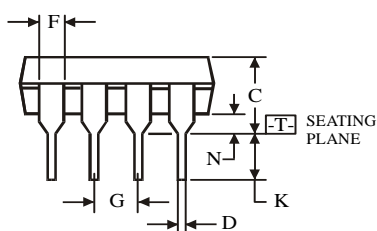
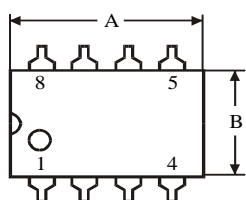
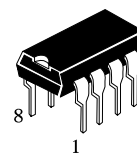

$\oplus 0.25 (0.010) \text{ (M) T}$

Symbol	Dimension, mm	
	MIN	MAX
A	8.51	10.16
B	6.1	7.11
C		5.33
D	0.36	0.56
F	1.14	1.78
G	2.54	
H	7.62	
J	0°	10°
K	2.92	3.81
L	7.62	8.26
M	0.2	0.36
N	0.38	

**NOTES:**

- Dimensions "A", "B" do not include mold flash or protrusions.  
Maximum mold flash or protrusions 0.25 mm (0.010) per side.

**D SUFFIX SOIC  
(MS - 012AA)**

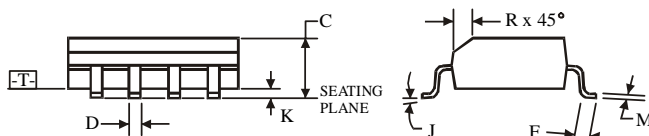
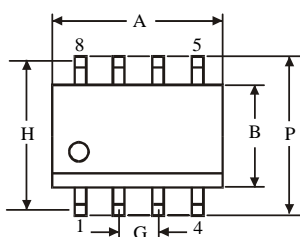
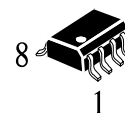

$\oplus 0.25 (0.010) \text{ (M) T C (M)}$

Symbol	Dimension, mm	
	MIN	MAX
A	4.8	5
B	3.8	4
C	1.35	1.75
D	0.33	0.51
F	0.4	1.27
G	1.27	
H	5.72	
J	0°	8°
K	0.1	0.25
M	0.19	0.25
P	5.8	6.2
R	0.25	0.5

**NOTES:**

- Dimensions A and B do not include mold flash or protrusion.
- Maximum mold flash or protrusion 0.15 mm (0.006) per side for A; for B - 0.25 mm (0.010) per side.