

## FEATURES

- **Current Transfer Ratio at  $I_F=10$  mA**  
**IL1, 20% Min.**  
**IL2, 100% Min.**  
**IL5, 50% Min.**
- **High Collector-Emitter Voltage**  
**IL1 –  $BV_{CEO}=50$  V**  
**IL2, IL5 –  $BV_{CEO}=70$  V**
- **Field-Effect Stable by TRansparent IO n Shield (TRIOS)**
- **Double Molded Package Offers Isolation Test Voltage 5300 VAC<sub>RMS</sub>**
- **Underwriters Lab File #E52744**
-  **VDE Approval #0884**  
**(Available with Option 1)**

## DESCRIPTION

The IL1/2/5 are optically coupled isolated pairs employing GaAs infrared LEDs and silicon NPN phototransistor. Signal information, including a DC level, can be transmitted by the drive while maintaining a high degree of electrical isolation between input and output. The IL1/2/5 are especially designed for driving medium-speed logic and can be used to eliminate troublesome ground loop and noise problems. These couplers can be used also to replace relays and transformers in many digital interface applications such as CRT modulation.

See Appnote 45, "How to Use Optocoupler Normalized Curves."

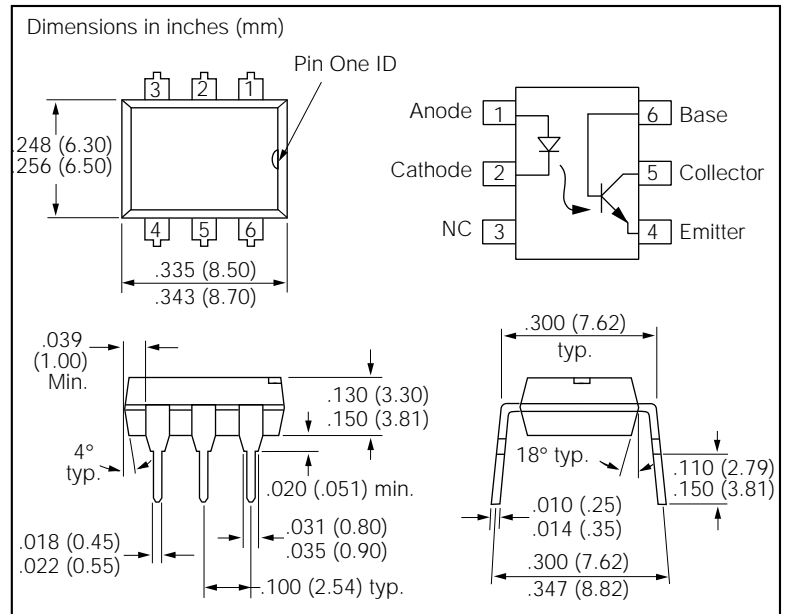

## Maximum Ratings

### Emitter

Reverse Voltage .....	6 V
Forward Current .....	60 mA
Surge Current .....	2.5 A
Power Dissipation .....	100 mW
Derate Linearly from 25°C .....	1.33 mW/°C

### Detector

Collector-Emitter Reverse Voltage	
IL1 .....	50 V
IL2, IL5 .....	70 V
Emitter-Base Reverse Voltage .....	7 V
Collector-Base Reverse Voltage .....	70 V
Collector Current .....	50 mA
Collector Current ( $t < 1$ ms) .....	400 mA
Power Dissipation .....	200 mW
Derate Linearly from 25°C .....	2.6 mW/°C

### Package

Package Power Dissipation .....	250 mW
Derate Linearly from 25°C .....	3.3 mW/°C
Isolation Test Voltage (between emitter and detector referred to standard climate 23°C/50%RH, DIN 50014) 5300 VAC <sub>RMS</sub>	
Creepage .....	min. 7 mm
Clearance .....	min. 7 mm
Comparative Tracking Index per DIN IEC 112/VDE 0303, part 1 .....	175
Isolation Resistance	
$V_{IO}=500$ V, $T_A=25^\circ\text{C}$ .....	$\geq 10^{12} \Omega$
$V_{IO}=500$ V, $T_A=100^\circ\text{C}$ .....	$\geq 10^{11} \Omega$
Storage Temperature .....	-40°C to +150°C
Operating Temperature .....	-40°C to +100°C
Junction Temperature .....	100°C
Soldering Temperature (2 mm from case bottom) .....	260°C

## Characteristics

	Symbol	Min	Typ	Max	Unit	Condition
<b>Emitter</b>						
Forward Voltage	$V_F$		1.25	1.65	V	$I_F=60\text{ mA}$
Breakdown Voltage	$V_{BR}$	6	30		V	$I_R=10\text{ }\mu\text{A}$
Reverse Current	$I_R$		0.01	10	$\mu\text{A}$	$V_R=6\text{ V}$
Capacitance	$C_O$		40		pF	$V_R=0\text{ V}$ , $f=1\text{ MHz}$
Thermal Resistance Junction to Lead	$R_{THJL}$		750		$^{\circ}\text{C/W}$	
Detector						
Capacitance	$C_{CE}$ $C_{CB}$ $C_{EB}$		6.8 8.5 11		pF pF pF	$V_{CE}=5\text{ V}$ , $f=1\text{ MHz}$ $V_{CB}=5\text{ V}$ , $f=1\text{ MHz}$ $V_{EB}=5\text{ V}$ , $f=1\text{ MHz}$
Collector-Emitter Leakage Current	$I_{CEO}$		5	50	nA	$V_{CE}=10\text{ V}$
Collector-Emitter Saturation Voltage	$V_{CESAT}$		0.25			$I_{CE}=1\text{ mA}$ , $I_B=20\text{ }\mu\text{A}$
Base-Emitter Voltage	$V_{BE}$		0.65		V	$V_{CE}=10\text{ V}$ , $I_B=20\text{ }\mu\text{A}$
DC Forward Current Gain	HFE	200	650	1800		$V_{CE}=10\text{ V}$ , $I_B=20\text{ }\mu\text{A}$
Saturated DC Forward Current Gain	$HFE_{SAT}$	120	400	600		$V_{CE}=0.4\text{ V}$ , $I_B=20\text{ }\mu\text{A}$
Thermal Resistance Junction to Lead	$R_{THJL}$		500		$^{\circ}\text{C/W}$	
<b>Package Transfer Characteristics</b>						
<b>IL1</b>						
Saturated Current Transfer Ratio (Collector-Emitter)	$CTR_{CESAT}$		75		%	$I_F=10\text{ mA}$ , $V_{CE}=0.4\text{ V}$
Current Transfer Ratio (Collector-Emitter)	$CTR_{CE}$	20	80	300	%	$I_F=10\text{ mA}$ , $V_{CE}=10\text{ V}$
Current Transfer Ratio (Collector-Base)	$CTR_{CB}$		0.25		%	$I_F=10\text{ mA}$ , $V_{CB}=9.3\text{ V}$
<b>IL2</b>						
Saturated Current Transfer Ratio (Collector-Emitter)	$CTR_{CESAT}$		170		%	$I_F=10\text{ mA}$ , $V_{CE}=0.4\text{ V}$
Current Transfer Ratio (Collector-Emitter)	$CTR_{CE}$	100	200	500	%	$I_F=10\text{ mA}$ , $V_{CE}=10\text{ V}$
Current Transfer Ratio	$CTR_{CB}$		0.25		%	$I_F=10\text{ mA}$ , $V_{CB}=9.3\text{ V}$
<b>IL5</b>						
Saturated Current Transfer Ratio (Collector-Emitter)	$CTR_{CESAT}$		100		%	$I_F=10\text{ mA}$ , $V_{CE}=0.4\text{ V}$
Current Transfer Ratio (Collector-Emitter)	$CTR_{CE}$	50	130	400	%	$I_F=10\text{ mA}$ , $V_{CE}=10\text{ V}$
Current Transfer Ratio	$CTR_{CB}$		0.25		%	$I_F=10\text{ mA}$ , $V_{CB}=9.3\text{ V}$
<b>Isolation and Insulation</b>						
Common Mode Rejection Output High	CMH		5000		V/ $\mu\text{s}$	$V_{CM}=50\text{ V}_{P-P}$ , $R_L=1\text{ k}\Omega$ , $I_F=0\text{ mA}$
Common Mode Rejection Output Low	CML		5000		V/ $\mu\text{s}$	$V_{CM}=50\text{ V}_{P-P}$ , $R_L=1\text{ k}\Omega$ , $I_F=10\text{ mA}$
Common Mode Coupling Capacitance	$C_{CM}$		0.01		pF	
Package Capacitance	$C_{I-O}$		0.6		pF	$V_{I-O}=0\text{ V}$ , $f=1\text{ MHz}$
Insulation Resistance	$R_S$		$10^{+14}$		$\Omega$	$V_{I-O}=500\text{ V}$

## SWITCHING TIMES

**Figure 1. Non-saturated switching timing**

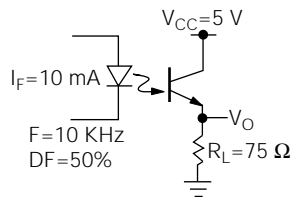

**Figure 2. Saturated switching timing**

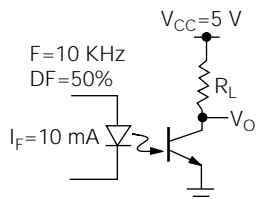

**Figure 3. Non-saturated switching timing**

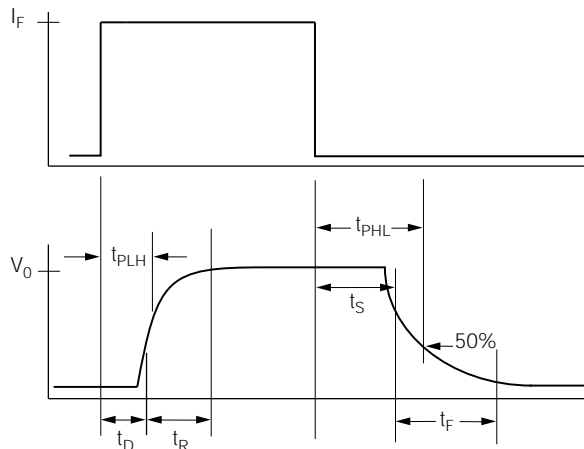

**Figure 4. Saturated switching timing**

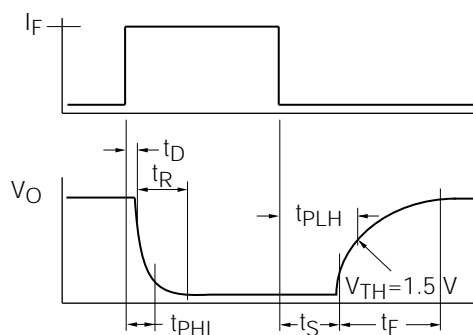

**Non-Saturated Switching Time Table-Typical**

Characteristic	Sym	IL1 I <sub>F</sub> =20 mA	IL2 I <sub>F</sub> =5 mA	IL5 I <sub>F</sub> =10 mA	Unit	Test Condition
Delay	T <sub>D</sub>	0.8	1.7	1.7	μs	
Rise Time	t <sub>R</sub>	1.9	2.6	2.6	μs	V <sub>CC</sub> =5 V
Storage	t <sub>S</sub>	0.2	0.4	0.4	μs	R <sub>L</sub> =75 Ω
Fall Time	t <sub>F</sub>	1.4	2.2	2.2	μs	
Propagation H-L	t <sub>PHL</sub>	0.7	1.2	1.1	μs	t <sub>p</sub> measured at 50% of output
Propagation L-H	t <sub>PLH</sub>	1.4	2.3	2.5	μs	

**Saturated Switching Time Table-Typical**

Characteristic	Sym	IL1 I <sub>F</sub> =20 mA	IL2 I <sub>F</sub> =5 mA	IL5 I <sub>F</sub> =10 mA	Unit	Test Condition
Delay	T <sub>D</sub>	0.8	1	1.7	μs	
Rise Time	t <sub>R</sub>	1.2	2	7	μs	V <sub>CL</sub> =5.0 V
Storage	t <sub>S</sub>	7.4	5.4	4.6	μs	V <sub>CE</sub> =0.4
Fall Time	t <sub>F</sub>	7.6	13.5	20	μs	R <sub>L</sub> =1 K
Propagation H-L	t <sub>PHL</sub>	1.6	5.4	2.6	μs	V <sub>TH</sub> =1.5 V
Propagation L-H	t <sub>PLH</sub>	8.6	7.4	7.2	μs	

Figure 5. Forward voltage versus forward current

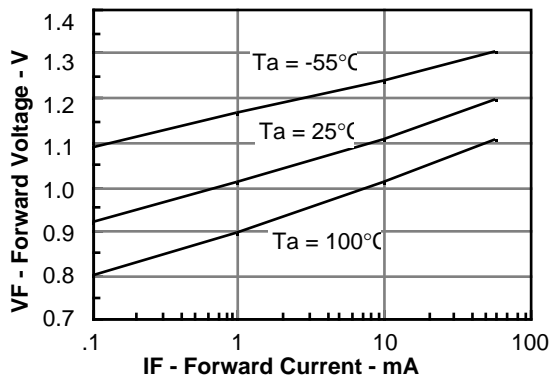

Figure 6. Normalized non-saturated and saturated CTR at  $T_A=25^\circ\text{C}$  versus LED current

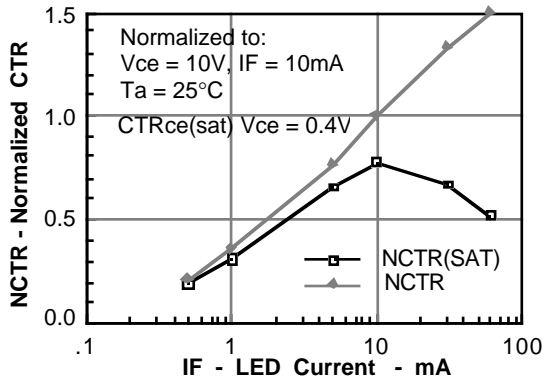

Figure 7. Normalized non-saturated and saturated CTR at  $T_A=50^\circ\text{C}$  versus LED current

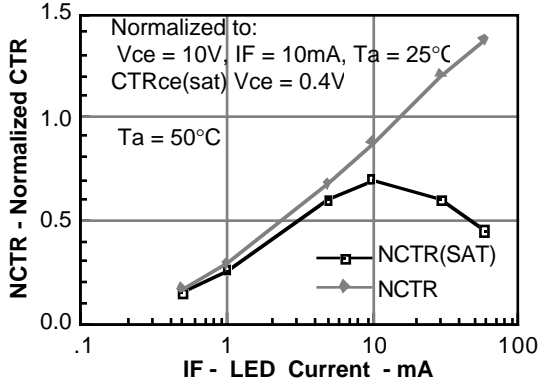

Figure 8. Normalized non-saturated and saturated CTR at  $T_A=70^\circ\text{C}$  versus LED current

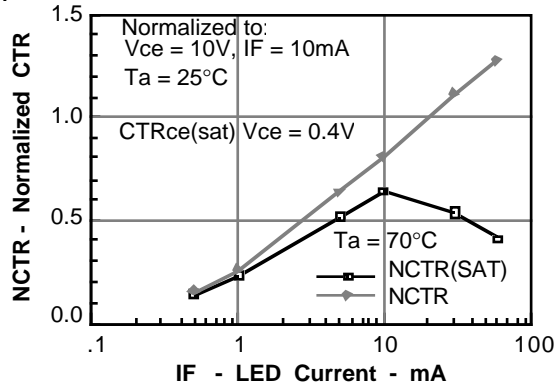

Figure 9. Normalized non-saturated and saturated CTR at  $T_A=100^\circ\text{C}$  versus LED current

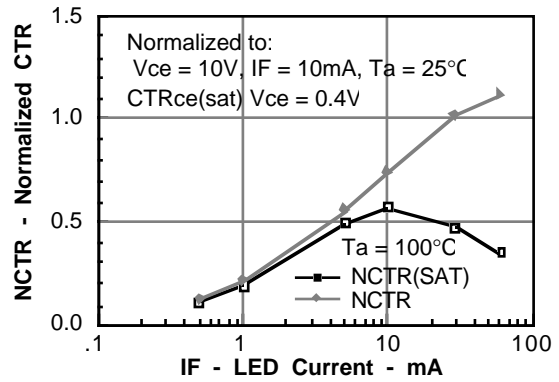

Figure 10. Collector-emitter current versus temperature and LED current

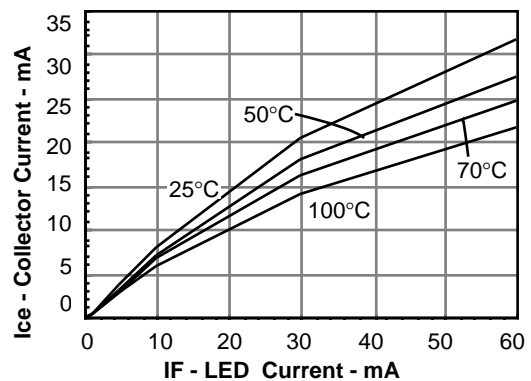

Figure 11. Collector-emitter leakage current versus temperature

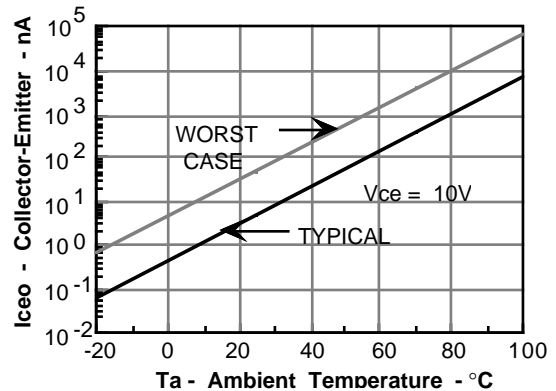

Figure 12. Normalized CTRcb versus LED current and temperature

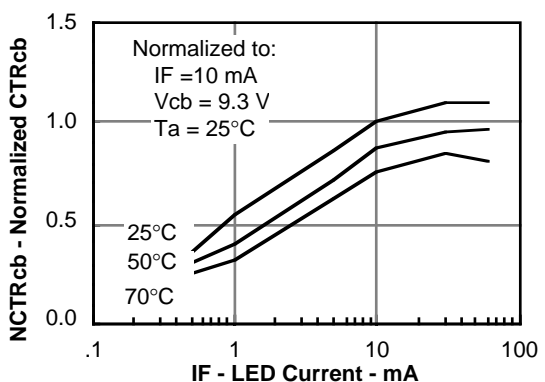

Figure 13. Collector base photocurrent versus LED current

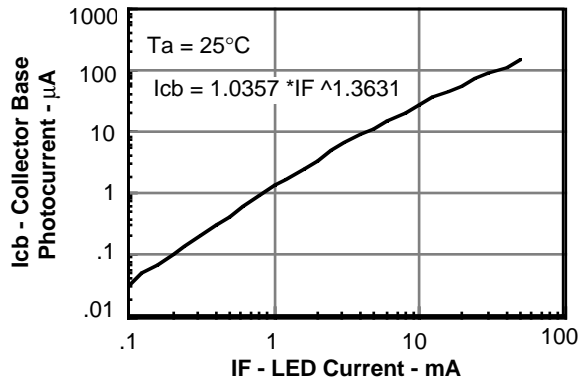

Figure 16. Normalized saturated HFE versus base current and temperature

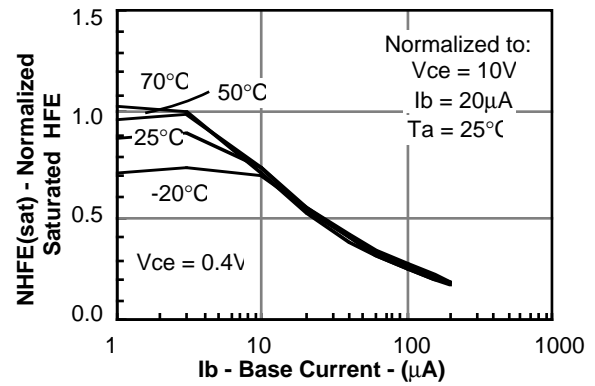

Figure 14. Normalized photocurrent versus  $I_f$  and temperature

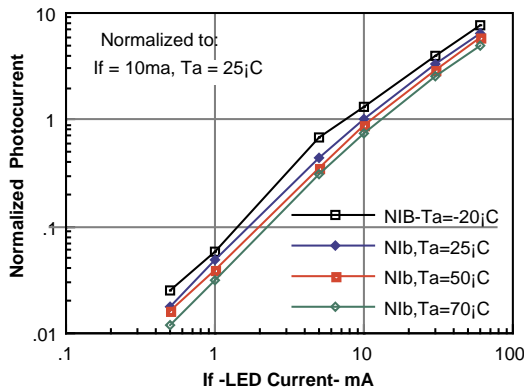

Figure 17. Propagation delay versus collector load resistor

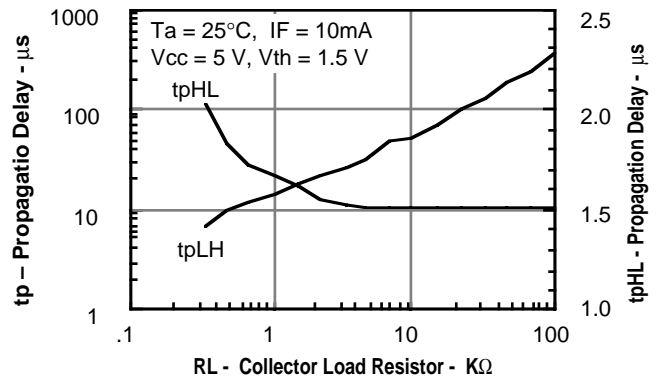

Table 15. Normalized non-saturated HFE versus base current and temperature

