

**IL91260C**

# 10 Memory Tone/Pulse Dialer

## High-Performance Silicon-Gate CMOS

The IL91260C is tone/pulse switchable dialer with ten 16-digit number memories and 32-digit redial memory. Pulse to tone mode switching is performed via a slide switch.

- 32-digit redial memory (31 digits in tone mode)
- Ten indirect memories, 16 digits in pulse mode, 15 digits in tone mode
- Tone/Pulse mode switching via slide switch (4.1 second pause inserted automatically)
- Wide operating voltage: 1.8 V ~ 5.5 V
- Uses 480 KHz ceramic resonator
- Low memory retention current
- Selectable Make/Break ratio
- Dial Pulse Rate: 10 pps

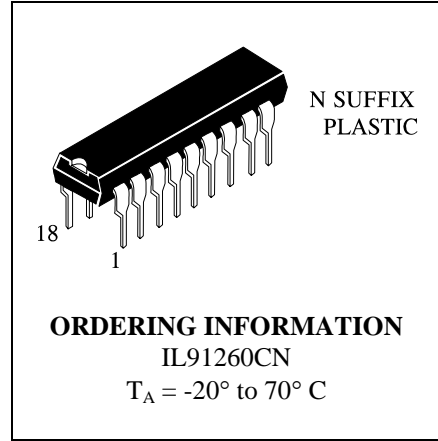

### PIN ASSIGNMENT

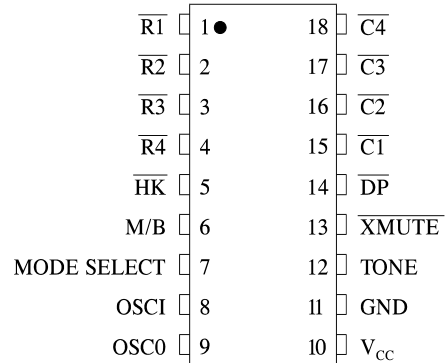

### LOGIC DIAGRAM

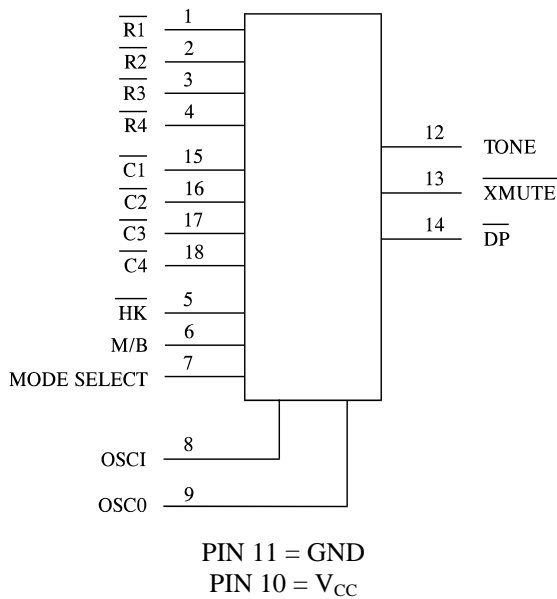

### Keyboard Assignments\*

1	2	3	S	$\overline{R1}$
4	5	6	A/L	$\overline{R2}$
7	8	9	P	$\overline{R3}$
*	0	#	R	$\overline{R4}$
$\overline{C1}$	$\overline{C2}$	$\overline{C3}$	$\overline{C4}$	

- S : Store
- A/L : Auto/Location
- P : Pause
- R : Redial

**Pin Description**

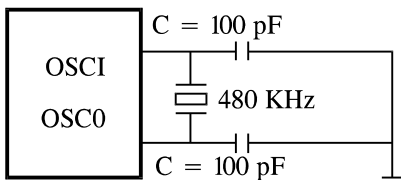
Pin No.	Designation	Description
1	R1	Keyinputs. When a row and a column are connected, a key operation is activated. Scanning signals are present on both the row and column pins during a valid key-in condition.
2	R2	
3	R3	
4	R4	
5	HK	Hook switch input. When HK = V <sub>CC</sub> , an ON-Hook state exists. When HK = GND, an Off-Hook state exists.
6	M/B	Dial pulse Make/Break ratio select input. If M/B = V <sub>CC</sub> , the Make/Break ratio is 1/2. If M/B = GND, the Make/Break ratio is 2/3.
7	MODE SELECT	Pulse/DTMF mode select input. If MODE SELECT = V <sub>CC</sub> , Pulse mode is in effect. If MODE SELECT = GND, DTMF mode is in effect.
8 9	OSCI OSC0	Oscillator I/O. A 480 KHz ceramic resonator and two 100 pF serial loading capacitors form a complete oscillator circuit. The circuit is activated when HK is low. Oscillator start-up time is typically 10 ms. 
10	V <sub>CC</sub>	Positive power supply.
11	GND	Negative power supply.
12	TONE	DTMF signal output. Pull-down load resistance is 10,000 Ω. The minimum tone and IDP durations are built-in for both normal dialing and redialing.
13	XMUTE	Transmit mute output. This is an N-channel open drain output. The output transistor is switched on while a sequence of digits is being dialed (for both Pulse and Tone modes). Otherwise, it is switched off.
14	DP	Dial pulse output. This pin is an N-channel open drain output. When DP output is low (switched on), it serves as a break signal in Pulse dialing. For other operations, DP output is normally high impedance (switched off).
15	C1	Keyinputs. When a row and a column are connected, a key operation is activated. Scanning signals are present on both the row and column pins during a valid key-in condition.
16	C2	
17	C3	
18	C4	

## Operation Procedures

### Symbol Definitions:

- a.  $D_t$  : tone digit, 1, 2, 3, 4, 5, 6, 7, 8, 9, 0, \*, #  
 $D_p$  : Pulse digit, 1, 2, 3, 4, 5, 6, 7, 8, 9, 0
- b.  $LOC_i$  :  $i = 1, 2, 3, 4, 5, 6, 7, 8, 9, 0$
- c.  $ZiZiZi$  : Conversation mode
- d.  $0-0 \uparrow$  : OFF-HOOK
- e.  $0-0 \downarrow$  : ON-HOOK
- f.  $\uparrow$  : Input Level from Low to High
- g.  $\downarrow$  : Input Level from High to Low

### Recommended dialing, redialing, mixed dialing and storing operations:

1. Normal dialing in pulse mode  
 $0-0 \uparrow, D_p \dots D_p, ZiZiZi 0-0 \downarrow$
2. Normal dialing in tone mode  
 $0-0 \uparrow, D_t \dots D_t, ZiZiZi 0-0 \downarrow$
3. Mixed dialing in pulse-to-tone mode  
 $0-0 \uparrow, D_p \dots D_p, MODE SELECT$   
 $\downarrow, D_t \dots D_t, ZiZiZi 0-0 \downarrow$
4. Redialing  
 $0-0 \uparrow, D_p \dots D_p 0-0 \downarrow, 0-0 \uparrow, R, ZiZiZi, 0-0 \downarrow$   
 $0-0 \uparrow, D_t \dots D_t 0-0 \downarrow, 0-0 \uparrow, R, ZiZiZi, 0-0 \downarrow$   
 $\downarrow$   
 Storing Numbers to Repertory Memory  
 (i) Off-hook Store  $0-0 \uparrow, S, D_p \dots D_p$   
 or  $D_t \dots D_t, A/L, LOC_i, 0-0 \downarrow$

5. (ii) On/Off-hook store:  $0-0 \downarrow, S, D_p \dots D_p$  or  $D_t \dots D_t, A/L, LOC_i$
6. Dialing from Repertory Memory  
 $0-0 \uparrow, A/L, LOC_i, ZiZiZi 0-0 \downarrow$

### Functional Description

1. N-Channel Open Drain Output -  $\overline{DP}, \overline{XMUTE}$

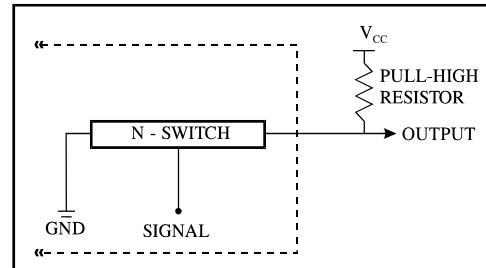

Figure 1.

2. DTMF Generator

The digitally synthesized sinewave of the IN91260 series is well designed, with a 6 level, 12 segment,  $1/2 V_{CC}$  reference voltage. The THD (Total Harmonic Distortion) of the DTMF output is typically 1%, when  $V_{CC} = 2.5 V$  to  $5.5 V$  and frequency is in the 500 HZ to 3400 HZ band.

## MAXIMUM RATINGS\*

Symbol	Parameter	Value	Unit
V <sub>CC</sub>	DC Supply Voltage (Referenced to GND)	-0.3 to +6.0	V
V <sub>IN</sub>	DC Input Voltage (Referenced to GND)	-0.3 to V <sub>CC</sub> +0.3	V
V <sub>OUT</sub>	DC Output Voltage (Referenced to GND)	-0.3 to V <sub>CC</sub> +0.3	V
V <sub>OUT</sub>	DC Output Voltage (DP, XMUTE)	-0.3 to 1.2	V
ITONE	DC Output Current(Tone)	50	mA
P <sub>D</sub>	Power Dissipation in Still Air, Plastic DIP**	500	mW
T <sub>stg</sub>	Storage Temperature	-40 to +125	°C

\* Maximum Ratings are those values beyond which damage to the device may occur.

Functional operation should be restricted to the Recommended Operating Conditions.

\*\* Durlating:  $-10 \text{ mW}/\text{°C}$  from  $65\text{°C}$  to  $70\text{°C}$ .

**RECOMMENDED OPERATING CONDITIONS**

Symbol	Parameter	Min	Max	Unit
V <sub>CC</sub>	DC Supply Voltage (Referenced to GND)	1.8	5.5	V
V <sub>IN</sub>	DC Input Voltage (Referenced to GND)	0	V <sub>CC</sub>	V
V <sub>OUT</sub>	DC Output Voltage (Referenced to GND)	0	V <sub>CC</sub>	V
T <sub>A</sub>	Operating Temperature	-20	+70	°C

This device contains protection circuitry to guard against damage due to high static voltages or electric fields. However, precautions must be taken to avoid applications of any voltage higher than maximum rated voltages to this high-impedance circuit. For proper operation, V<sub>IN</sub> and V<sub>OUT</sub> should be constrained to the range GND ≤ (V<sub>IN</sub> or V<sub>OUT</sub>) ≤ V<sub>CC</sub>.

Unused inputs must always be tied to an appropriate logic voltage level (e.g., either GND or V<sub>CC</sub>). Unused outputs must be left open.

**DC ELECTRICAL CHARACTERISTICS** (Voltages Referenced to GND, V<sub>CC</sub> = 1.8 V to 5.5 V, T<sub>A</sub> = -20 to +70°C)

Symbol	Parameter	Test Conditions	Guaranteed Limits		Unit
			Min	Max	
V <sub>IH</sub>	High-Level Input Voltage		0.8V <sub>CC</sub>	V <sub>CC</sub>	V
V <sub>IL</sub>	Low-Level Input Voltage		0	0.2V <sub>CC</sub>	V
V <sub>MR</sub>	Minimum Memory Retention Voltage	V <sub>CC</sub> = 1.0 V	1.5		V
V <sub>OC</sub> *	Single Column Tone Output Amplitude	R <sub>LOAD</sub> = 10 KΩ V <sub>CC</sub> = 2.5 V	540	640	mVp-p
		R <sub>LOAD</sub> = 10 KΩ V <sub>CC</sub> = 5.5 V	100	1300	
V <sub>OR</sub> *	Single Row Tone Output Amplitude	R <sub>LOAD</sub> = 10 KΩ V <sub>CC</sub> = 2.5 V	410	490	mVp-p
		R <sub>LOAD</sub> = 10 KΩ V <sub>CC</sub> = 5.5 V	850	990	
I <sub>C</sub> *	Column Input Current	V <sub>IN</sub> = 3.5 V All outputs unloaded	0.6	2.0	mA
I <sub>R</sub> *	Row Input Current	V <sub>IN</sub> = 0 V All outputs unloaded	5	50	μA
I <sub>OL1</sub>	Minimum Sink Output Current DP, XMUTE	V <sub>CC</sub> = 3.5 V, V <sub>OL</sub> = 0.4 V	0.7		mA
I <sub>OL2</sub>		V <sub>CC</sub> = 2.0 V, V <sub>OL</sub> = 0.4 V	0.2		mA
I <sub>MR</sub>	Maximum Memory Retention Current	V <sub>CC</sub> = 1.0 V, HK = V <sub>CC</sub> All outputs unloaded		0.6	μA
I <sub>CCP</sub>	Maximum Supply Operation Current	V <sub>CC</sub> = 3.5 V	Oscillator running; all outputs unloaded, V <sub>IL</sub> = 0, V <sub>IH</sub> = V <sub>CC</sub>	0.7	mA
		V <sub>CC</sub> = 5.5 V		2.1	
I <sub>CCT</sub>		V <sub>CC</sub> = 3.5 V		1.3	mA
		V <sub>CC</sub> = 5.5 V		3.9	
I <sub>SD</sub>	Maximum Standby Current	V <sub>CC</sub> = 2.5 V, HK = GND All outputs unloaded		7.0	μA
T <sub>WIST</sub>	Pre.-emphasis	V <sub>CC</sub> = 3.5 V	1	3	dB
V <sub>V</sub>	Valley of Single Tone	V <sub>CC</sub> = 3.5 V	0.3	6.0	V <sub>DD</sub>
DIS%	Distortion	*Note 1, V <sub>CC</sub> = 3.5 V		6.0	%

\* @ 25 °C

Note 1:

$$DIS\% = \frac{100 \cdot (V_1^2 + V_2^2 + \dots + V_n^2)^{1/2}}{(V_{OC}^2 + V_{OR}^2)^{1/2}}$$

- a.  $V_1 \dots V_n$  are the intermodulation or the harmonic frequencies in the 500 Hz to 3400 Hz band.
- b.  $V_{OC}$  and  $V_{OR}$  are the individual frequency components of the DTMF signal.

**AC ELECTRICAL CHARACTERISTICS**(All Voltages referenced to GND.  $V_{CC} = 1.8\text{ V to }5.5\text{ V}$ ,  $T_A = -20$  to  $+70^\circ\text{C}$ ,  $F_{OSK} = 480\text{ KHz}$ )

Symbol	Parameter	Test Conditions	Guaranteed Limits		Unit
			Min	Max	
<b>PULSE</b>					
T <sub>M</sub>	Make Time (Figure 2)	M/B = 1/2	30	35	ms
		M/B = 2/3	38	42	
T <sub>B</sub>	Break Time (Figure 2)	M/B = 1/2	64	69	ms
		M/B = 2/3	57	63	
T <sub>IDP</sub>	Inter Digit Pause Time (Figure 2)	M/B = 1/2	790	815	ms
		M/B = 2/3	790	815	
T <sub>PDP</sub>	Pre-Digit Pause (Figure 2)	M/B = 1/2	820	860	ms
		M/B = 2/3	820	860	
T <sub>MDP</sub>	<u>XMUTE</u> , Delay Time (Figure 2)	M/B = 1/2	0	3	ms
		M/B = 2/3	0	3	
<b>TONE</b>					
T <sub>MFD</sub>	Minimum Tone Duration (Figure 3)		100	120	ms
T <sub>TIDP</sub>	<u>Minimum</u> Tone Inter-Digit Pause ( <u>XMUTE</u> ) (Figure 3)		100	120	ms
T <sub>TPDP</sub>	Tone Output Pre-Digit Pause (Figure 3)		115	145	ms
T <sub>MDT</sub>	<u>XMUTE</u> Delay Time (Figure 3)		100	120	ms
T <sub>AP</sub>	Auto Pause Time (Figure 4)		3.9	4.3	s
T <sub>START</sub>	Oscillator Start-up Time (Figure 2)		4	13	ms
T <sub>MS</sub>	<u>XMUTE</u> Start-up Time (Figure 2)		25	35	ms
<b>KEY-IN</b>					
T <sub>KD</sub>	Keypad Debounce Time (Figure 2)		19	25	ms
F <sub>KS</sub>	Key Scan Frequency	C1 ~ C4, R1~ R4	365	390	Hz

**Comparisons of Specified vs. Actual Tone Frequencies**

R/C	Spec.	Actual	Error(%)	Unit	Conditions
R1	697	695.65	-0.19	Hz	F <sub>OSC</sub> =480 KHz
R2	770	769.23	-0.1	Hz	
R3	852	851.06	-0.11	Hz	
R4	941	941.18	+0.02	Hz	
C1	1,209	1,212.12	+0.26	Hz	
C2	1,336	1,333.33	-0.2	Hz	
C3	1,477	1,481.48	+0.3	Hz	

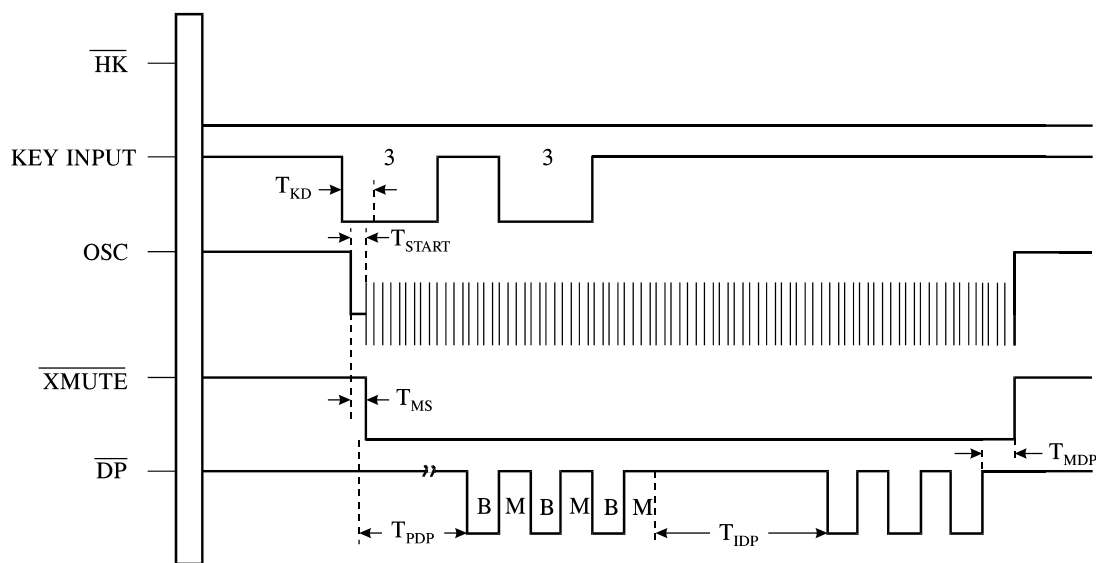

**Figure 2. Pulse Mode**

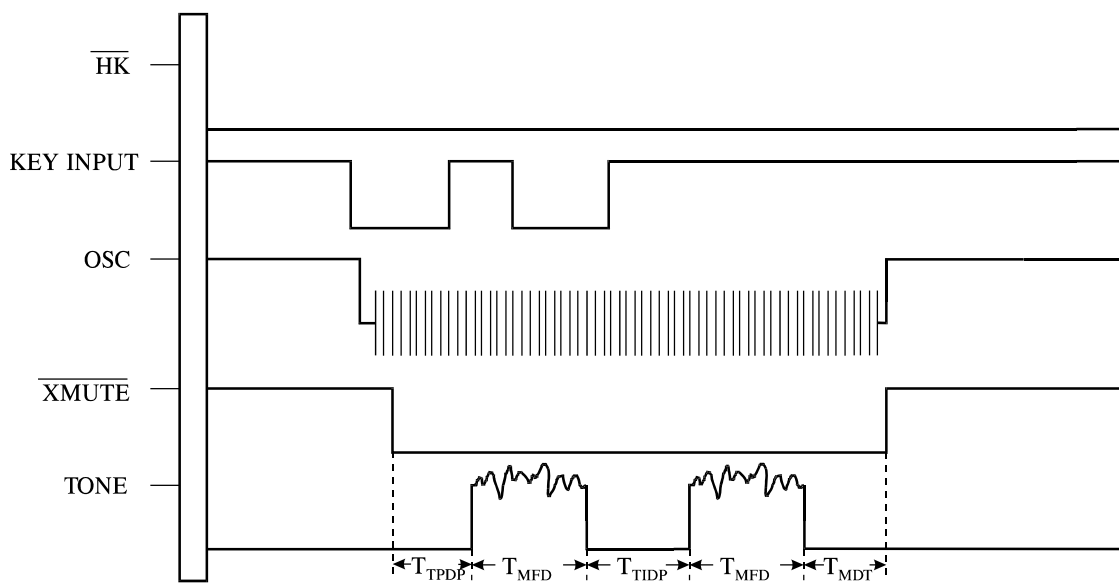

**Figure 3. Tone Mode**

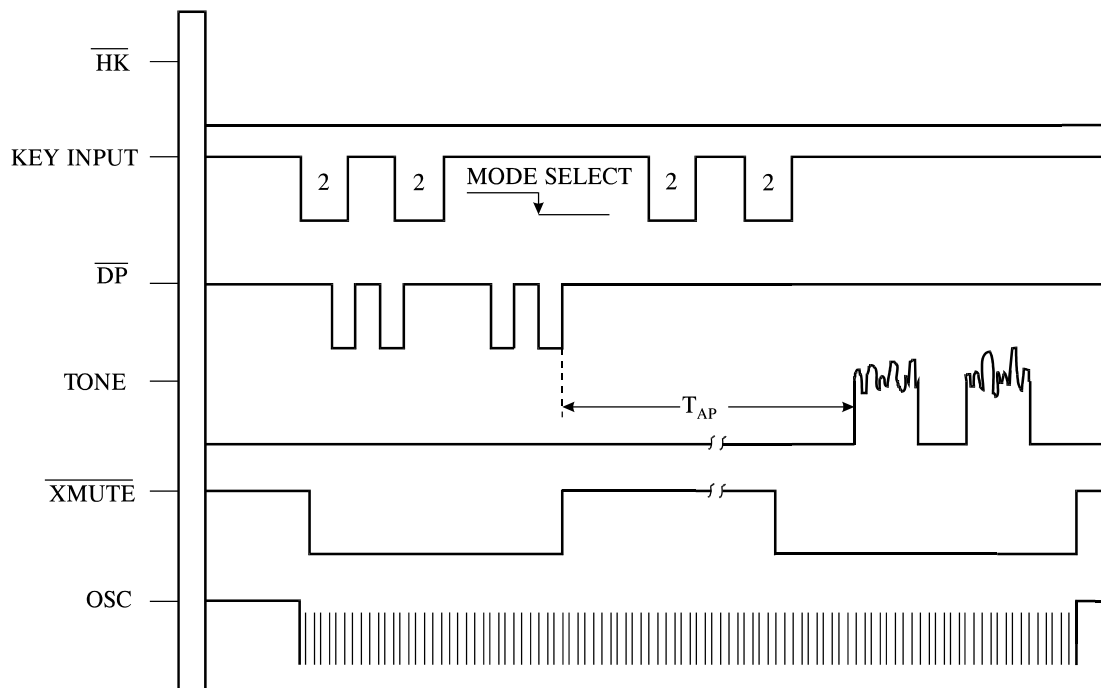
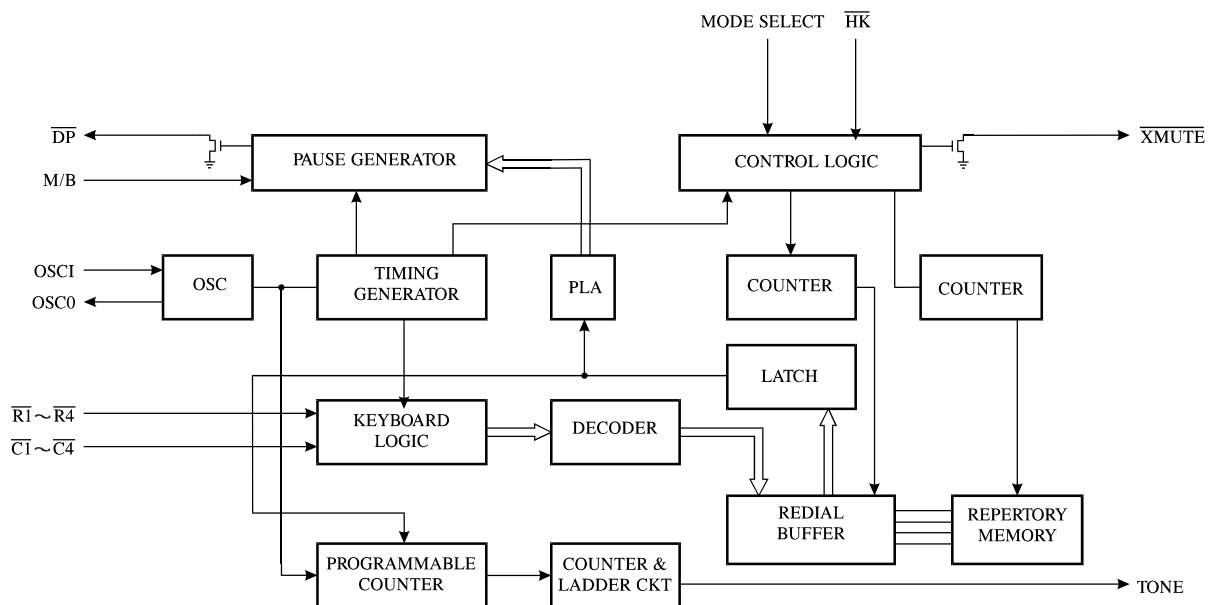
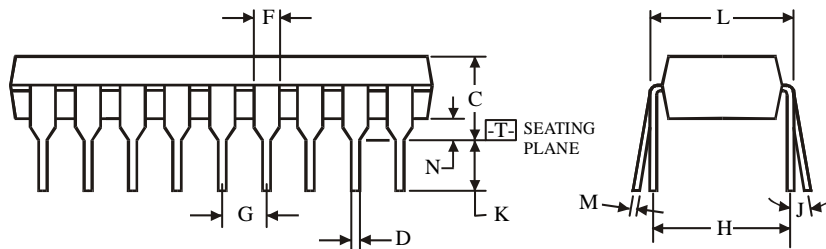
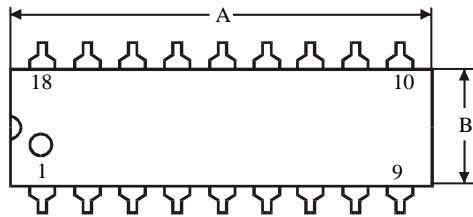
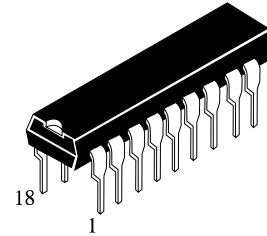

Figure 4. Normal Pulse to Tone mixed dialing via slide switch

### EXPANDED LOGIC DIAGRAM



N SUFFIX PLASTIC DIP  
(MS - 001AC)



$\oplus 0.25 (0.010) \text{M} \text{T}$

NOTES:

- Dimensions "A", "B" do not include mold flash or protrusions.  
Maximum mold flash or protrusions 0.25 mm (0.010) per side.

Symbol	Dimension, mm	
	MIN	MAX
A	22.35	23.37
B	6.1	7.11
C		5.33
D	0.36	0.56
F	1.14	1.78
G	2.54	
H	7.62	
J	0°	10°
K	2.92	3.81
L	7.62	8.26
M	0.2	0.36
N	0.38	