

ILC6376/77

0.5A, 300kHz, SO-8 PWM/PFM Step Down Converter with Shutdown

Features

- $\pm 2.5\%$ accurate output voltages
- Guaranteed 500mA output current
- 95% efficiency
- 55 μ A no load battery input current (ILC6377)
- 1.5 μ A shutdown current
- Built in short circuit and overcurrent protection
- Undervoltage lockout and soft-start
- External transistor drive available for higher I_{OUT}
- 300kHz operation
- Automatic switchover to PFM mode at low currents for longest battery life (ILC6377)
- Fixed 3.3V or 5V or adjustable output
- SO-8 package

Applications

- Cellular Phones
- Palmtops and PDAs
- Portable Instrumentation
- Buck Converter for Industrial / Networking Applications

Description

The ILC6376/77 is a 95% efficient, 300kHz step-down DC-DC converter in an SO-8 package; capable of delivering 500mA output current. The device is also capable of driving an external FET for higher output current applications.

The ILC6376/77 uses a unique p-channel architecture with built-in charge pump to maintain low on-resistance, even at low input voltages. The ILC6376 operates in PWM mode with 300kHz switching frequency. The ILC6377 does the same at high and medium load currents. When the load current drops and the device hits approximately 25% duty cycle, ILC6377 automatically switches over to PFM or pulse skipping mode. PFM (pulse frequency modulation) mode of operation extends efficiency at light loads.

Start-up is controlled via an external soft-start capacitor. The device will automatically re-enter start-up mode when an output current overload condition is sensed; thus providing automatic short-circuit protection. Voltage lockout prevents faulty operation below the minimum operating voltage level. In shutdown, the ILC6376/77 consumes only 1.5 μ A current.

The ILC6376/77SOXX offers fixed 3.3V or 5V output while ILC6376/77SOADJ allows adjustable output. Both versions of ILC6376/77 are available in an SO-8 surface mount package.

Typical Applications

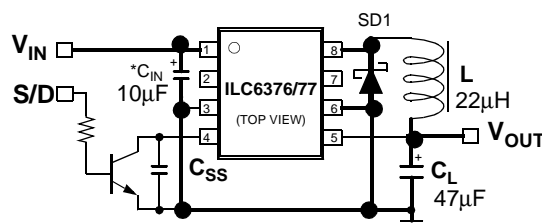
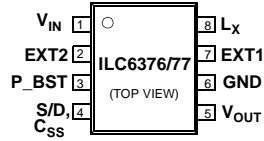

Fig 1. Typical step-down DC-DC converter application

- SD1: SS12 Schottky Diode (FAIRCHILD)
- C_L : 10V/47 μ F Tantalum Capacitor (NICHICON, F93)
- C_{SS} : 4700pF Ceramic Capacitor
- C_{IN} : 16V / 10 μ F Tantalum Capacitor (NICHICON, F93)

Pin Assignments



ILC6376/77 SOXX
SO-8 Package

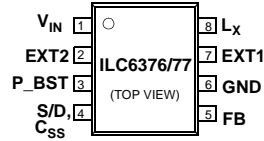

ILC6376/77 SOADJ
SO-8 Package

Pin Definitions

Pin	Symbol	Function
1	V_{IN}	Power Supply
2	EXT2	External gate drive pin (low when P-Ch FET is ON)
3	P-BST	P-Ch gate boost
4	S/D, Softstart, V_{REF}	Shutdown, also soft-start capacitor pin and V_{REF} output
5	V_{OUT} / FB	Output voltage sense pin for ILC6376/77SO-XX; 1V feedback pin for ILC6376/77SO-ADJ
6	GND	Ground connection
7	EXT1	External gate drive pin (low when P-Ch FET is ON)
8	L_X	Inductor Switch Pin

Internal Block Diagram

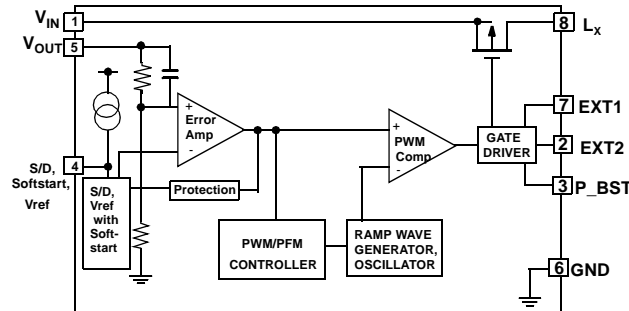

Absolute Maximum Ratings ($T_A=25^\circ\text{C}$)

Parameter	Symbol	Ratings	Units
V_{IN} Input Voltage Pin	V_{IN}	-0.3 to +12	V
V_{OUT} Pin (ILC6376/77SOXX) FB Pin (ILC6376/77SOADJ)	V_{OUT} V_{FB}	-0.3 to +12 -0.3 to $V_{IN} + 0.3$	V
Voltage on L_X pin	V_{LX}	$V_{IN} - V_{LX} = -0.3$ to +12	V
Peak Switch Current on L_X pin	I_{LX}	700	mA
Voltage on P_BST pin	V_{DP_BST}	$V_{IN} - V_{P_BST} = -0.3$ to +12	V
Current EXT1, EXT2 pins	I_{EXT1}, I_{EXT2}	± 50	mA
Voltage on all other pins	~	-0.3 to $V_{IN} + 0.3$	V
Continuous Total Power Dissipation	P_D	300	mW
Operating Ambient Temperature	T_{OPR}	-30~+80	$^\circ\text{C}$
Storage Temperature	T_{STG}	-40~+125	$^\circ\text{C}$

Electrical Characteristics ILC6376/77SO33

$V_{OUT} = 3.3\text{V}$, $V_{IN} = 4\text{V}$, $F_{OSC} = 300\text{kHz}$, $I_{OUT} = 130\text{mA}$, $T_A = 25^\circ\text{C}$, unless otherwise specified. Circuit configuration figure 1.

Parameter	Symbol	Conditions	Min.	Typ.	Max.	Units
Output Voltage	V_{OUT}		3.218	3.300	3.383	V
Input Voltage	V_{IN}				10	V
Output Maximum Current	$I_{OUT(MAX)}$		500	600		mA
Input Current Supply	I_{IN}	$V_{IN} 3.5\text{V}$, No Loads	ILC6376	1480	2190	μA
			ILC6377	50	86	
Shutdown Current	$I_{S/D}$	$V_{S/D} = 0\text{V}$		1.5	2.5	μA
L_X Switch On - Resistance	$R_{ds(on)}$	Open Loop Measurement, $V_{S/D} = V_{IN}$, $V_{LX} = V_{IN} - 0.2\text{V}$, $V_{OUT} = 3\text{V}$		0.64	0.85	Ω
L_X Switch Leakage Current	I_{LXL}	Open Loop Measurement, $V_{OUT} = V_{IN}$, $V_{LX} = 0\text{V}$			2.0	μA
Oscillator Frequency	F_{OSC}	Measurement Waveform at EXT pin $V_{IN} = 3.6\text{V}$ $I_{OUT} = 20\text{mA}$	255	300	345	kHz
Max Duty Cycle	MAXDTY			100		%
PFM Duty Cycle	PFMDTY	No Load (ILC6377)	15	25	35	%
Efficiency	EFFI			95		%
Undervoltage Lockout	V_{UVLO}	Minimum V_{IN} when V_{ref} does not start up	0.9		1.8	V
Soft-Start Time	T_{SS}	V_{REF} rises to 0V from 0.9V	6.0	10.0	16.0	msec
Shutdown Input Voltage	V_{SD}	High = Regulator "ON" Low = Regulator "OFF"	0.65		0.2	V
EXT1, EXT2 Hi On-Resistance	REX_{tHI}	3V applied to V_{OUT} with no external components		35	47	Ω
EXT1, EXT2 Low On-Resistance	REX_{tLOW}	3.6V applied to V_{OUT} with no external components		29	37	Ω

Electrical Characteristics ILC6376/77SO50

Unless Otherwise specified all limits are at $V_{OUT} = 5.0V$, $V_{IN} = 6V$, $F_{OSC} = 300kHz$, $I_{OUT} = 200mA$, $T_A = 25^\circ C$. Circuit configuration figure 1.

Parameter	Symbol	Conditions	Min.	Typ.	Max.	Units
Output Voltage	V_{OUT}		4.875	5.000	5.125	V
Input Voltage	V_{IN}				10	V
Output Maximum Current	$I_{OUT(MAX)}$		500	600		mA
Input Supply Current	I_{IN}	$V_{IN} = 5.25V$, No Load	ILC6376	2540	3740	μA
			ILC6377	71	110	
Shutdown Current	$I_{S/D}$	$V_{S/D} = 0V$		1.5	2.5	μA
L_X Switch On-Resistance	$R_{ds(on)}$	Open Loop Measurement, $V_{S/D} = V_{IN}$, $V_{LX} = V_{IN} - 0.2V$, $V_{OUT} = 4.5V$		0.44	0.58	Ω
L_X Switch Leakage Current	I_{LXL}	Open Loop Measurement, $V_{OUT} = V_{IN}$, $V_{LX} = 0V$			2.0	μA
Oscillator Frequency	F_{OSC}	Measure Waveform at EXT pin $V_{IN} = 5.3V$ $I_{OUT} = 20mA$	255	300	345	kHz
Max Duty Cycle	MAXDTY			100		%
PFM Duty Cycle	PFMDTY	No Load (ILC6377)	15	25	35	%
Efficiency	EFFI			95		%
Undervoltage Lockout	V_{UVLO}	Minimum V_{IN} when V_{REF} does not start up	0.9		1.8	V
Soft-Start Time	T_{SS}	V_{REF} rises to 0V from 0.9V	6.0	10.0	16	msec
Shutdown Input Voltage	$V_{S/D}$	High = Regulator "ON" Low = Regulator "OFF"	0.65		0.2	V
EXT1, EXT2 Hi On-Resistance	REX_{tHI}	Open Loop Measurement		24	32	Ω
EXT1, EXT2 Low On-Resistance	REX_{tLOW}	Open Loop Measurement		20	26	Ω

Electrical Characteristics ILC6376/77SOADJ

Unless Otherwise specified all limits are at V_{OUT} programmed to 5.0V, $V_{IN} = 6V$, $F_{OSC} = 300kHz$, $I_{OUT} = 200mA$, $T_A = 25^\circ C$.
Circuit configuration figure 1.

Parameter	Symbol	Conditions	Min.	Typ.	Max.	Units
Feedback Voltage (pin 5)	V_{FB}		.995	1.000	1.015	V
Output Voltage	V_{OUT}	$R_{FB1} + R_{FB2} \leq 2M\Omega$	1.5		6	V
Output Maximum Current	$I_{OUT(MAX)}$		500	600		mA
Input Supply Current	I_{IN}	$V_{IN} = 5.25V$, No Load		71	110	μA
Shutdown Current	$I_{S/D}$	$V_{S/D} = 0V$		1.5	2.5	μA
L_X Switch On-Resistance	$R_{ds(on)}$	Open Loop Measurement, $V_{S/D} = V_{IN}$, $V_{LX} = V_{IN} - 0.2V$, $V_{OUT} = 4.5V$		0.44	0.58	Ω
L_X Leak Current	I_{LXL}	Open Loop Measurement, $V_{OUT} = V_{IN}$, $V_{LX} = 0V$			2.0	μA
Oscillator Frequency	F_{OSC}	Measure Waveform at EXT pin $V_{IN} = 5.3V$ $I_{OUT} = 20mA$	255	300	345	kHz
Max Duty Cycle	MAXDTY			100		%
PFM Duty Cycle	PFMDTY	No Load (ILC6377)	15	25	35	%
Efficiency	EFFI			95		%
Undervoltage Lockout	V_{UVLO}	Minimum V_{IN} when V_{REF} does not start up	0.9		1.8	V
Soft-Start Time	T_{SS}	V_{REF} rises to 0V from 0.9V	6.0	10.0	16.0	msec
Shutdown Input Voltage	$V_{S/D}$	High = Regulator "ON" Low = Regulator "OFF"	0.65		0.2	V
EXT1, EXT2 Hi On-Resistance	$REXt_{HI}$	Open Loop Measurement		24	32	Ω
EXT1, EXT2 Low On-Resistance	$REXt_{LOW}$	Open Loop Measurement		20	26	Ω

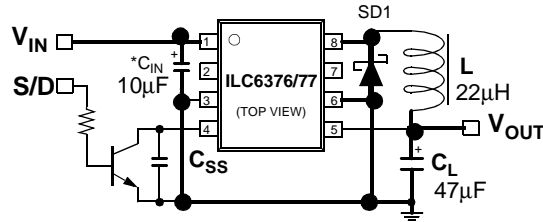

Fig 1. Typical step-down DC-DC converter application

SD1: SS12 Schottky Diode (FAIRCHILD)
 C_L : 10V/47µF Tantalum Capacitor (NICHICON, F93)
 C_{SS} : 4700pF Ceramic Capacitor
 C_{IN} : 16V / 10µF Tantalum Capacitor (NICHICON, F93)

Figure 1 shows a typical fixed output voltage step-down DC-DC converter application circuit for ILC6376/77SOXX.

External component selection

Proper selection of external components is important for achieving high performance. The output inductor selected should have low DC resistance on the order of 0.2Ω or less and saturation current rating of 1A or higher. Recommended inductors are Sumida CD54 (22µH, 0.18Ω max DC resistance) or Coilcraft DO3308P-223 (22µH, 0.18Ω max DC resistance) or equivalent.

The catch diode should be a schottky diode with low forward drop and rated at 1A or greater current, SS12 or it's equivalent is recommended.

Input and output capacitors should be tantalum capacitors with low equivalent series resistance (ESR) and voltage rating higher than the actual application.

Soft-start

Pin 4 of ILC6376/77 functions as the soft-start pin as well as the shutdown pin. A soft-start capacitor (from pin 4 to ground) controls the rate at which the power supply starts up; thus preventing large overshoots at the output as well as large in-rush current. The value for C_{SS} should be 100pF or greater.

Shutdown

The ILC6376/77 is placed in shutdown mode by taking pin 4 to ground. In shutdown, the quiescent current of the device is under 2µA. When using the shutdown feature, pin 4 must be driven from an open collector or open drain output without employing an external pull-up resistor, as shown in figure 2.

Over-current and short-circuit protection

In the event of an over-current or short-circuit condition, the ILC6376/77 cycles the soft-start pin in a hiccup mode to provide fault protection. When the output voltage decreases due to overload, the ILC6376/77 will operate continuously at the maximum duty cycle. If the period of maximum duty cycle operation exceeds T_{PRO} (typically 5 msec), pin 4 will be pulled low; thus discharging the external soft-start capacitor C_{SS} . This action inhibits the regulator's PWM action. Next, the ILC6376/77's soft-start circuitry starts recharging C_{SS} and initiates a controlled start-up. If the overload condition continues to exist, the above sequence of events will repeat; thus continuing to cycle the soft-start function.

Note that very little power is dissipated with this method of fault protection versus constant current limit protection. Even though the internal power MOSFET is pulsed on and off at high peak current, the DC current is low; thus leading to low power dissipation even under short-circuit conditions.

Keep in mind that the duration of maximum duty cycle condition is used to trigger the ILC6376/77's fault protection circuit. As such, a small input-output ($V_{IN} - V_{OUT}$) differential voltage may trigger the device's fault protection circuitry even at low output current.

Undervoltage Lockout

The undervoltage lockout feature prevents faulty operation by disabling the operation of the regulator when input voltage is below the minimum operating voltage, V_{UVLO} . When the input voltage is lower than V_{UVLO} the device disables the internal P-channel MOSFET and provides "high" output at both EXT1 and EXT2 outputs.

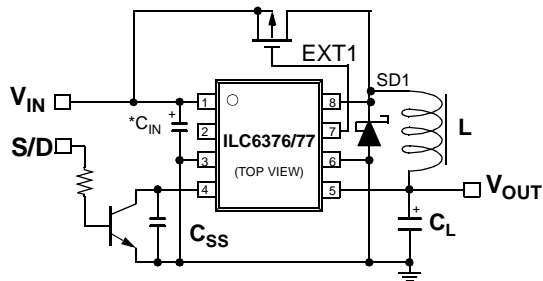

Fig.2 1Amp output current application using external MOSFET

The EXT1 and EXT2 pins are provided so as to drive external transistors; thus allowing design flexibility. The EXT1 output drive signal has the same timing as the gate drive to the internal P-channel MOSFET i.e. EXT1 output is low as long as the internal MOSFET is on. Both EXT1 and EXT2 pins are capable of driving 1000pF gate capacitance. For example, a high output current application circuit using an external P-channel MOSFET is shown in figure 2.

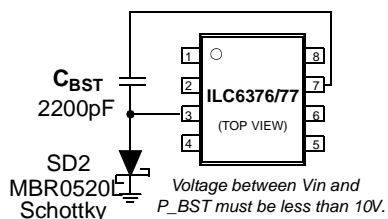

Figure 3. P-Channel Negative Boost Circuit

P-Channel Boost Circuit

The ILC6376/77 includes a unique P-Channel MOSFET architecture with built-in charge pump to maintain low on-resistance even at low input voltages. As shown in figure 3, a 2200pF ceramic capacitor and a schottky diode (MBR0520L or equivalent) allows the gate voltage of the internal P-Channel MOSFET to be driven negative; thus reducing the switch on-resistance. This technique can be employed to increase efficiency at low input voltages and high output currents.

Note that the voltage between V_{IN} and P_BST should not exceed 10V, otherwise damage to the device may occur. For high input voltage applications the schottky diode should be replaced by a low voltage zener diode so that the P_BST pin is clamped to a safe negative voltage.

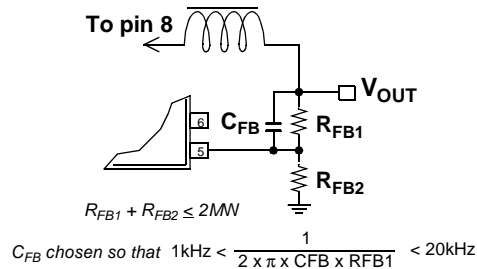

Fig.4 Adjustable output using ILC6376/77SOAD

(Note: rest of circuit is same as Fig.1)

Adjustable Output (ILC6376/77SOADJ)

For adjustable output voltage ILC6376/77SOADJ should be used. All connections to the ILC6376/77SOADJ are the same as ILC6376/77SOXX, except for the feedback voltage divider network shown in figure 4. The output voltage, V_{OUT} , can be calculated from the following equation:

$$V_{OUT} = V_{FB} (1 + R_{FB1}/R_{FB2}), \text{ where } V_{FB} \text{ is approximately } 1V \text{ and } R_{FB1} + R_{FB2} < 2M\Omega$$

The feedback compensation capacitor should be chosen such that the pole frequency f is between 1kHz and 20kHz:

$$1\text{kHz} < \frac{1}{2 \times \pi \times C_{FB} \times R_{FB1}} < 20\text{kHz}$$

The pole frequency should generally be set at 5kHz. The value of C_{FB} calculated from the above equation may require some adjustment depending on the output inductor (L) and output capacitor (C_L) values chosen.

Example for 3V output:

$$\begin{aligned} R_{FB1} &= 400k\Omega \\ R_{FB2} &= 200k\Omega \\ C_{FB} &= 100pF \end{aligned}$$

PC Board Layout

As with all switching DC-DC converter designs, good PC board layout is critical for optimum performance. **The heavy lines indicated in figure 1 schematic should be wide printed circuit board traces and should be kept as short as is practical.** A large ground plane with as much copper area as is allowable should be used. All external components should be mounted as close to the IC as possible. For ILC6376/77SOADJ, the feedback resistors and their associated wiring should be kept away from the inductor location and the vicinity of inductive flux.

Typical Performance Characteristics

General conditions for all curves: Circuit 1; L = 22μH (Sumida, CD54), C_{IN} = 47μF (tantalum) with 0.1μF (ceramic), C_L = 47μH (tantalum) SS12 schottky diode, C_{SS} = 4700pF (ceramic), T_A = 25°C unless otherwise noted.

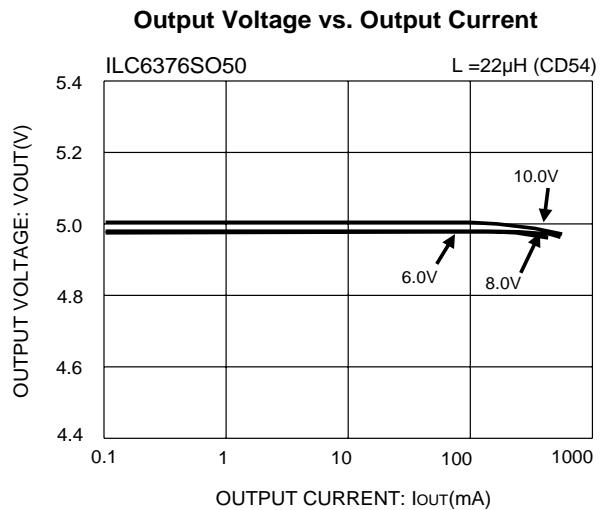
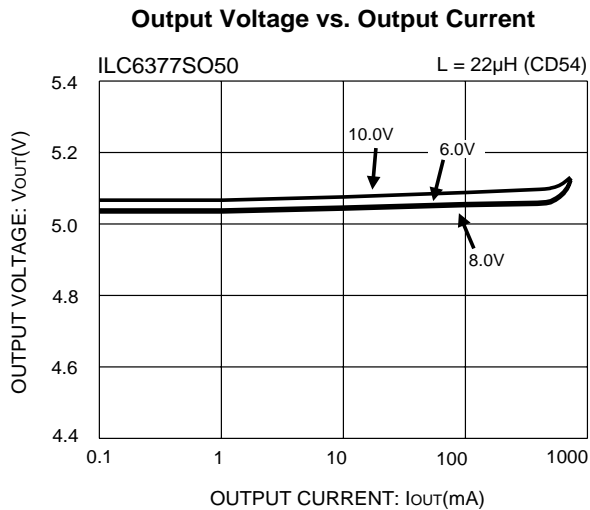
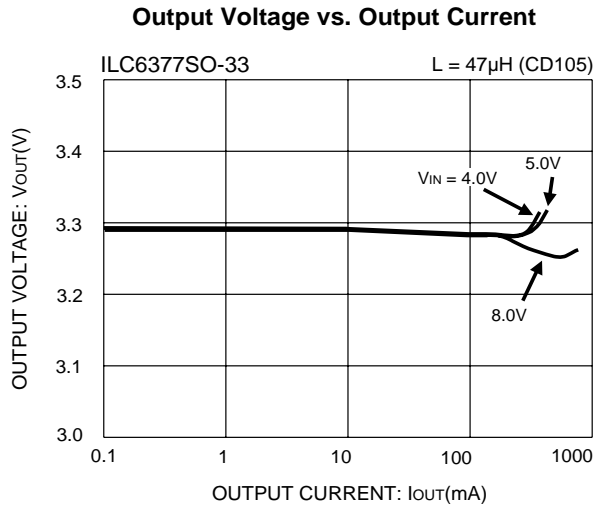
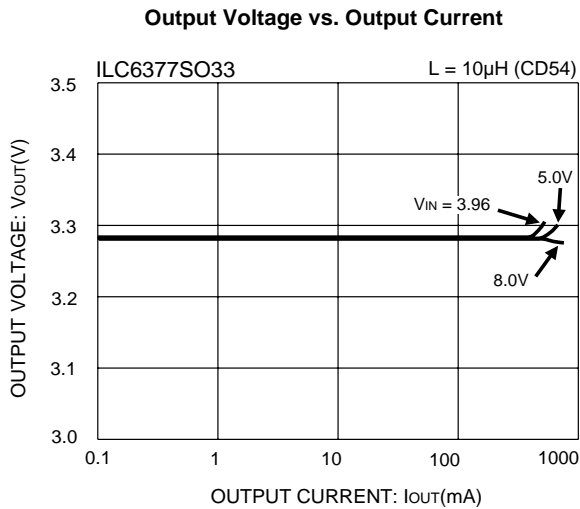
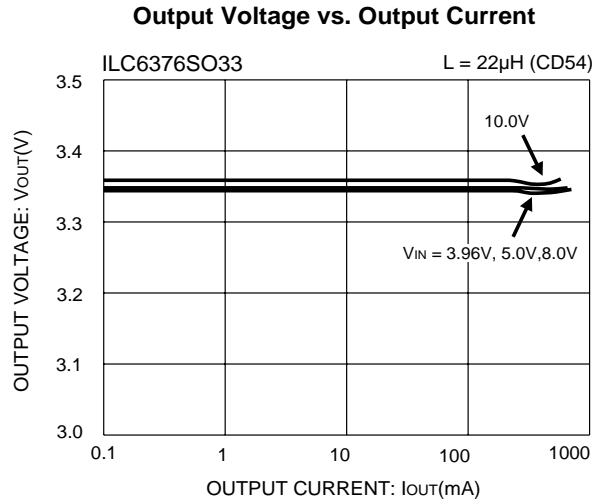
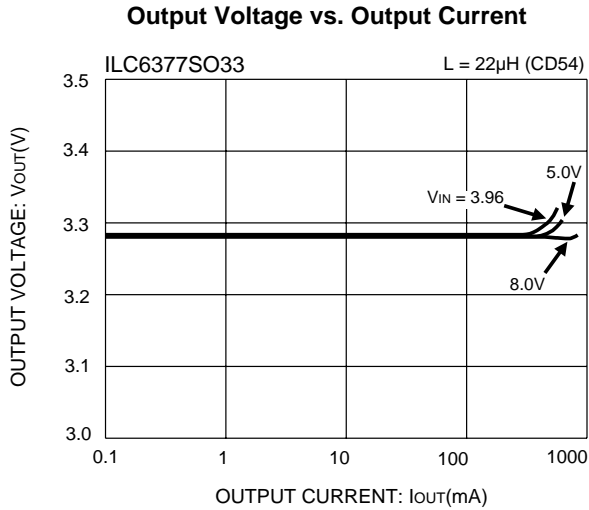

Typical Performance Characteristics

General conditions for all curves: Circuit 1; L = 20μH (Sumida, CD54), C_{IN} = 47μF (tantalum) with 0.1μF (ceramic), C_L = 47μH (tantalum) SS12 schottky diode, C_{SS} = 4700pF (ceramic), T_A = 25°C unless otherwise noted.

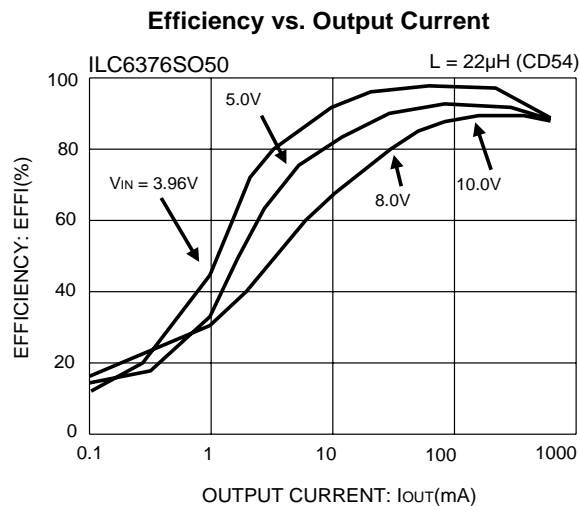
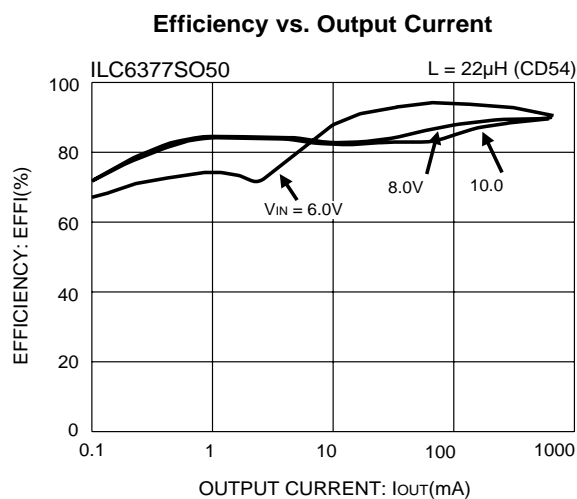
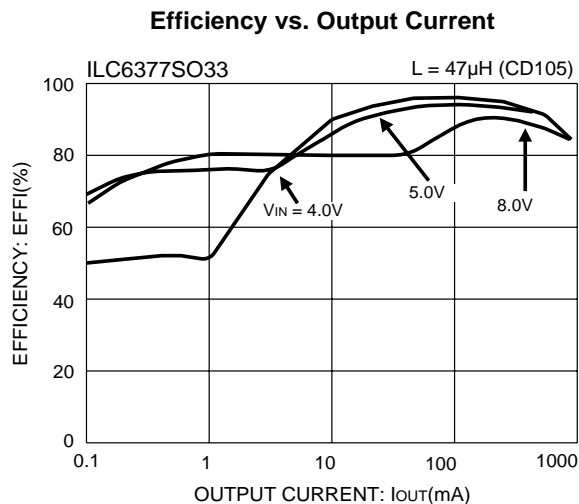
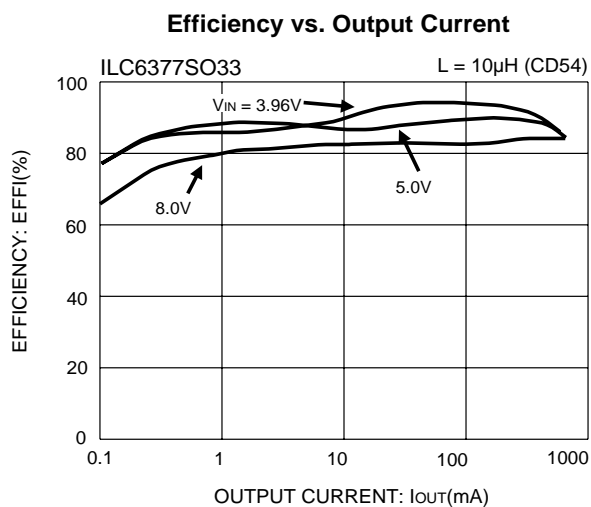
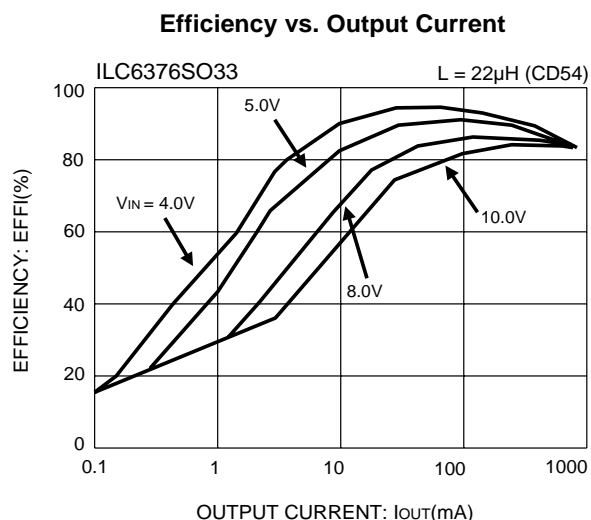
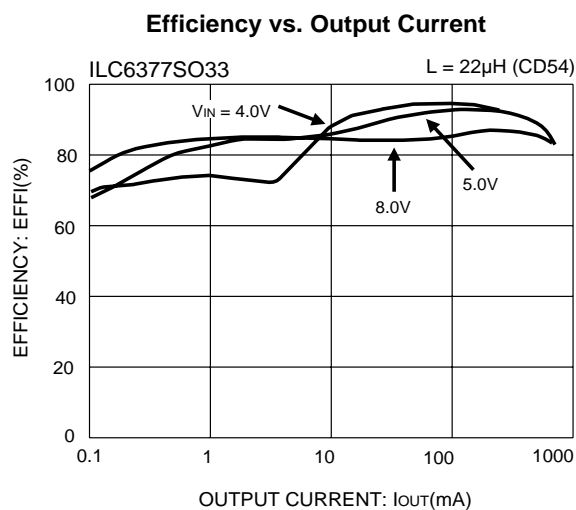

Typical Performance Characteristics

General conditions for all curves: Circuit 1; L = 20 μ H (Sumida, CD54), C_{IN} = 47 μ F (tantalum) with 0.1 μ F (ceramic), C_L = 47 μ H (tantalum) SS12 schottky diode, C_{SS} = 4700pF (ceramic), T_A = 25°C unless otherwise noted.

Output vs. Ambient Temperature

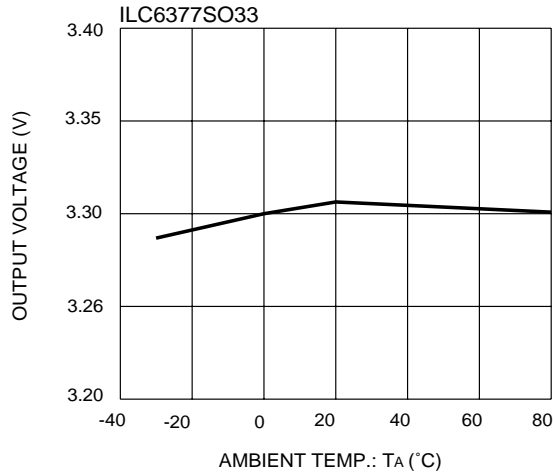

Stand-by Current vs. Ambient Temperature

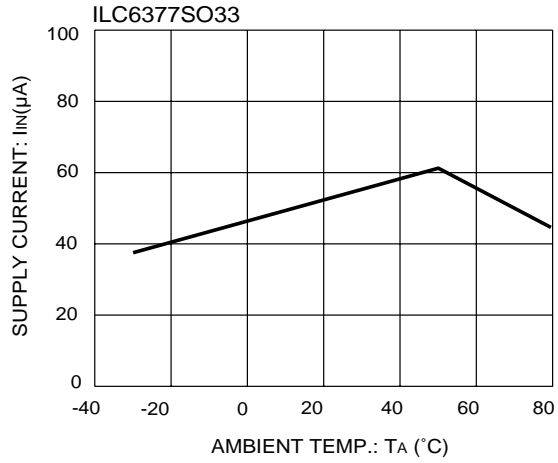

Output Voltage vs. Ambient Temperature

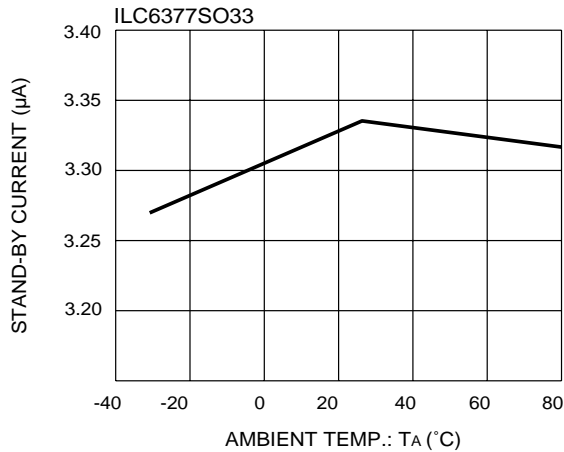

On Resistance vs. Ambient Temperature

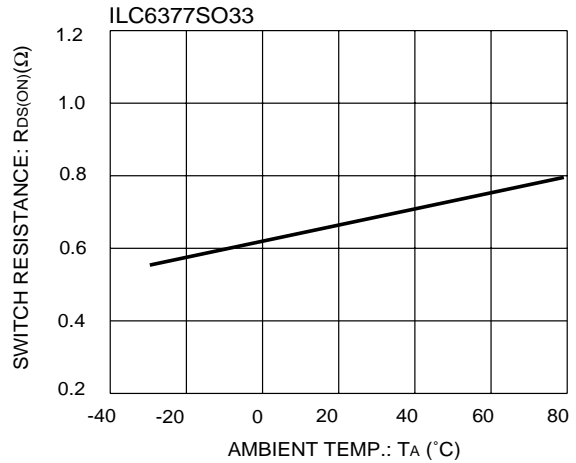

Oscillation Frequency vs. Ambient Temperature

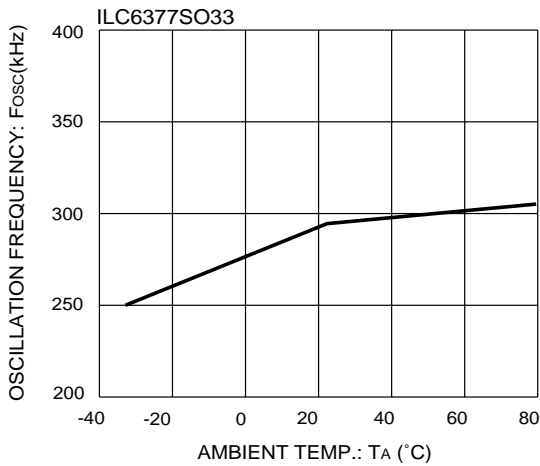

PFM Duty Ratio vs. Ambient Temperature

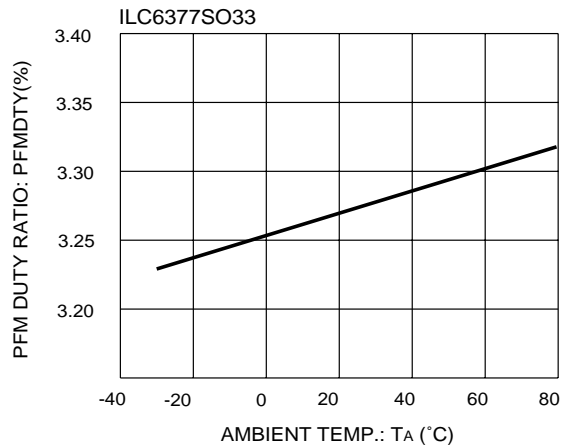

Typical Performance Characteristics

General conditions for all curves: Circuit 1; L = 20 μ H (Sumida, CD54), C_{IN} = 47 μ F (tantalum) with 0.1 μ F (ceramic), C_L = 47 μ H (tantalum) SS12 schottky diode, C_{SS} = 4700pF (ceramic), T_A = 25°C unless otherwise noted.

Efficiency vs. Ambient Temperature

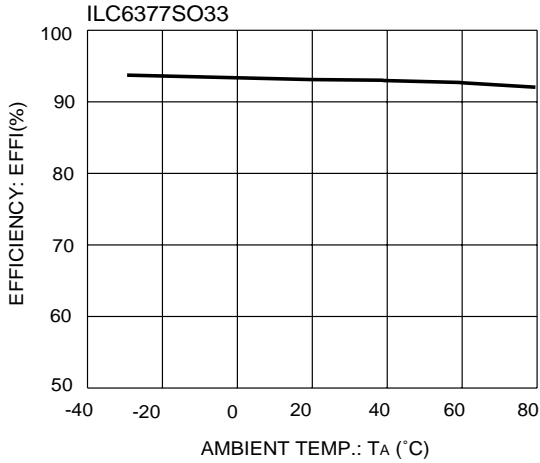

Minimum Operating Voltage vs. Ambient Temperature

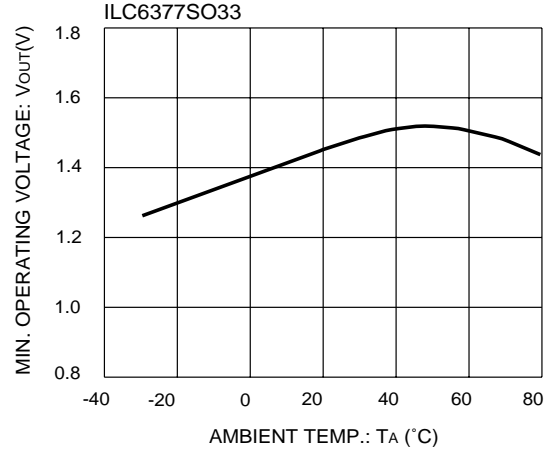

Soft-Start Time vs. Ambient Temperature

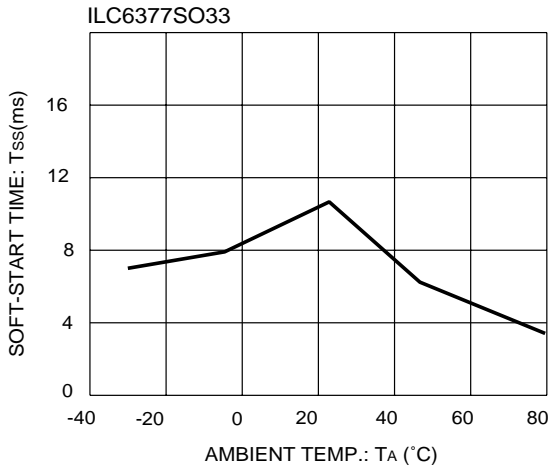

CE "H" Voltage vs. Ambient Temperature

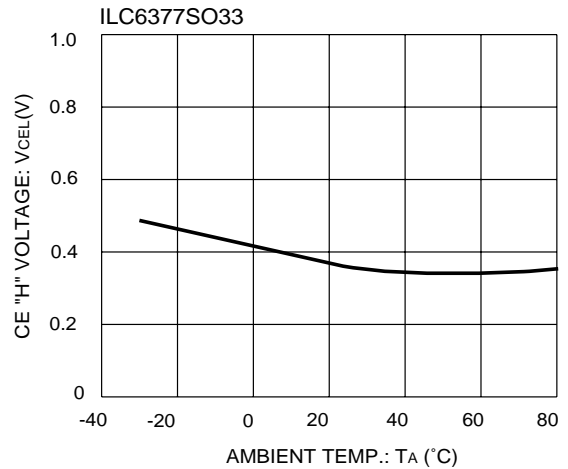

CE "L" Voltage vs. Ambient Temperature

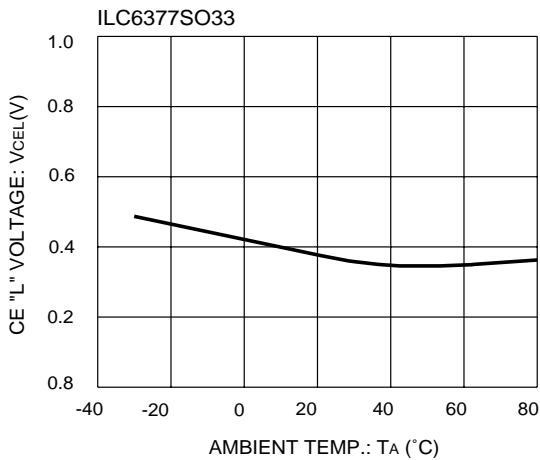

Ordering Information	
ILC6376SO33	3.3V, 300kHz step-down PWM converter
ILC6376SO50	5V, 300kHz step-down PWM converter
ILC6376ADJ	Adjustable, 300kHz step-down PWM converter
ILC6377SO33	3.3V, 300kHz step-down PWM/PFM converter
ILC6377SO50	5V, 300kHz step-down PWM/PFM converter
ILC6377SOADJ	Adjustable, 300kHz step-down PWM/PFM converter

DISCLAIMER

FAIRCHILD SEMICONDUCTOR RESERVES THE RIGHT TO MAKE CHANGES WITHOUT FURTHER NOTICE TO ANY PRODUCTS HEREIN TO IMPROVE RELIABILITY, FUNCTION OR DESIGN. FAIRCHILD DOES NOT ASSUME ANY LIABILITY ARISING OUT OF THE APPLICATION OR USE OF ANY PRODUCT OR CIRCUIT DESCRIBED HEREIN; NEITHER DOES IT CONVEY ANY LICENSE UNDER ITS PATENT RIGHTS, NOR THE RIGHTS OF OTHERS.

LIFE SUPPORT POLICY

FAIRCHILD'S PRODUCTS ARE NOT AUTHORIZED FOR USE AS CRITICAL COMPONENTS IN LIFE SUPPORT DEVICES OR SYSTEMS WITHOUT THE EXPRESS WRITTEN APPROVAL OF THE PRESIDENT OF FAIRCHILD SEMICONDUCTOR CORPORATION. As used herein:

1. Life support devices or systems are devices or systems which, (a) are intended for surgical implant into the body, or (b) support or sustain life, and (c) whose failure to perform when properly used in accordance with instructions for use provided in the labeling, can be reasonably expected to result in a significant injury of the user.
2. A critical component in any component of a life support device or system whose failure to perform can be reasonably expected to cause the failure of the life support device or system, or to affect its safety or effectiveness.