

## FEATURES

- ◆ Avalanche Rugged Technology
- ◆ Rugged Gate Oxide Technology
- ◆ Lower Input Capacitance
- ◆ Improved Gate Charge
- ◆ Extended Safe Operating Area
- ◆ Lower Leakage Current: 10µA (Max.) @  $V_{DS} = 250V$
- ◆ Lower  $R_{DS(ON)}$ : 0.327Ω (Typ.)

$$BV_{DSS} = 250 V$$

$$R_{DS(on)} = 0.45\Omega$$

$$I_D = 8.1 A$$

TO-220

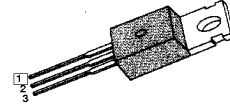

1.Gate 2. Drain 3. Source

## Absolute Maximum Ratings

Symbol	Characteristic	Value	Units
$V_{DSS}$	Drain-to-Source Voltage	250	V
$I_D$	Continuous Drain Current ( $T_C=25^\circ C$ )	8.1	A
	Continuous Drain Current ( $T_C=100^\circ C$ )	5.1	
$I_{DM}$	Drain Current-Pulsed (1)	32	A
$V_{GS}$	Gate-to-Source Voltage	$\pm 30$	V
$E_{AS}$	Single Pulsed Avalanche Energy (2)	205	mJ
$I_{AR}$	Avalanche Current (1)	8.1	A
$E_{AR}$	Repetitive Avalanche Energy (1)	7.4	mJ
dv/dt	Peak Diode Recovery dv/dt (3)	4.8	V/ns
$P_D$	Total Power Dissipation ( $T_C=25^\circ C$ )	74	W
	Linear Derating Factor	0.59	
$T_J, T_{STG}$	Operating Junction and Storage Temperature Range	- 55 to +150	°C
$T_L$	Maximum Lead Temp. for Soldering Purposes, 1/8. from case for 5-seconds	300	

## Thermal Resistance

Symbol	Characteristic	Typ.	Max.	Units
$R_{\theta JC}$	Junction-to-Case	--	1.69	°C/W
$R_{\theta CS}$	Case-to-Sink	0.5	--	
$R_{\theta JA}$	Junction-to-Ambient	--	62.5	

**FAIRCHILD**  
SEMICONDUCTOR™

©1999 Fairchild Semiconductor Corporation

Rev. B

### Electrical Characteristics (T<sub>C</sub>=25°C unless otherwise specified)

Symbol	Characteristic	Min.	Typ.	Max.	Units	Test Condition
BV <sub>DSS</sub>	Drain-Source Breakdown Voltage	250	--	--	V	V <sub>GS</sub> =0V, I <sub>D</sub> =250μA
ΔBV/ΔT <sub>J</sub>	Breakdown Voltage Temp. Coeff.	--	0.29	--	V/°C	I <sub>D</sub> =250μA <b>See Fig 7</b>
V <sub>GS(th)</sub>	Gate Threshold Voltage	2.0	--	4.0	V	V <sub>DS</sub> =5V, I <sub>D</sub> =250μA
I <sub>GSS</sub>	Gate-Source Leakage, Forward	--	--	100	nA	V <sub>GS</sub> =30V
	Gate-Source Leakage, Reverse	--	--	-100		V <sub>GS</sub> =-30V
I <sub>DSS</sub>	Drain-to-Source Leakage Current	--	--	10	μA	V <sub>DS</sub> =250V
		--	--	100		V <sub>DS</sub> =200V, T <sub>C</sub> =125°C
R <sub>DS(on)</sub>	Static Drain-Source On-State Resistance	--	--	0.45	Ω	V <sub>GS</sub> =10V, I <sub>D</sub> =4.05A (4)
g <sub>fs</sub>	Forward Transconductance	--	6.1	--	Ω	V <sub>DS</sub> =40V, I <sub>D</sub> =4.05A (4)
C <sub>iss</sub>	Input Capacitance	--	730	950	pF	V <sub>GS</sub> =0V, V <sub>DS</sub> =25V, f = 1MHz <b>See Fig 5</b>
C <sub>oss</sub>	Output Capacitance	--	110	130		
C <sub>rss</sub>	Reverse Transfer Capacitance	--	50	60		
t <sub>d(on)</sub>	Turn-On Delay Time	--	13	40	ns	V <sub>DD</sub> =125V, I <sub>D</sub> =8.1A, R <sub>G</sub> =12Ω <b>See Fig 13</b> (4) (5)
t <sub>r</sub>	Rise Time	--	14	40		
t <sub>d(off)</sub>	Turn-Off Delay Time	--	53	120		
t <sub>f</sub>	Fall Time	--	21	50		
Q <sub>g</sub>	Total Gate Charge	--	30	40	nC	V <sub>DS</sub> =200V, V <sub>GS</sub> =10V, I <sub>D</sub> =8.1A <b>See Fig 6 &amp; Fig 12</b> (4) (5)
Q <sub>gs</sub>	Gate-Source Charge	--	5.8	--		
Q <sub>gd</sub>	Gate-Drain (. Miller. ) Charge	--	13.5	--		

### Source-Drain Diode Ratings and Characteristics

Symbol	Characteristic	Min.	Typ.	Max.	Units	Test Condition
I <sub>S</sub>	Continuous Source Current	--	--	8.1	A	Integral reverse pn-diode in the MOSFET
I <sub>SM</sub>	Pulsed-Source Current (1)	--	--	32		
V <sub>SD</sub>	Diode Forward Voltage (4)	--	--	1.5	V	T <sub>J</sub> =25°C, I <sub>S</sub> =8.1A, V <sub>GS</sub> =0V
t <sub>rr</sub>	Reverse Recovery Time	--	190	--	ns	T <sub>J</sub> =25°C, I <sub>F</sub> =8.1A
Q <sub>rr</sub>	Reverse Recovery Charge	--	1.28	--	μC	di <sub>F</sub> /dt=100A/μs (4)

#### Notes;

- (1) Repetitive Rating; Pulse Width Limited by Maximum Junction Temperature
- (2) L=5mH, I<sub>AS</sub>=8.1A, V<sub>DD</sub>=50V, R<sub>G</sub>=27Ω, Starting T<sub>J</sub>=25°C
- (3) I<sub>SD</sub> ≤ 8.1A, di/dt ≤ 210A/μs, V<sub>DD</sub> ≤ BV<sub>DSS</sub>, Starting T<sub>J</sub>=25°C
- (4) Pulse Test: Pulse Width = 250μs, Duty Cycle ≤ 2%
- (5) Essentially Independent of Operating Temperature

Fig 1. Output Characteristics

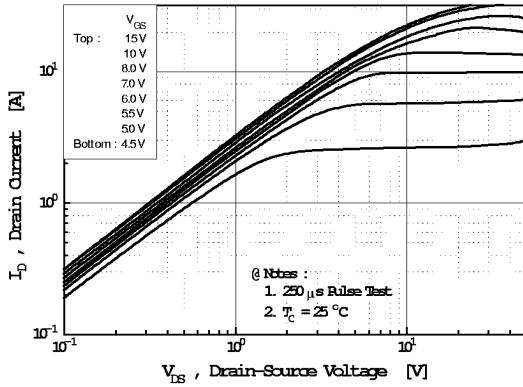

Fig 2. Transfer Characteristics

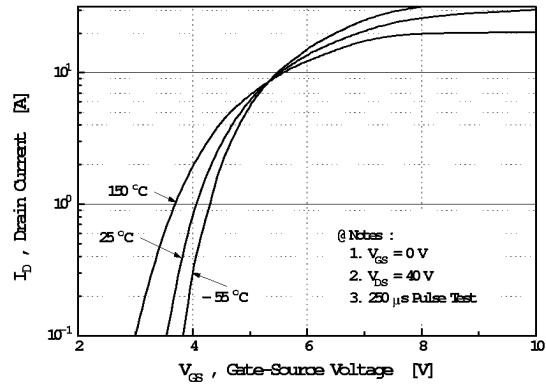

Fig 3. On-Resistance vs. Drain Current

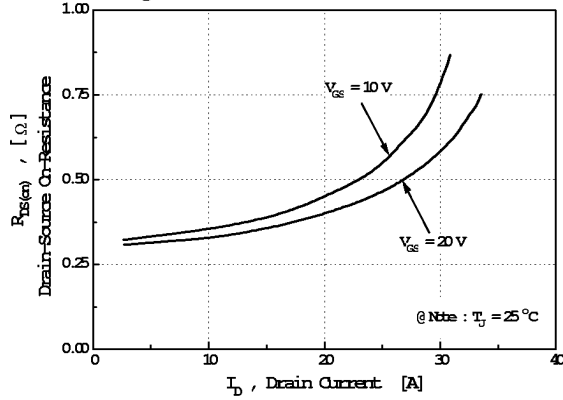

Fig 4. Source-Drain Diode Forward Voltage

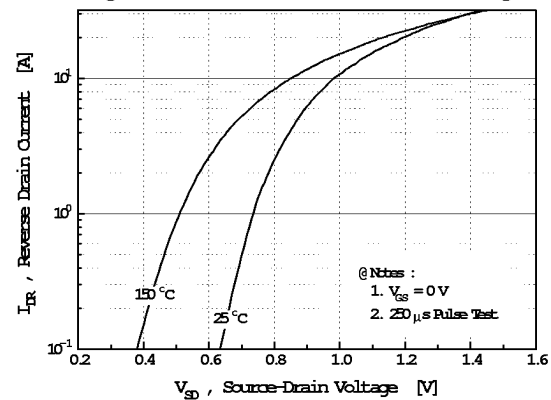

Fig 5. Capacitance vs. Drain-Source Voltage

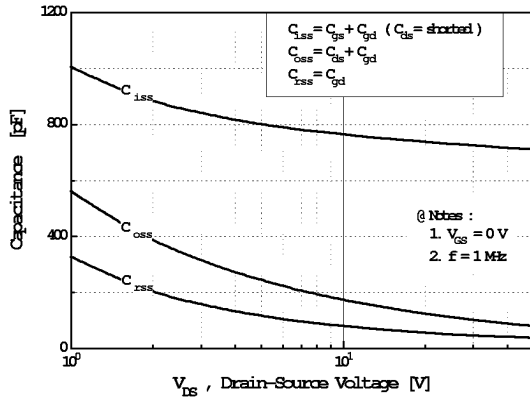
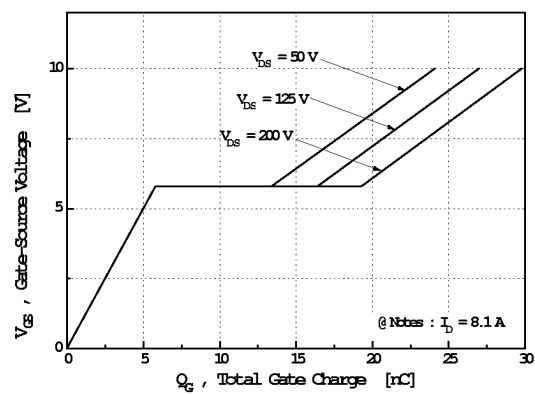
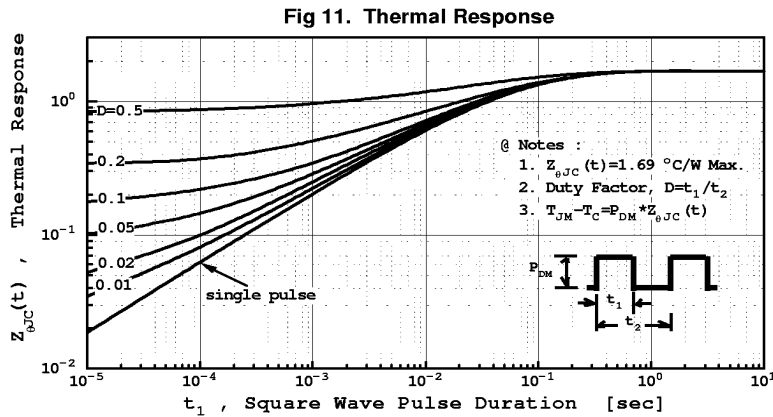
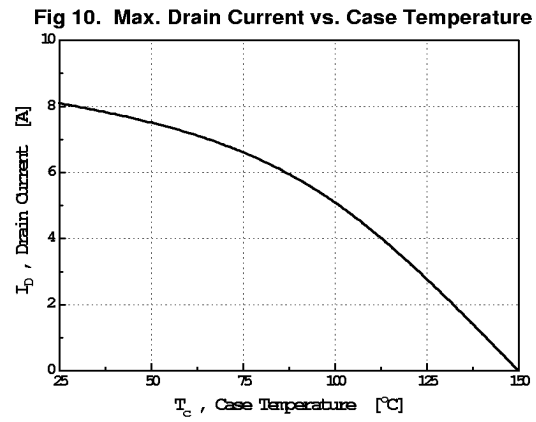
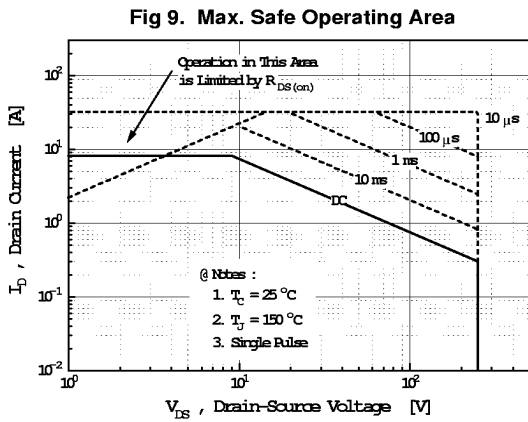
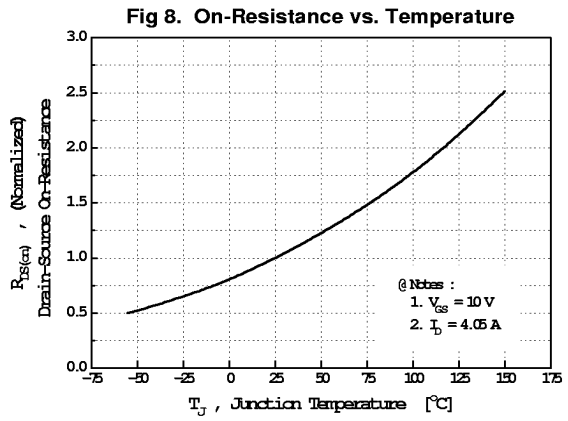
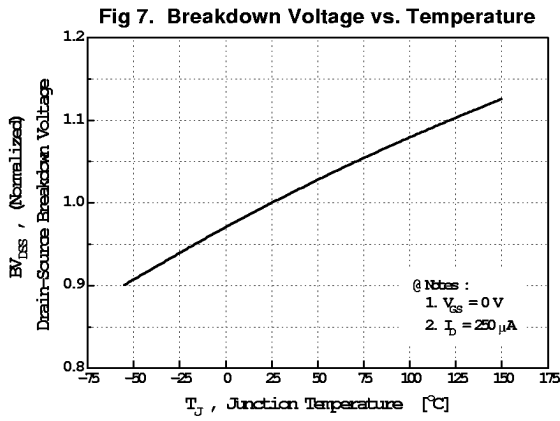
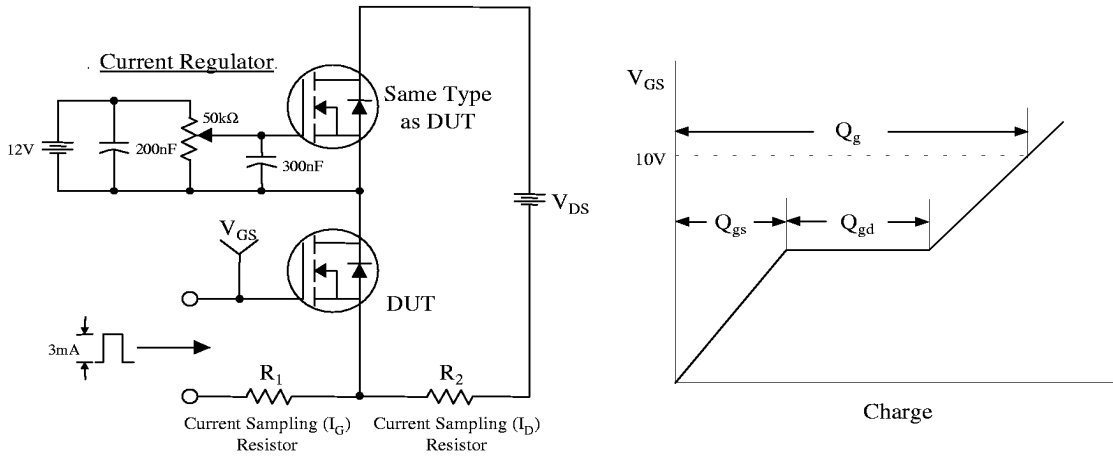

Fig 6. Gate Charge vs. Gate-Source Voltage

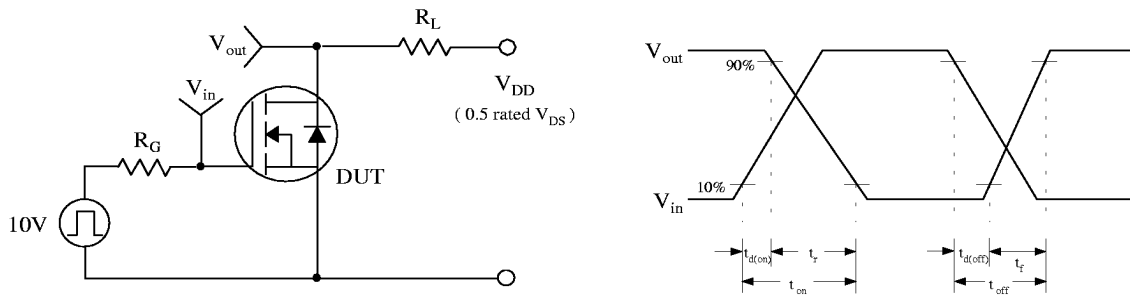



**Fig 12. Gate Charge Test Circuit & Waveform**



**Fig 13. Resistive Switching Test Circuit & Waveforms**



**Fig 14. Unclamped Inductive Switching Test Circuit & Waveforms**

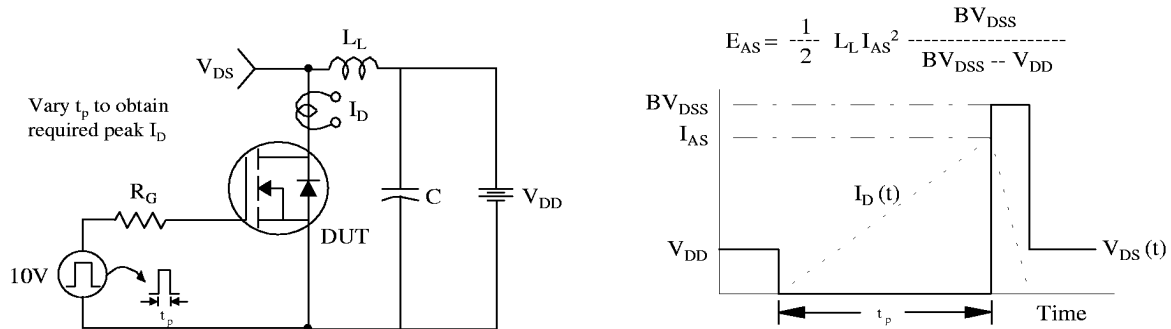

Fig 15. Peak Diode Recovery dv/dt Test Circuit & Waveforms

