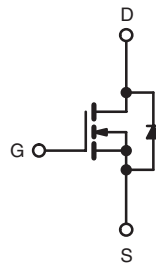
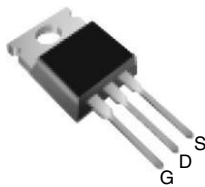

Power MOSFET

PRODUCT SUMMARY		
V_{DS} (V)	300	
$R_{DS(on)}$ (Ω)	$V_{GS} = 10$ V	0.75
Q_g (Max.) (nC)	17	
Q_{gs} (nC)	4.8	
Q_{gd} (nC)	7.6	
Configuration	Single	

TO-220

N-Channel MOSFET

FEATURES

- Reduced Gate Drive Requirement
- Enhanced 30 V V_{GS} Rating
- Reduced C_{iss} , C_{oss} , C_{rss}
- Extremely High Frequency Operation
- Repetitive Avalanche Rated
- Lead (Pb)-free Available



Available

RoHS*
COMPLIANT

DESCRIPTION

This new series of low charge Power MOSFETs achieve significantly lower gate charge over conventional Power MOSFETs. Utilizing the new LCDMOS technology, the device improvements are achieved without added product cost, allowing for reduced gate drive requirements and total system savings. In addition, reduced switching losses and improved efficiency are achievable in a variety of high frequency applications. Frequencies of a few MHz at high current are possible using the new low charge Power MOSFETs.

These device improvements combined with the proven ruggedness and reliability that are characteristics of Power MOSFETs offer the designer a new standard in power transistors for switching applications.

ORDERING INFORMATION	
Package	TO-220
Lead (Pb)-free	IRF737LCPbF SiHF737LC-E3
SnPb	IRF737LC SiHF737LC

ABSOLUTE MAXIMUM RATINGS $T_C = 25$ °C, unless otherwise noted				
PARAMETER	SYMBOL	LIMIT	UNIT	
Drain-Source Voltage	V_{DS}	300	V	
Gate-Source Voltage	V_{GS}	± 30		
Continuous Drain Current	I_D	V_{GS} at 10 V $T_C = 25$ °C	6.1	A
		$T_C = 100$ °C	3.9	
Pulsed Drain Current ^a	I_{DM}	24		
Linear Derating Factor		0.59	W/°C	
Single Pulse Avalanche Energy ^b	E_{AS}	120	mJ	
Avalanche Current ^a	I_{AR}	6.1	A	
Repetitive Avalanche Energy ^a	E_{AR}	7.4	mJ	
Maximum Power Dissipation	P_D	74	W	
Peak Diode Recovery dV/dt^c	dV/dt	3.4	V/ns	
Operating Junction and Storage Temperature Range	T_J, T_{stg}	- 55 to + 150	°C	
Soldering Recommendations (Peak Temperature)	for 10 s	300 ^d		
Mounting Torque	6-32 or M3 screw	10		lbf · in
		1.1	N · m	

Notes



- Repetitive rating; pulse width limited by maximum junction temperature (see fig. 11).
- $V_{DD} = 25$ V, starting $T_J = 25$ °C, $L = 5.7$ mH, $R_G = 25$ Ω , $I_{AS} = 6.1$ A (see fig. 12).
- $I_{SD} \leq 6.1$ A, $dI/dt \leq 270$ A/ μ s, $V_{DD} \leq V_{DS}$, $T_J \leq 150$ °C.
- 1.6 mm from case.

* Pb containing terminations are not RoHS compliant, exemptions may apply

THERMAL RESISTANCE RATINGS				
PARAMETER	SYMBOL	TYP.	MAX.	UNIT
Maximum Junction-to-Ambient	R_{thJA}	-	62	°C/W
Case-to-Sink, Flat, Greased Surface	R_{thCS}	0.50	-	
Maximum Junction-to-Case (Drain)	R_{thJC}	-	1.7	

Note

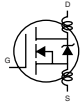
a. When mounted on 1" square PCB (FR-4 or G-10 material).

SPECIFICATIONS $T_J = 25\text{ }^\circ\text{C}$, unless otherwise noted							
PARAMETER	SYMBOL	TEST CONDITIONS		MIN.	TYP.	MAX.	UNIT
Static							
Drain-Source Breakdown Voltage	V_{DS}	$V_{GS} = 0\text{ V}, I_D = 250\text{ }\mu\text{A}$		300	-	-	V
V_{DS} Temperature Coefficient	$\Delta V_{DS}/T_J$	Reference to $25\text{ }^\circ\text{C}$, $I_D = 1\text{ mA}$		-	0.391	-	V/°C
Gate-Source Threshold Voltage	$V_{GS(th)}$	$V_{DS} = V_{GS}, I_D = 250\text{ }\mu\text{A}$		2.0	-	4.0	V
Gate-Source Leakage	I_{GSS}	$V_{GS} = \pm 20\text{ V}$		-	-	± 100	nA
Zero Gate Voltage Drain Current	I_{DSS}	$V_{DS} = 300\text{ V}, V_{GS} = 0\text{ V}$		-	-	25	μA
		$V_{DS} = 240\text{ V}, V_{GS} = 0\text{ V}, T_J = 150\text{ }^\circ\text{C}$		-	-	250	
Drain-Source On-State Resistance	$R_{DS(on)}$	$V_{GS} = 10\text{ V}$	$I_D = 3.7\text{ A}^b$	-	-	0.75	Ω
Forward Transconductance	g_{fs}	$V_{DS} = 50\text{ V}, I_D = 3.7\text{ A}^b$		2.7	-	-	S
Dynamic							
Input Capacitance	C_{iss}	$V_{GS} = 0\text{ V}, V_{DS} = 25\text{ V}, f = 1.0\text{ MHz}$, see fig. 5		-	430	-	pF
Output Capacitance	C_{oss}			-	120	-	
Reverse Transfer Capacitance	C_{riss}			-	9.2	-	
Total Gate Charge	Q_g	$V_{GS} = 10\text{ V}$	$I_D = 6.1\text{ A}, V_{DS} = 240\text{ V}$, see fig. 6 and 13 ^b	-	-	17	nC
Gate-Source Charge	Q_{gs}			-	-	4.8	
Gate-Drain Charge	Q_{gd}			-	-	7.6	
Turn-On Delay Time	$t_{d(on)}$	$V_{DD} = 150\text{ V}, I_D = 6.1\text{ A}, R_G = 12\text{ }\Omega, R_D = 24\text{ }\Omega$, see fig. 10 ^b		-	6.6	-	ns
Rise Time	t_r			-	21	-	
Turn-Off Delay Time	$t_{d(off)}$			-	13	-	
Fall Time	t_f			-	12	-	
Internal Drain Inductance	L_D	Between lead, 6 mm (0.25") from package and center of die contact 		-	4.5	-	nH
Internal Source Inductance	L_S			-	7.5	-	
Drain-Source Body Diode Characteristics							
Continuous Source-Drain Diode Current	I_S	MOSFET symbol showing the integral reverse p-n junction diode 		-	-	6.1	A
Pulsed Diode Forward Current ^a	I_{SM}			-	-	24	
Body Diode Voltage	V_{SD}	$T_J = 25\text{ }^\circ\text{C}, I_S = 6.1\text{ A}, V_{GS} = 0\text{ V}^b$		-	-	1.6	V
Body Diode Reverse Recovery Time	t_{rr}	$T_J = 25\text{ }^\circ\text{C}, I_F = 6.1\text{ A}, di/dt = 100\text{ A}/\mu\text{s}^b$		-	320	490	ns
Body Diode Reverse Recovery Charge	Q_{rr}			-	1.5	2.2	μC

Notes

- Repetitive rating; pulse width limited by maximum junction temperature (see fig. 11).
- Pulse width $\leq 300\text{ }\mu\text{s}$; duty cycle $\leq 2\%$.

TYPICAL CHARACTERISTICS 25 °C, unless otherwise noted

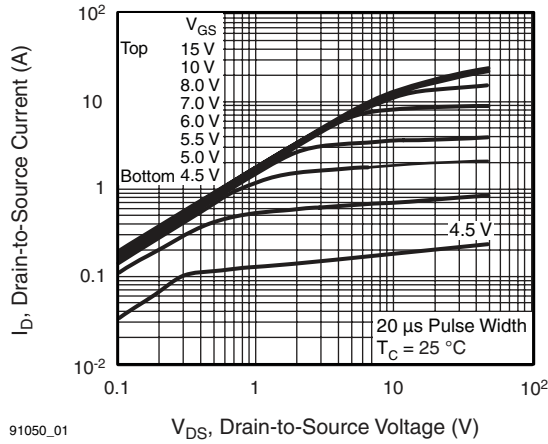

91050_01

Fig. 1 - Typical Output Characteristics, $T_C = 25\text{ °C}$

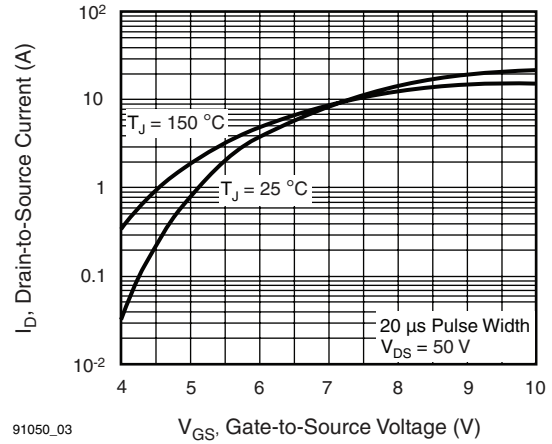

91050_03

Fig. 3 - Typical Transfer Characteristics

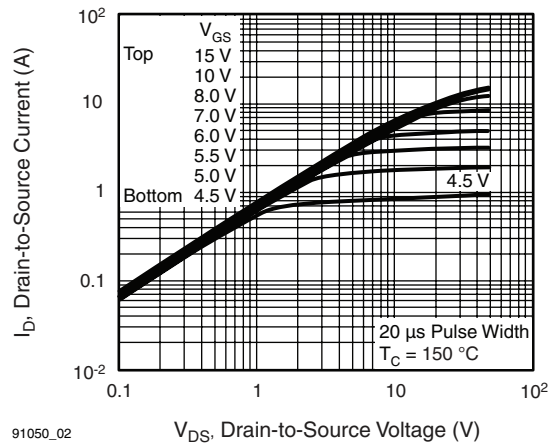

91050_02

Fig. 2 - Typical Output Characteristics, $T_C = 150\text{ °C}$

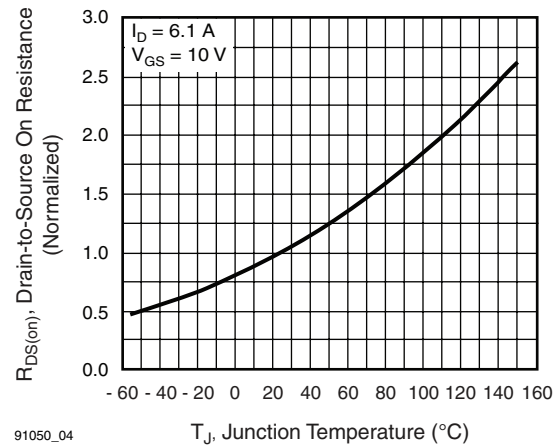

91050_04

Fig. 4 - Normalized On-Resistance vs. Temperature

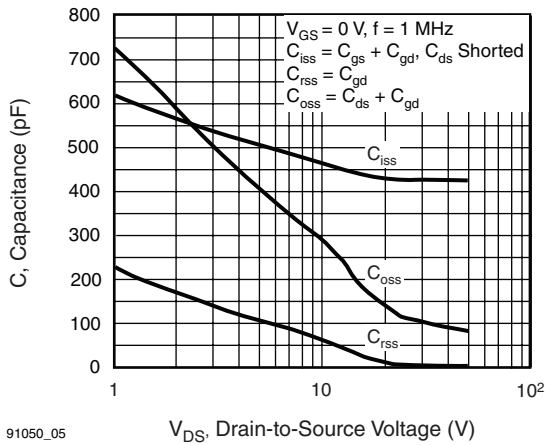

91050_05

Fig. 5 - Typical Capacitance vs. Drain-to-Source Voltage

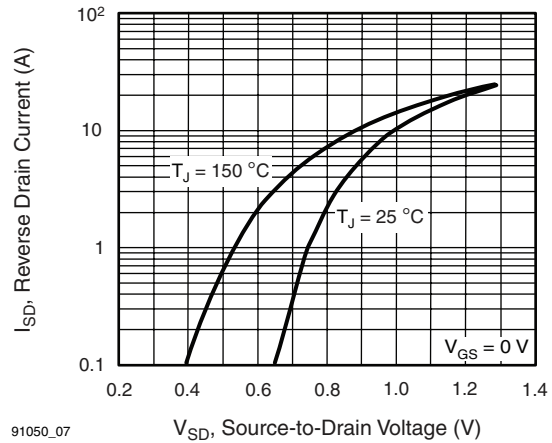

91050_07

Fig. 7 - Typical Source-Drain Diode Forward Voltage

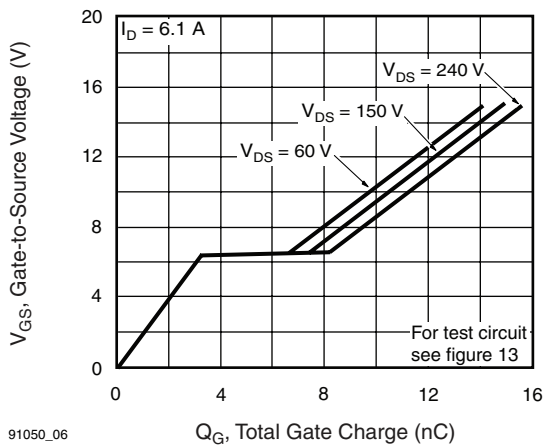

91050_06

Fig. 6 - Typical Gate Charge vs. Gate-to-Source Voltage

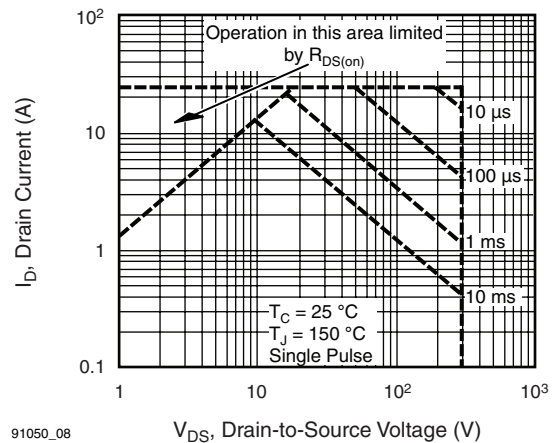

91050_08

Fig. 8 - Maximum Safe Operating Area

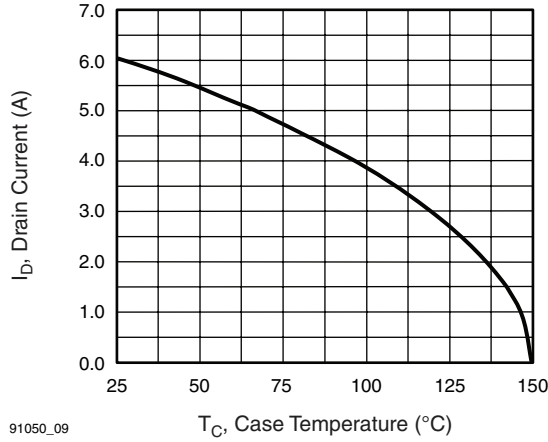

Fig. 9 - Maximum Drain Current vs. Case Temperature

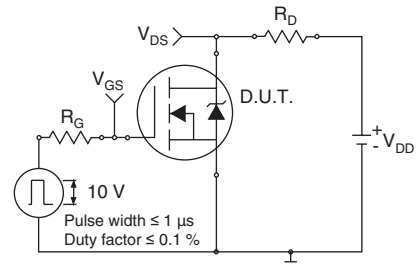

Fig. 10a - Switching Time Test Circuit

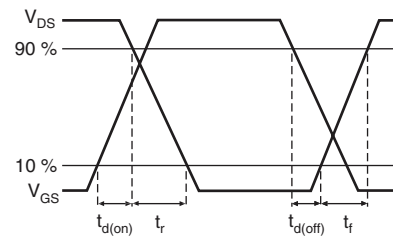

Fig. 10b - Switching Time Waveforms

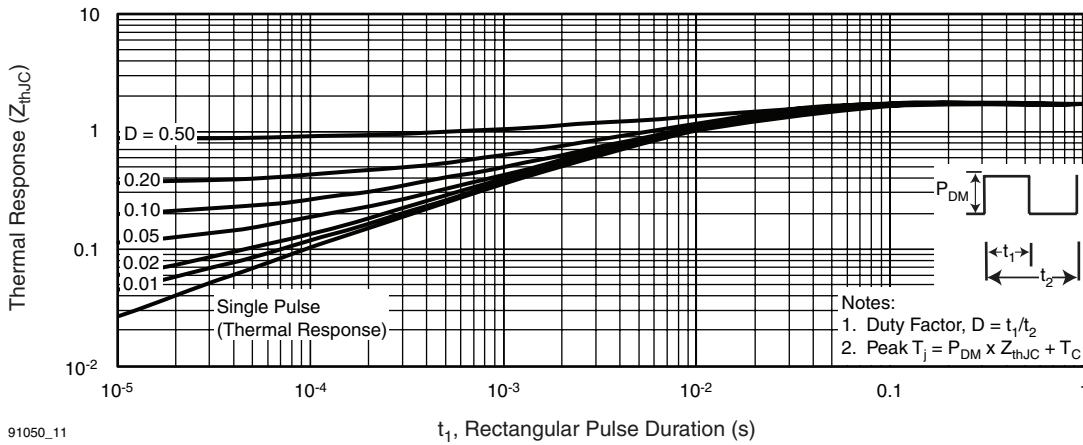

Fig. 11 - Maximum Effective Transient Thermal Impedance, Junction-to-Case

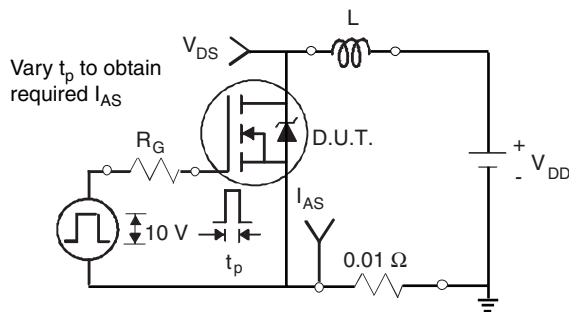

Fig. 12a - Unclamped Inductive Test Circuit

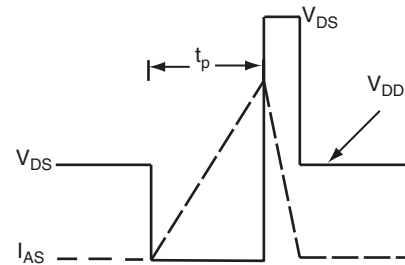

Fig. 12b - Unclamped Inductive Waveforms

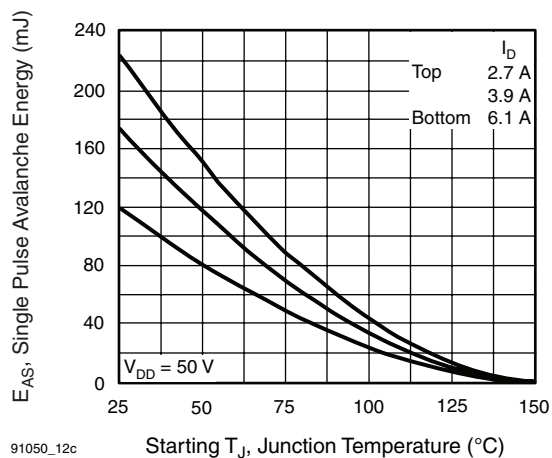

Fig. 12c - Maximum Avalanche Energy vs. Drain Current

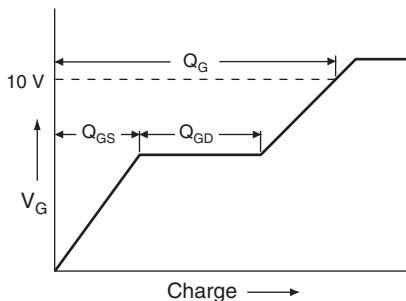

Fig. 13a - Basic Gate Charge Waveform

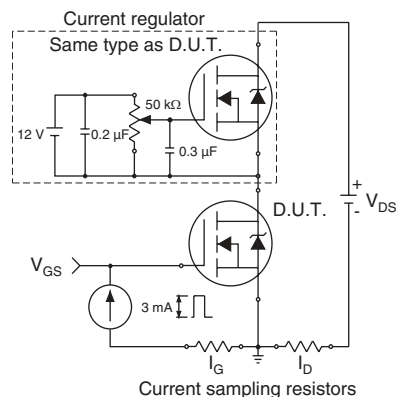
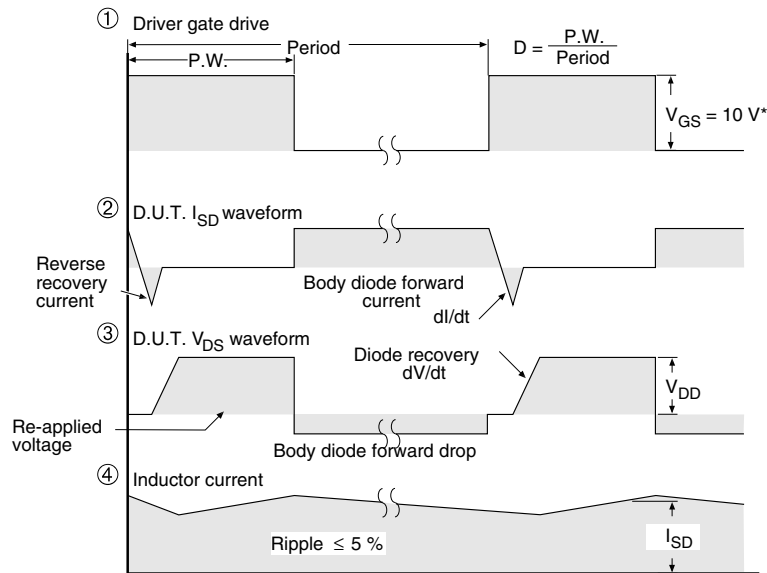
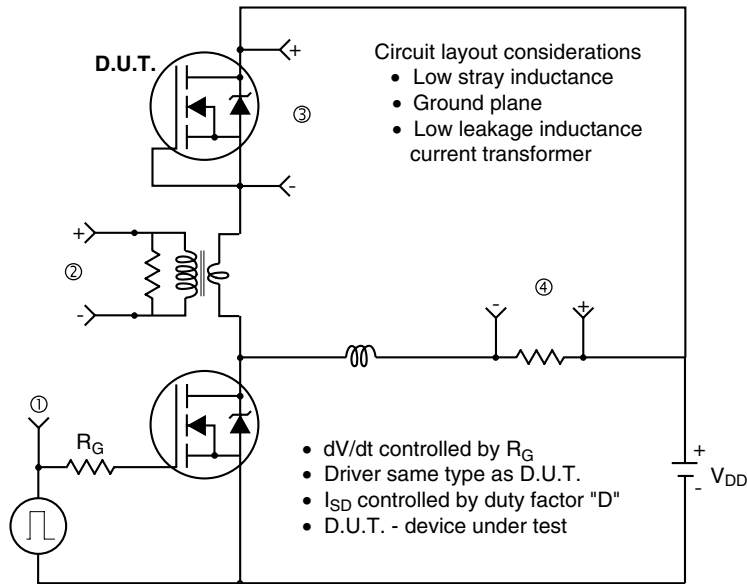

Fig. 13b - Gate Charge Test Circuit

Peak Diode Recovery dV/dt Test Circuit



* $V_{GS} = 5 V$ for logic level devices

Fig. 14 - For N-Channel

Vishay Siliconix maintains worldwide manufacturing capability. Products may be manufactured at one of several qualified locations. Reliability data for Silicon Technology and Package Reliability represent a composite of all qualified locations. For related documents such as package/tape drawings, part marking, and reliability data, see www.vishay.com/ppg?91050.



Disclaimer

All product specifications and data are subject to change without notice.

Vishay Intertechnology, Inc., its affiliates, agents, and employees, and all persons acting on its or their behalf (collectively, "Vishay"), disclaim any and all liability for any errors, inaccuracies or incompleteness contained herein or in any other disclosure relating to any product.

Vishay disclaims any and all liability arising out of the use or application of any product described herein or of any information provided herein to the maximum extent permitted by law. The product specifications do not expand or otherwise modify Vishay's terms and conditions of purchase, including but not limited to the warranty expressed therein, which apply to these products.

No license, express or implied, by estoppel or otherwise, to any intellectual property rights is granted by this document or by any conduct of Vishay.

The products shown herein are not designed for use in medical, life-saving, or life-sustaining applications unless otherwise expressly indicated. Customers using or selling Vishay products not expressly indicated for use in such applications do so entirely at their own risk and agree to fully indemnify Vishay for any damages arising or resulting from such use or sale. Please contact authorized Vishay personnel to obtain written terms and conditions regarding products designed for such applications.

Product names and markings noted herein may be trademarks of their respective owners.