

IRLL014NPbF

HEXFET® Power MOSFET

- Surface Mount
- Advanced Process Technology
- Ultra Low On-Resistance
- Dynamic dv/dt Rating
- Fast Switching
- Fully Avalanche Rated
- Lead-Free

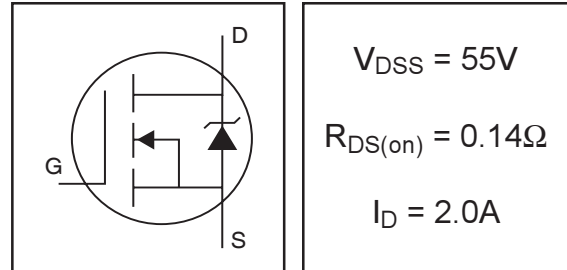

Description

Fifth Generation HEXFETs from International Rectifier utilize advanced processing techniques to achieve extremely low on-resistance per silicon area. This benefit, combined with the fast switching speed and ruggedized device design that HEXFET Power MOSFETs are well known for, provides the designer with an extremely efficient and reliable device for use in a wide variety of applications.

The SOT-223 package is designed for surface-mount using vapor phase, infra red, or wave soldering techniques. Its unique package design allows for easy automatic pick-and-place as with other SOT or SOIC packages but has the added advantage of improved thermal performance due to an enlarged tab for heatsinking. Power dissipation of 1.0W is possible in a typical surface mount application.

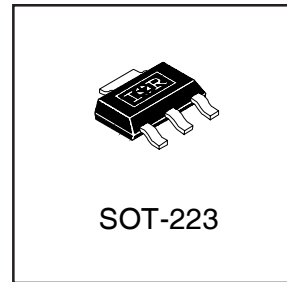

Absolute Maximum Ratings

	Parameter	Max.	Units
$I_D @ T_A = 25^\circ\text{C}$	Continuous Drain Current, $V_{GS} @ 10V^{**}$	2.8	A
$I_D @ T_A = 25^\circ\text{C}$	Continuous Drain Current, $V_{GS} @ 10V^*$	2.0	
$I_D @ T_A = 70^\circ\text{C}$	Continuous Drain Current, $V_{GS} @ 10V^*$	1.6	
I_{DM}	Pulsed Drain Current ①	16	
$P_D @ T_A = 25^\circ\text{C}$	Power Dissipation (PCB Mount)**	2.1	W
$P_D @ T_A = 25^\circ\text{C}$	Power Dissipation (PCB Mount)*	1.0	W
	Linear Derating Factor (PCB Mount)*	8.3	mW/°C
V_{GS}	Gate-to-Source Voltage	± 16	V
E_{AS}	Single Pulse Avalanche Energy②	32	mJ
I_{AR}	Avalanche Current①	2.0	A
E_{AR}	Repetitive Avalanche Energy①*	0.1	mJ
dv/dt	Peak Diode Recovery dv/dt ③	7.2	V/ns
T_J, T_{STG}	Junction and Storage Temperature Range	-55 to + 150	°C

Thermal Resistance

	Parameter	Typ.	Max.	Units
$R_{\theta JA}$	Junction-to-Amb. (PCB Mount, steady state)*	90	120	°C/W
$R_{\theta JA}$	Junction-to-Amb. (PCB Mount, steady state)**	50	60	

* When mounted on FR-4 board using minimum recommended footprint.

** When mounted on 1 inch square copper board, for comparison with other SMD devices.

www.irf.com

Electrical Characteristics @ $T_J = 25^\circ\text{C}$ (unless otherwise specified)

	Parameter	Min.	Typ.	Max.	Units	Conditions
$V_{(BR)DSS}$	Drain-to-Source Breakdown Voltage	55	—	—	V	$V_{GS} = 0V, I_D = 250\mu A$
$\Delta V_{(BR)DSS}/\Delta T_J$	Breakdown Voltage Temp. Coefficient	—	0.015	—	V/°C	Reference to $25^\circ\text{C}, I_D = 1\text{mA}$
$R_{DS(on)}$	Static Drain-to-Source On-Resistance	—	—	0.14	Ω	$V_{GS} = 10V, I_D = 2.0A$ ④
		—	—	0.20		$V_{GS} = 5.0V, I_D = 1.2A$ ④
		—	—	0.28		$V_{GS} = 4.0V, I_D = 1.0A$ ④
$V_{GS(th)}$	Gate Threshold Voltage	1.0	—	2.0	V	$V_{DS} = V_{GS}, I_D = 250\mu A$
g_{fs}	Forward Transconductance	2.3	—	—	S	$V_{DS} = 25V, I_D = 1.0A$
I_{DSS}	Drain-to-Source Leakage Current	—	—	25	μA	$V_{DS} = 55V, V_{GS} = 0V$
		—	—	250		$V_{DS} = 44V, V_{GS} = 0V, T_J = 150^\circ\text{C}$
I_{GSS}	Gate-to-Source Forward Leakage	—	—	100	nA	$V_{GS} = 16V$
	Gate-to-Source Reverse Leakage	—	—	-100		$V_{GS} = -16V$
Q_g	Total Gate Charge	—	9.5	14	nC	$I_D = 2.0A$
Q_{gs}	Gate-to-Source Charge	—	1.1	1.7		$V_{DS} = 44V$
Q_{gd}	Gate-to-Drain ("Miller") Charge	—	3.0	4.4		$V_{GS} = 10V$, See Fig. 6 and 9 ④
$t_{d(on)}$	Turn-On Delay Time	—	5.1	—	ns	$V_{DD} = 28V$
t_r	Rise Time	—	4.9	—		$I_D = 2.0A$
$t_{d(off)}$	Turn-Off Delay Time	—	14	—		$R_G = 6.0\Omega$
t_f	Fall Time	—	2.9	—		$R_D = 14\Omega$, See Fig. 10 ④
C_{iss}	Input Capacitance	—	230	—	pF	$V_{GS} = 0V$
C_{oss}	Output Capacitance	—	66	—		$V_{DS} = 25V$
C_{rss}	Reverse Transfer Capacitance	—	30	—		$f = 1.0\text{MHz}$, See Fig. 5

Source-Drain Ratings and Characteristics

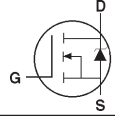
	Parameter	Min.	Typ.	Max.	Units	Conditions
I_S	Continuous Source Current (Body Diode)	—	—	1.3	A	MOSFET symbol showing the integral reverse p-n junction diode. 
I_{SM}	Pulsed Source Current (Body Diode) ①	—	—	16		
V_{SD}	Diode Forward Voltage	—	—	1.0	V	$T_J = 25^\circ\text{C}, I_S = 2.0A, V_{GS} = 0V$ ④
t_{rr}	Reverse Recovery Time	—	41	61	ns	$T_J = 25^\circ\text{C}, I_F = 2.0A$
Q_{rr}	Reverse Recovery Charge	—	73	110	nC	$di/dt = 100A/\mu s$ ④
t_{on}	Forward Turn-On Time	Intrinsic turn-on time is negligible (turn-on is dominated by L_S+L_D)				

Notes:

- ① Repetitive rating; pulse width limited by max. junction temperature. (See fig. 11)
- ② $V_{DD} = 25V$, starting $T_J = 25^\circ\text{C}$, $L = 4.0\text{mH}$
 $R_G = 25\Omega, I_{AS} = 4.0A$. (See Figure 12)
- ③ $I_{SD} \leq 2.0A, di/dt \leq 170A/\mu s, V_{DD} \leq V_{(BR)DSS}, T_J \leq 150^\circ\text{C}$
- ④ Pulse width $\leq 300\mu s$; duty cycle $\leq 2\%$.

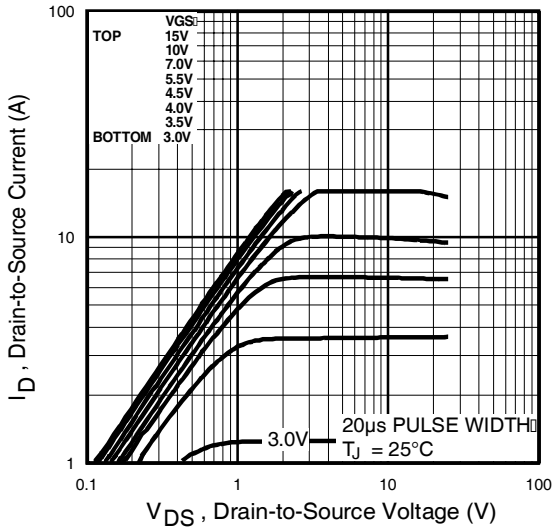

Fig 1. Typical Output Characteristics,

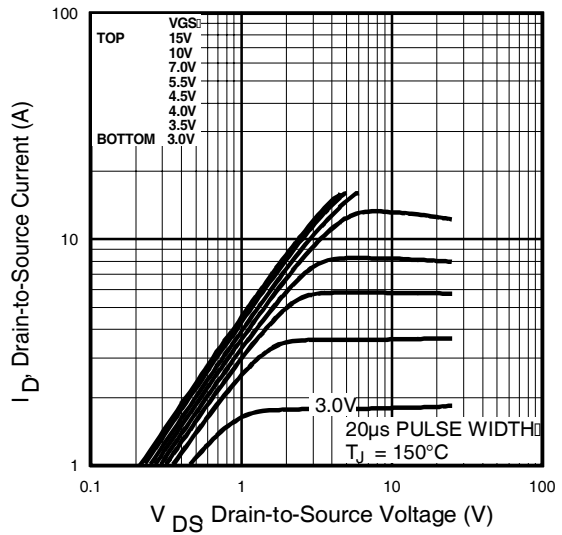

Fig 2. Typical Output Characteristics,

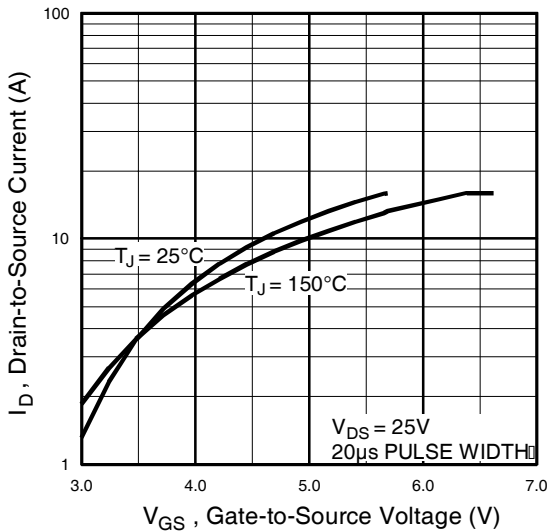

Fig 3. Typical Transfer Characteristics

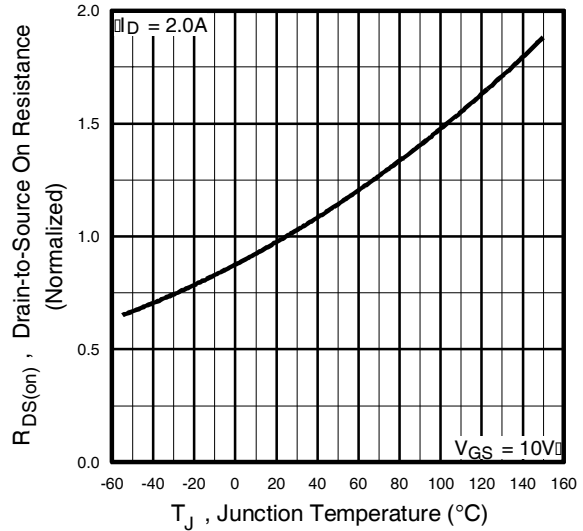

Fig 4. Normalized On-Resistance Vs. Temperature

IRLL014NPbF

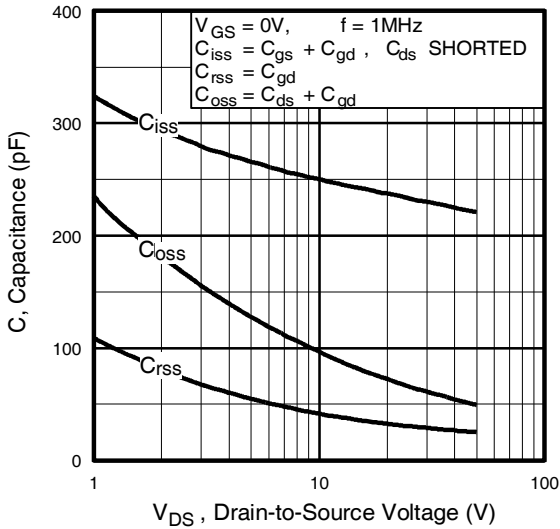

Fig 5. Typical Capacitance Vs. Drain-to-Source Voltage

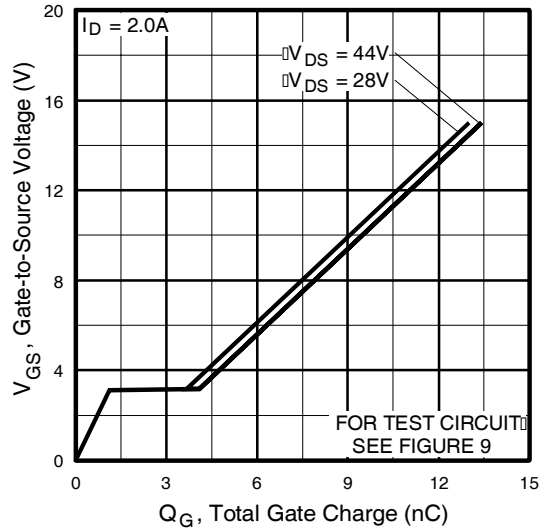

Fig 6. Typical Gate Charge Vs. Gate-to-Source Voltage

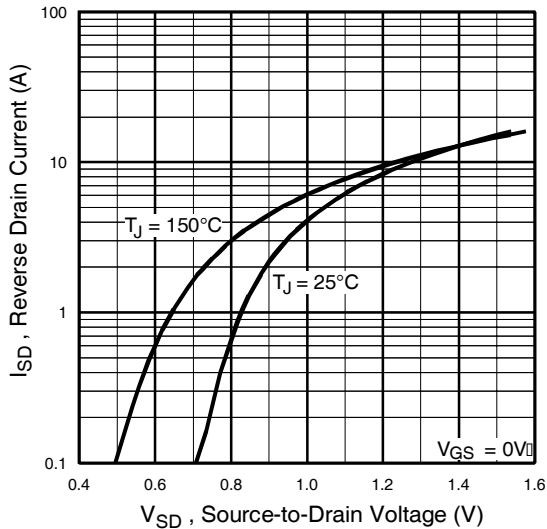

Fig 7. Typical Source-Drain Diode Forward Voltage

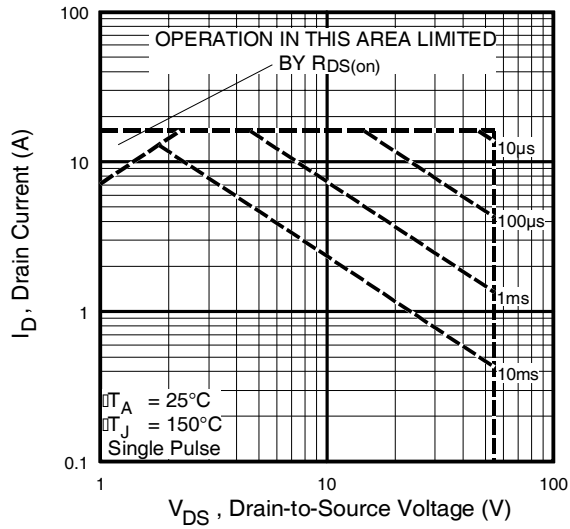

Fig 8. Maximum Safe Operating Area

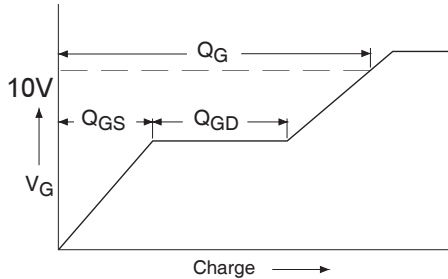

Fig 9a. Basic Gate Charge Waveform

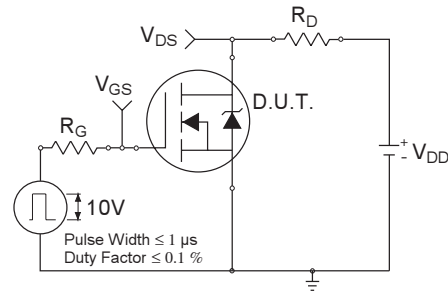

Fig 10a. Switching Time Test Circuit

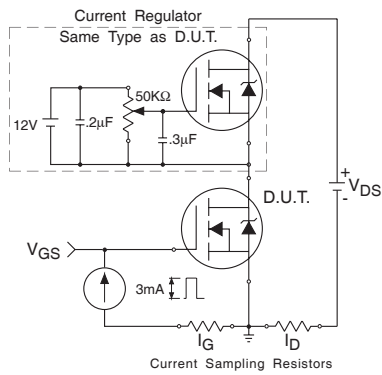

Fig 9b. Gate Charge Test Circuit

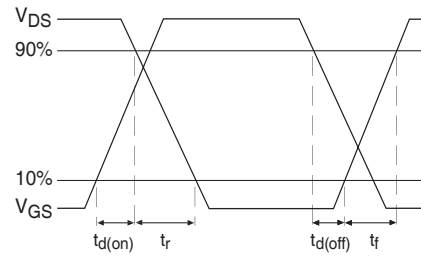

Fig 10b. Switching Time Waveforms

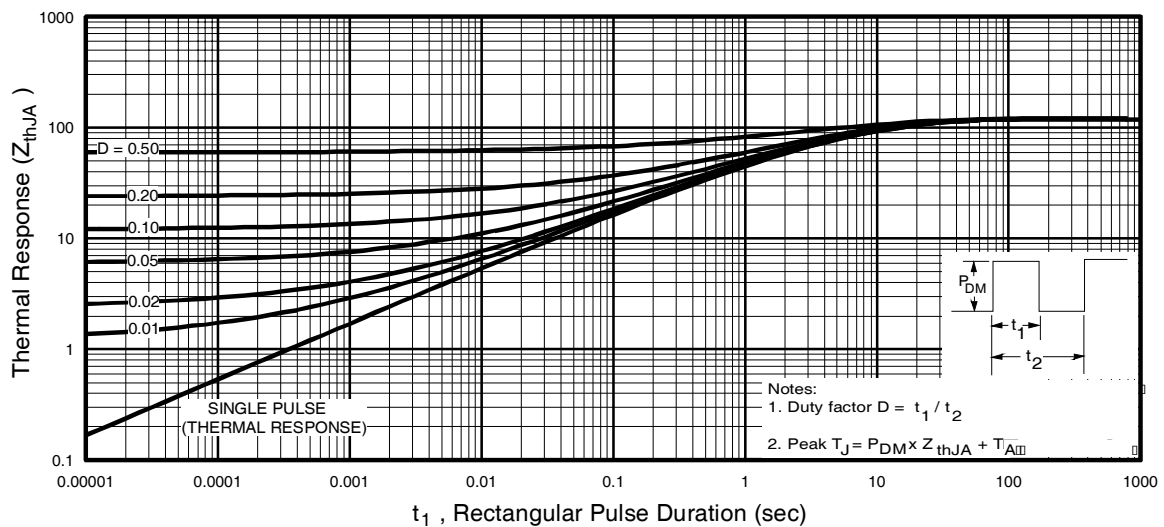

Fig 11. Maximum Effective Transient Thermal Impedance, Junction-to-Ambient

IRLL014NPbF

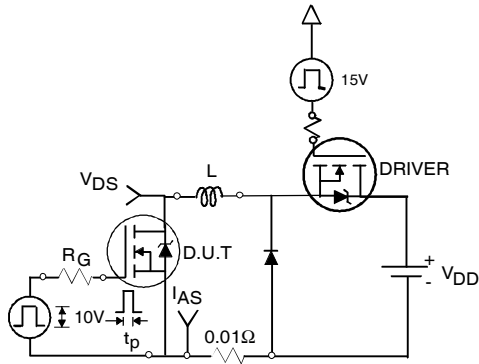

Fig 12a. Unclamped Inductive Test Circuit

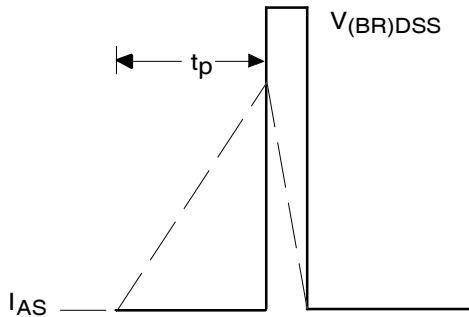

Fig 12b. Unclamped Inductive Waveforms

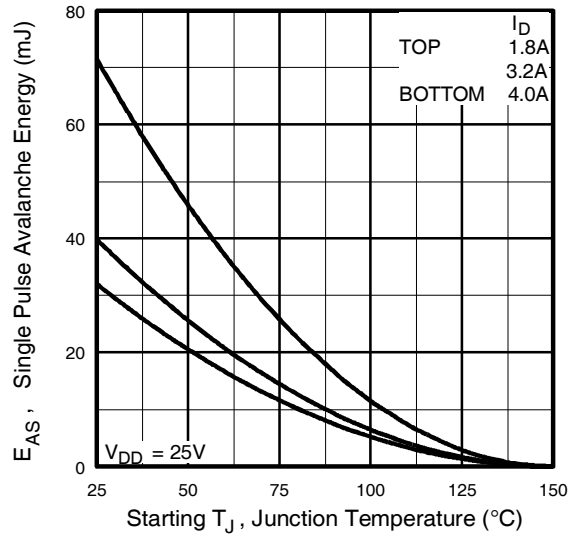
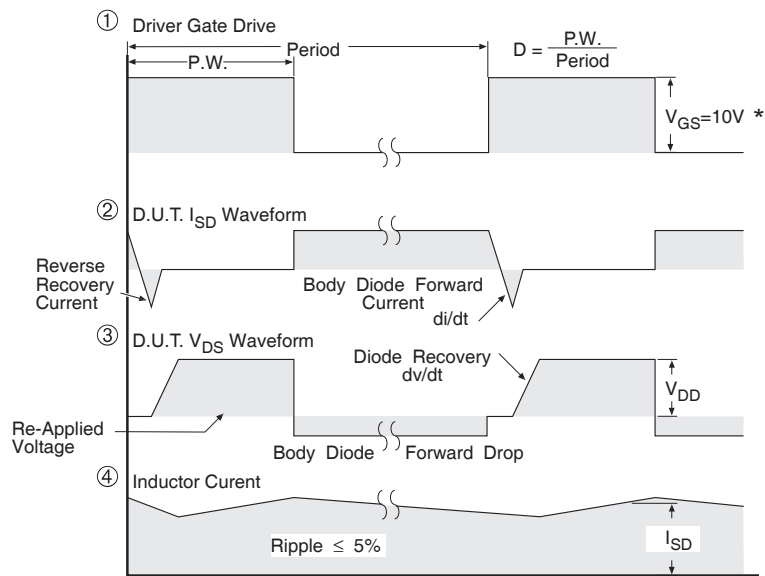
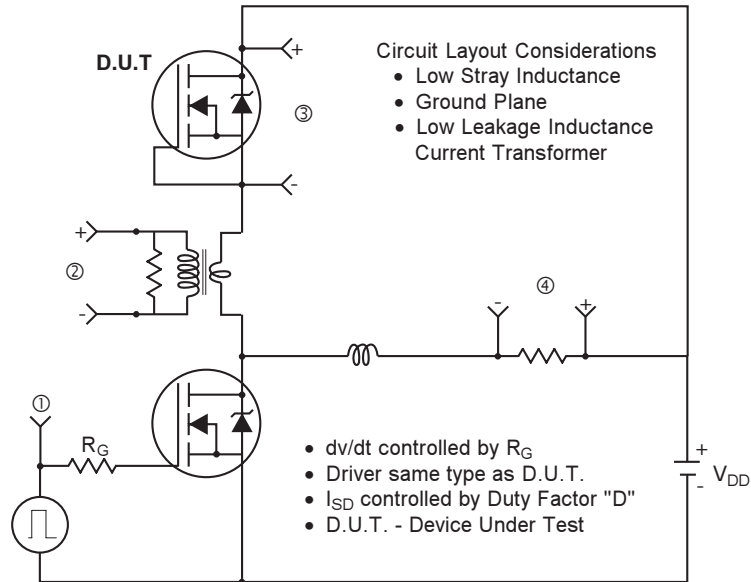

Fig 12c. Maximum Avalanche Energy Vs. Drain Current

Peak Diode Recovery dv/dt Test Circuit



* $V_{GS} = 5V$ for Logic Level Devices

Fig 13. For N-Channel HEXFETS

IRLL014NPbF

SOT-223 (TO-261AA) Package Outline

Dimensions are shown in millimeters (inches)

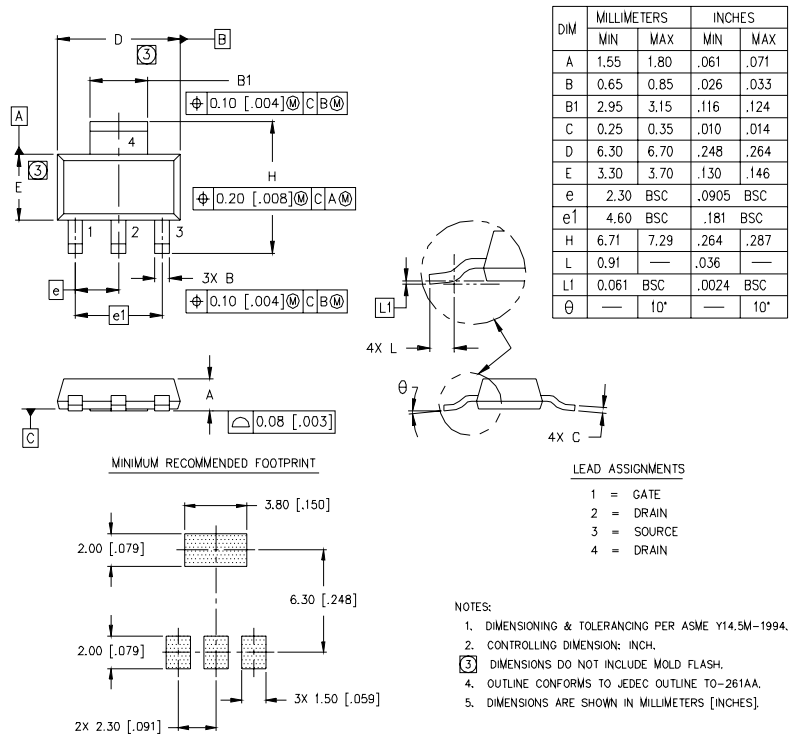

SOT-223 (TO-261AA) Part Marking Information

HEXFET PRODUCT MARKING

EXAMPLE: THIS IS AN IRFL014

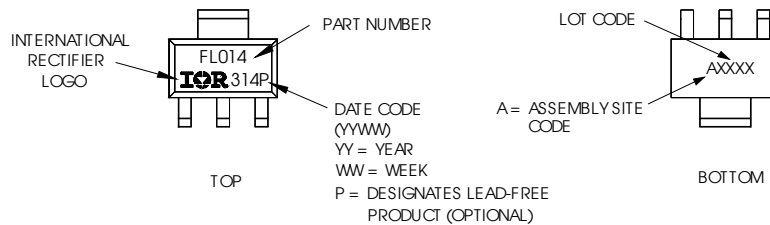

SOT-223 (TO-261AA) Tape & Reel Information

Dimensions are shown in millimeters (inches)

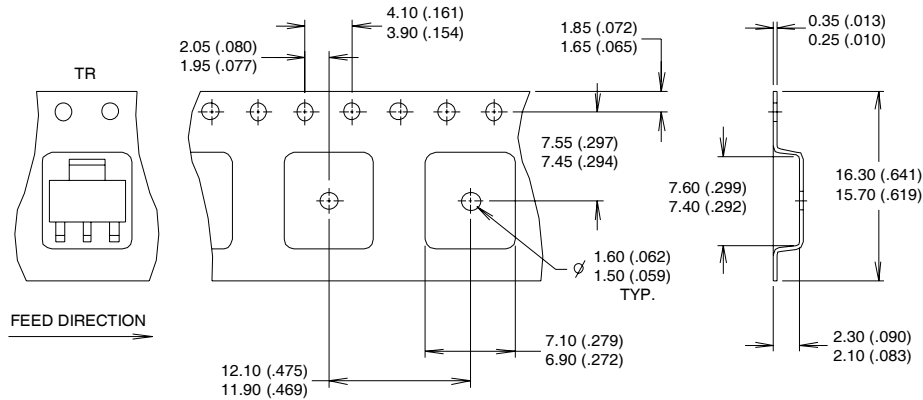

- NOTES :
1. CONTROLLING DIMENSION: MILLIMETER.
 2. OUTLINE CONFORMS TO EIA-481 & EIA-541.
 3. EACH \varnothing 330.00 (13.00) REEL CONTAINS 2,500 DEVICES.

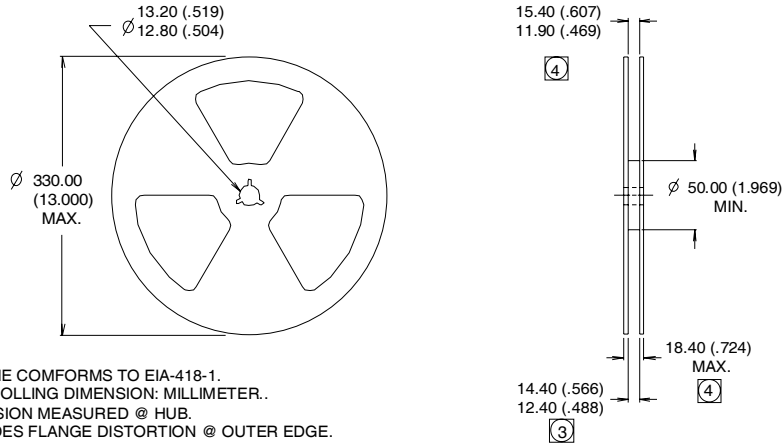

- NOTES :
1. OUTLINE COMFORMS TO EIA-418-1.
 2. CONTROLLING DIMENSION: MILLIMETER.
 - ③ DIMENSION MEASURED @ HUB.
 - ④ INCLUDES FLANGE DISTORTION @ OUTER EDGE.

Data and specifications subject to change without notice.