

IRS211(7,71,8)(S)
SINGLE CHANNEL DRIVER

IC Features

- Floating channel designed for bootstrap operation
- Fully operational to +600V
- Tolerant to negative transient voltage, dV/dt immune
- Gate drive supply range from 10 V to 20V
- Undervoltage lockout
- CMOS Schmitt-triggered inputs with pull-down
- Output in phase with input
- RoHS compliant
- IRS2117 and IRS2118 available in PDIP8

Product Summary

Topology	Single High Side	
V _{OFFSET}	600 V	
V _{OUT}	10V-20 V	
I _{O+} & I _{O-} (typical)	290 mA & 600 mA	
IN voltage threshold	IRS211(7,8)	9.5 V & 6 V
	IRS21171	2.5 V & 0.8 V

Package Type



SOIC8



PDIP8

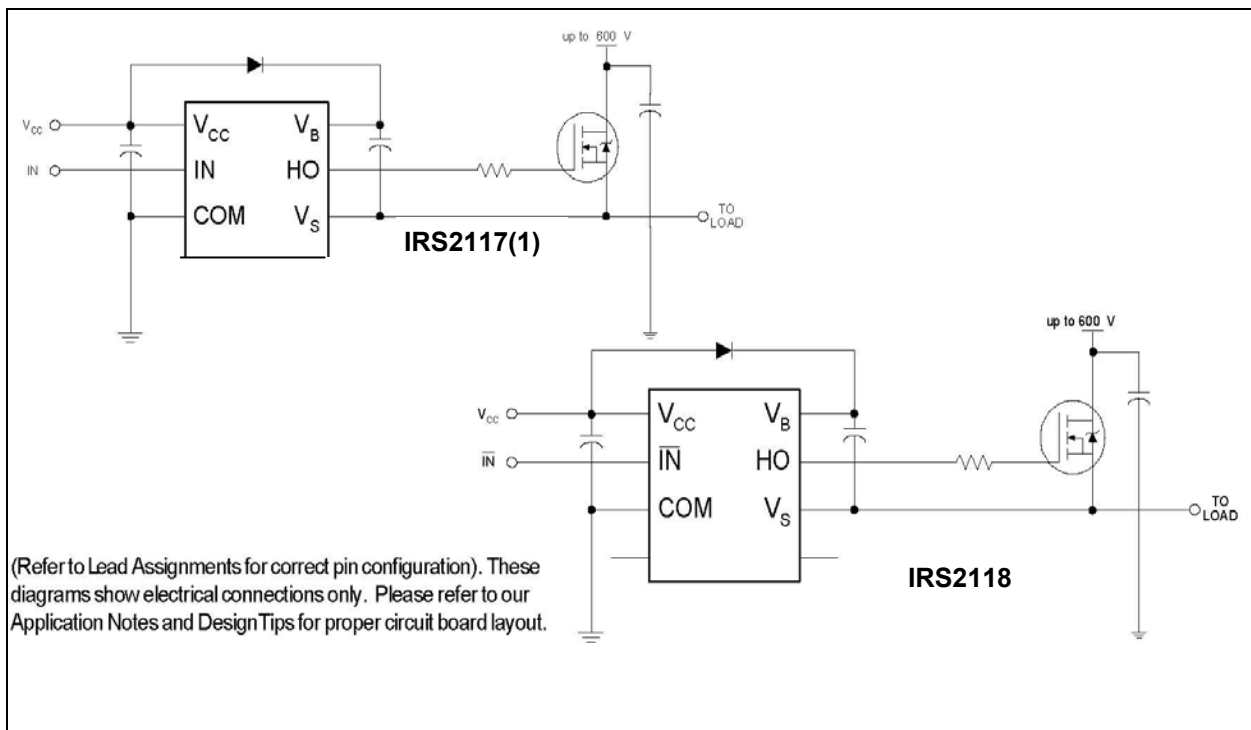

Table of Contents	Page
Description	3
Qualification Information	4
Absolute Maximum Ratings	5
Recommended Operating Conditions	5
Static Electrical Characteristics	6
Dynamic Electrical Characteristics	6
Functional Block Diagram	7
Input/Output Pin Equivalent Circuit Diagram	8
Lead Definitions	9
Lead Assignments	9
Application Information and Additional Details	10
Parameter Temperature Trends	14
Package Details	23
Tape and Reel Details	24
Part Marking Information	25
Ordering Information	26

Description

The IRS2117, IRS21171, and IRS2118 are high voltage, high speed power MOSFET and IGBT driver. Proprietary HVIC and latch immune CMOS technologies enable ruggedized mono-lithic construction. The logic input is compatible with standard CMOS outputs. The output driver features a high pulse current buffer stage designed for minimum cross-conduction. The floating channel can be used to drive an N-channel power MOSFET or IGBT in the high-side or low-side configuration which operates up to 600 V.

Qualification Information[†]

Qualification Level		Industrial ^{††} (per JEDEC JESD 47)	
		Comments: This family of ICs has passed JEDEC's Industrial qualification. IR's Consumer qualification level is granted by extension of the higher Industrial level.	
Moisture Sensitivity Level		SOIC8	MSL2 ^{†††} 260°C (per IPC/JEDEC J-STD-020C)
		PDIP8	Not applicable (non-surface mount package style)
ESD	Machine Model	Class B (per JEDEC standard EIA/JESD22-A115)	
	Human Body Model	Class 3A (per EIA/JEDEC standard JESD22-A114)	
IC Latch-Up Test		Class I, Level A (per JESD78)	
RoHS Compliant		Yes	

† Qualification standards can be found at International Rectifier's web site <http://www.irf.com/>

†† Higher qualification ratings may be available should the user have such requirements. Please contact your International Rectifier sales representative for further information.

††† Higher MSL ratings may be available for the specific package types listed here. Please contact your International Rectifier sales representative for further information.

Absolute Maximum Ratings

Absolute maximum ratings indicate sustained limits beyond which damage to the device may occur. All voltage parameters are absolute voltages referenced to COM. The thermal resistance and power dissipation ratings are measured under board mounted and still air conditions.

Symbol	Definition	Min.	Max.	Units	
VB	High-side floating supply voltage	-0.3	625	V	
VS	High-side floating supply offset voltage	VB - 25	VB + 0.3		
VHO	High-side floating output voltage	VS - 0.3	VB + 0.3		
VCC	Logic supply voltage	- 0.3	25		
VIN	Logic input voltage	- 0.3	VCC + 0.3		
dVS/dt	Allowable offset supply voltage transient (fig.2)	---	50	V/ns	
PD	Package power dissipation @ $T_A \leq +25^\circ\text{C}$	8 lead SOIC	---	0.625	W
		8 lead PDIP		1.0	
R θ JA	Thermal Resistance, junction to Ambient	8 lead SOIC	---	200	$^\circ\text{C}/\text{W}$
		8 lead PDIP		125	
TJ	Junction temperature	---	150	$^\circ\text{C}$	
TS	Storage temperature	-55	150		
TL	Lead Temperature (soldering, 10 seconds)	---	300		

Recommended Operating Conditions

The input/output logic timing diagram is shown in Fig. 1. For proper operation the device should be used within the recommended conditions. The VS offset rating is tested with all supplies biased at 15 V differential.

Symbol	Definition	Min.	Max.	Units
VB	High-Side floating supply absolute voltage	VS + 10	VS + 20	V
VS	High-side floating supply offset voltage	†	600	
VST	Transient High side floating supply offset voltage	-50 (††)	600	
VHO	High-side floating output voltage	VS	VB	
VCC	Logic supply voltage	10	20	
VIN	Logic input voltage	0	VCC	
TA	Ambient Temperature	-40	125	$^\circ\text{C}$

† Logic operational for V_S of -5 V to +600 V. Logic state held for V_S of -5 V to $-V_{BS}$.

†† Operational for transient negative VS of COM - 50 V with a 50 ns pulse width. Guaranteed by design. Refer to the Application Information section of this datasheet for more details.

Dynamic Electrical CharacteristicsV_{BIAS} (V_{CC}, V_{BS}) = 15 V, C_L = 1000 pF and T_A = 25 ° C unless otherwise specified.

Symbol	Definition	Min.	Typ.	Max.	Units	Test Conditions	
t _{on}	Turn-on propagation delay	IRS21171	---	160	230	ns	V _S = 0V
		IRS211(7,8)	---	125	200		
t _{off}	Turn-off propagation delay	IRS21171	---	160	230		V _S = 600V
		IRS211(7,8)	---	105	180		
t _r	Turn-on rise time	---	75	130			
t _f	Turn-off fall time	---	35	65			

Static Electrical CharacteristicsV_{BIAS} (V_{CC}, V_{BS}) = 15 V and T_A = 25 ° C unless otherwise specified. The V_{IN}, V_{TH}, and I_{IN} parameters are referenced to COM. The V_O and I_O parameters are referenced to COM and are applicable to the respective output leads: HO or LO.

Symbol	Definition	Min	Typ	Max	Units	Test Conditions	
V _{IH}	Input voltage –logic “1”	IRS21171	2.5	---	---	V	
		IRS211(7,8)	9.5	---	---		
V _{IL}	Input voltage – logic “0”	IRS21171	---	---	0.8		
		IRS211(7,8)			6.0		
V _{OH}	High level output voltage, V _{BIAS} – V _O	---	0.05	0.2	I _O = 2mA		
V _{OL}	Low level output voltage, V _O	---	0.02	0.1			
I _{LK}	Offset supply leakage current	---	---	50	μA	V _B = V _S = 600V	
I _{QBS}	Quiescent V _{BS} Supply Current	IRS211(7,8)	---	50		240	V _{IN} = 0V or V _{CC}
		IRS21171	---	80		150	
I _{QCC}	Quiescent V _{CC} Supply Current	IRS211(7,8)	---	70		340	
		IRS21171	---	120		240	
I _{IN+}	Logic “1” input bias current	IRS2117(1)	---	20		40	
		IRS2118				V _{IN} = 0V	
I _{IN-}	Logic “0” input bias current	IRS2117(1)	---	---	5.0	V _{IN} = V _{CC}	
		IRS2118					
V _{BSUV+}	V _{BS} supply undervoltage positive going	7.6	8.6	9.6	V		
V _{BSUV-}	V _{BS} supply undervoltage negative going	7.2	8.2	9.2			
V _{CCUV+}	V _{CC} supply undervoltage positive going	7.6	8.6	9.6			
V _{CCUV-}	V _{CC} supply undervoltage negative going	7.2	8.2	9.2			
I _{O+}	Output high short circuit pulsed current	200	290	---	mA	V _O = 0V V _{IN} Logic “1” PW ≤ 10 μs	
I _{O-}	Output low short circuit pulsed current	420	600	---		V _O = 15V V _{IN} Logic “0” PW ≤ 10 μs	

Functional Block Diagram

IRS2117(1)

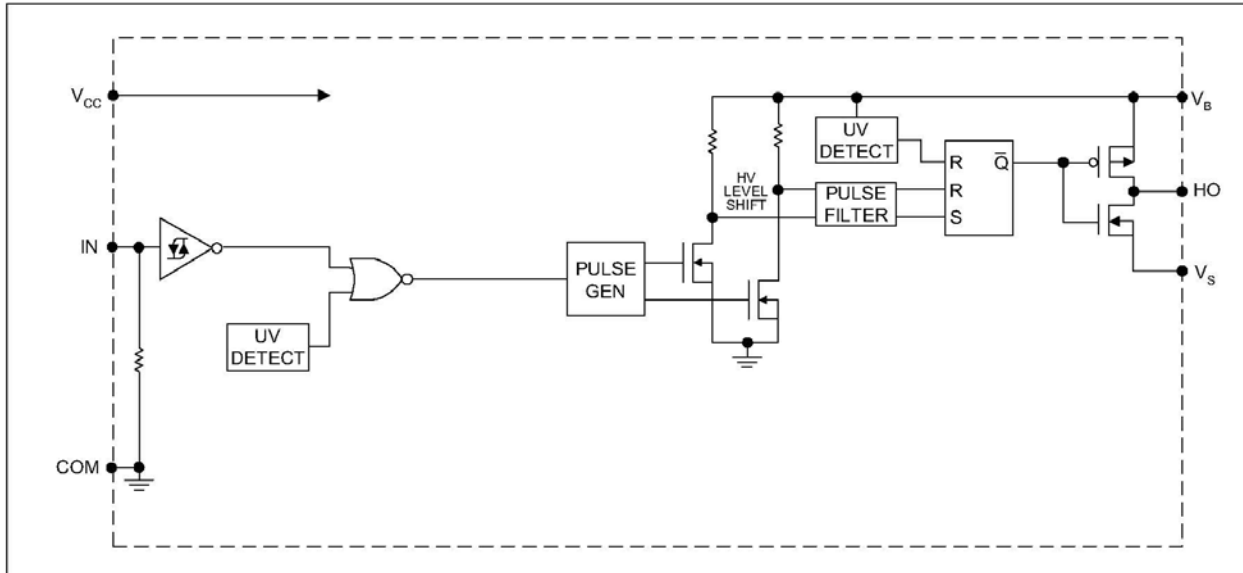

IRS2118

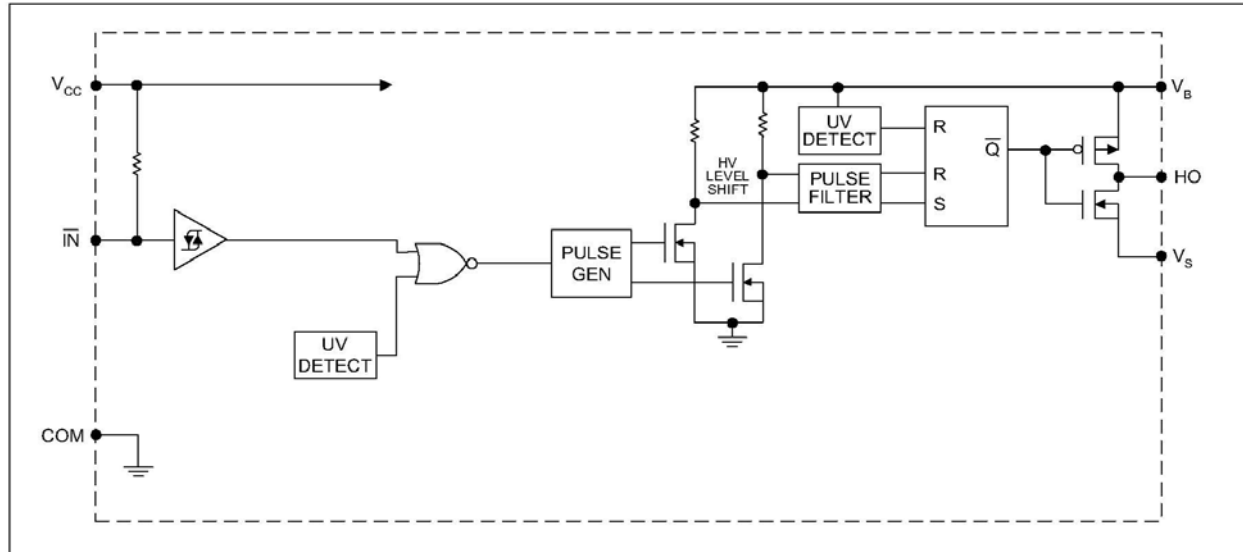

I/O Pin Equivalent Circuit Diagrams: IRS211(7,71,8)

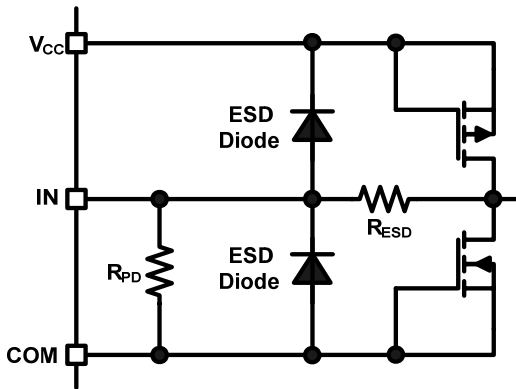
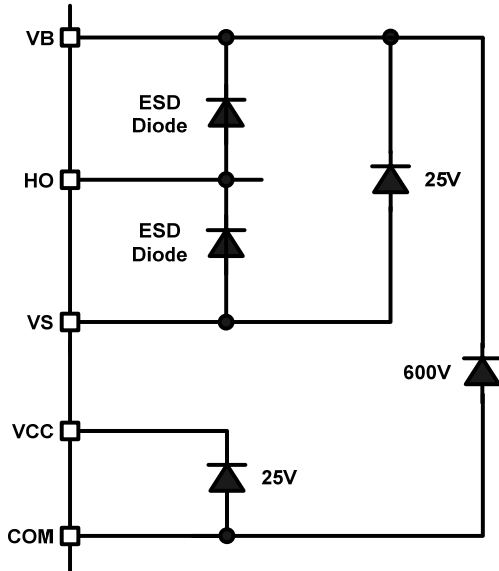

IRS2117(1)

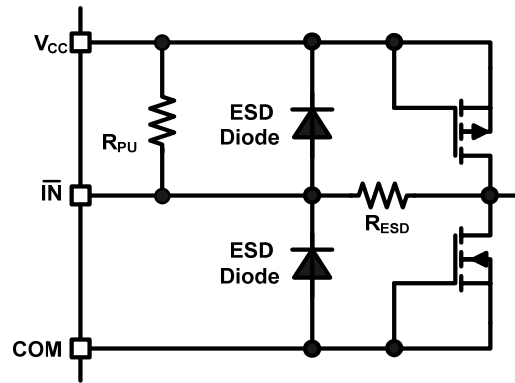

IRS2118

Lead Definitions

Pin #	Symbol	Description
1	VCC	Logic and gate drive supply
2	IN	IRS2117(1) Logic input for gate driver output (HO), in phase with HO
	$\overline{\text{IN}}$	IRS2118 Logic input for gate driver output (HO), out of phase with HO
3	NC	IRS21171 No Connect
	COM	IRS2117 / IRS2118 Logic ground
4	NC	IRS2117 / IRS2118 No Connect
	COM	IRS21171 Logic ground
5	NC	No Connect
6	V _S	High-side floating supply return
7	HO	High-side gate drive output
8	V _B	High-side floating supply

Lead Assignments

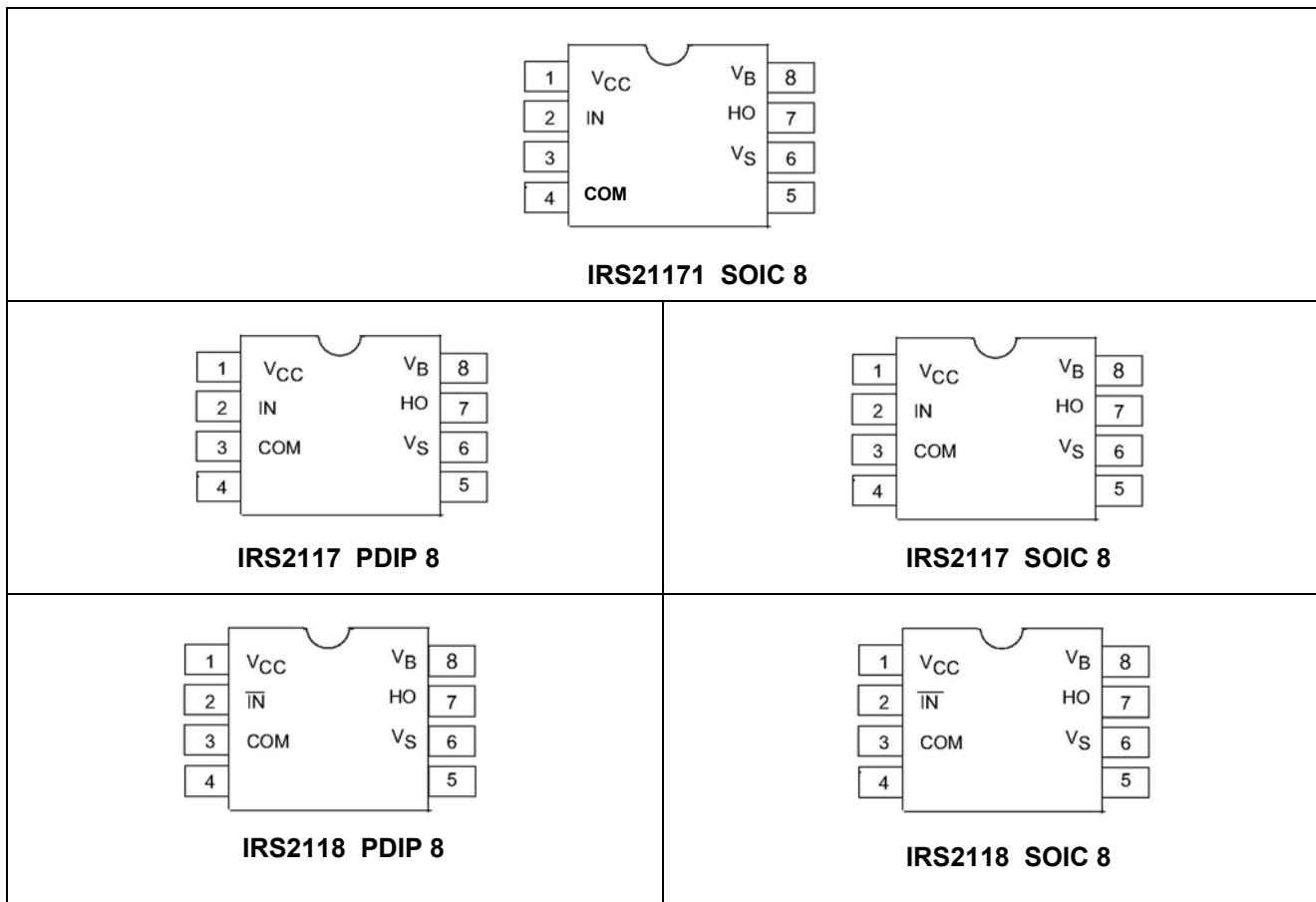

Application Information and Additional Details

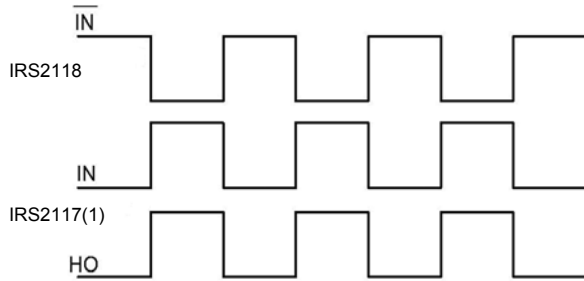

Figure 1 Input/Output Timing Diagram circuit

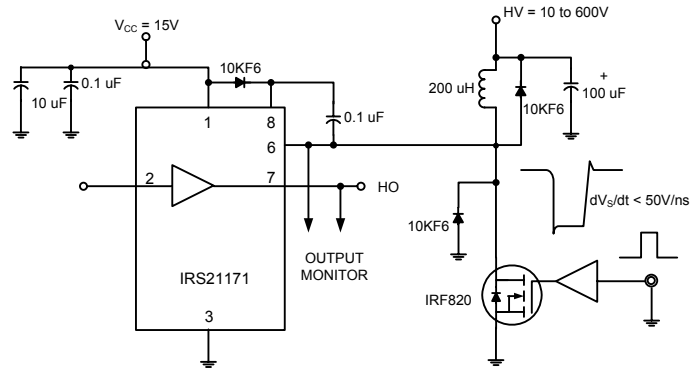

Figure 2 Floating Supply Voltage Transient Test

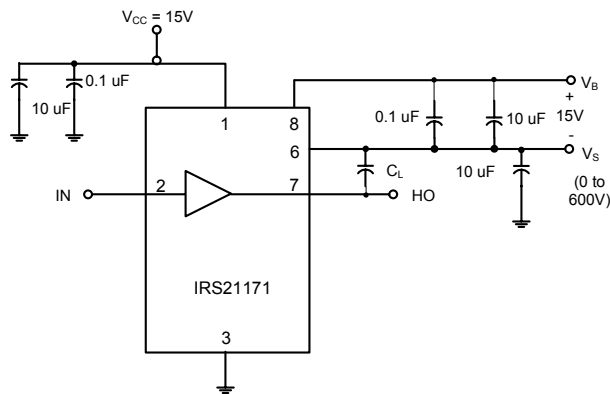

Figure 3 Switching Time Test Circuit

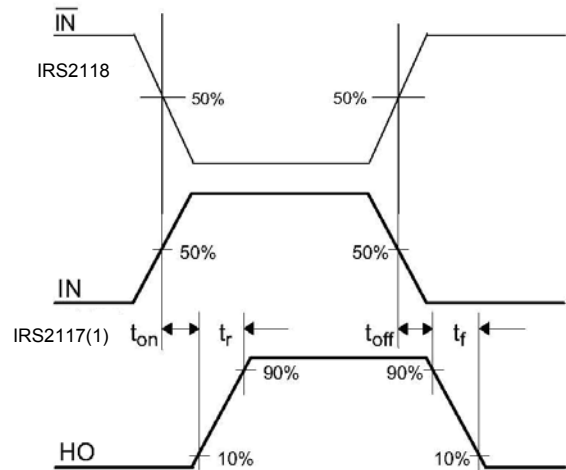

Figure 4 Switching Time Waveform Definition

Tolerant to Negative V_s Transients

A common problem in today's high-power switching converters is the transient response of the switch node's voltage as the power switches transition on and off quickly while carrying a large current. A typical half bridge circuit is shown in Figure 5; here we define the power switches and diodes of the inverter.

If the high-side switch (e.g., Q1 in Figures 6 and 7) switches off, while the current is flowing to a load, a current commutation occurs from high-side switch (Q1) to the diode (D2) in parallel with the low-side switch of the inverter. At the same instance, the voltage node V_s swings from the positive DC bus voltage to the negative DC bus voltage.

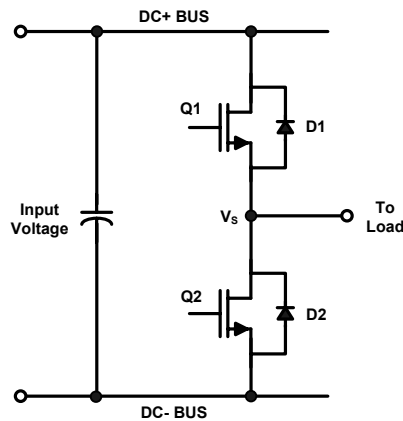

Figure 5: Half Bridge Circuit

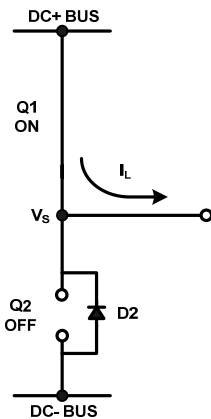

Figure 6: Q1 conducting

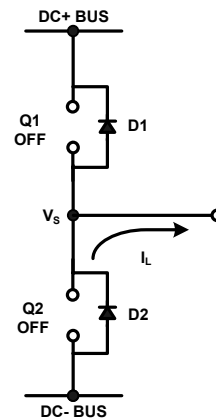

Figure 7: D2 conducting

Also when the current flows from the load back to the inverter (see Figures 8 and 9), and Q2 switches on, the current commutation occurs from D1 to Q2. At the same instance, the voltage node V_s swings from the positive DC bus voltage to the negative DC bus voltage.

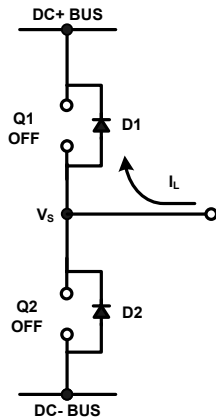

Figure 8: D1 conducting

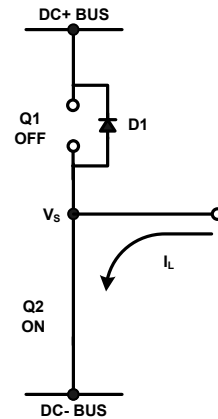

Figure 9: Q2 conducting

However, in a real inverter circuit, the V_S voltage swing does not stop at the level of the negative DC bus, rather it swings below the level of the negative DC bus. This undershoot voltage is called “negative V_S transient”.

The circuit shown in Figure 10 depicts a half bridge circuit with parasitic elements shown; Figures 11 and 12 show a simplified illustration of the commutation of the current between Q1 and D2. The parasitic inductances in the power circuit from the die bonding to the PCB tracks are lumped together in L_D and L_S for each switch. When the high-side switch is on, V_S is below the DC+ voltage by the voltage drops associated with the power switch and the parasitic elements of the circuit. When the high-side power switch turns off, the load current can momentarily flow in the low-side freewheeling diode due to the inductive load connected to V_S (the load is not shown in these figures). This current flows from the DC- bus (which is connected to the COM pin of the HVIC) to the load and a negative voltage between V_S and the DC- Bus is induced (i.e., the COM pin of the HVIC is at a higher potential than the V_S pin).

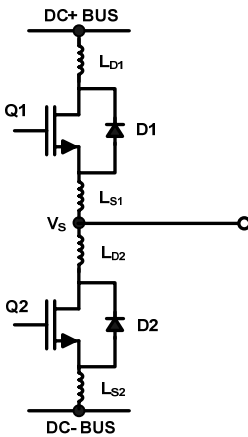

Figure 10: Parasitic Elements

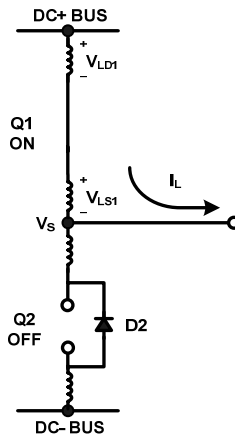

Figure 11: V_S positive

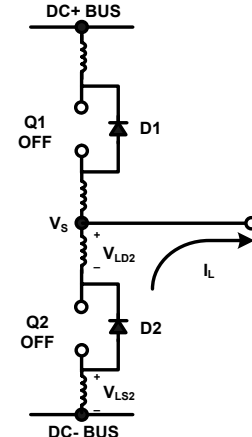

Figure 12: V_S negative

In a typical power circuit, dV/dt is typically designed to be in the range of 1-5 V/ns. The negative V_S transient voltage can exceed this range during some events such as short circuit and over-current shutdown, when di/dt is greater than in normal operation.

International Rectifier’s HVICs have been designed for the robustness required in many of today’s demanding applications. An indication of the IRS211(7,71,8)’s robustness can be seen in Figure 13, where there is represented the IRS211(7,71,8) Safe Operating Area at $V_{BS}=15V$ based on repetitive negative V_S spikes. A negative V_S transient voltage falling in the grey area (outside SOA) may lead to IC permanent damage; viceversa unwanted functional anomalies or permanent damage to the IC do not appear if negative V_S transients fall inside SOA.

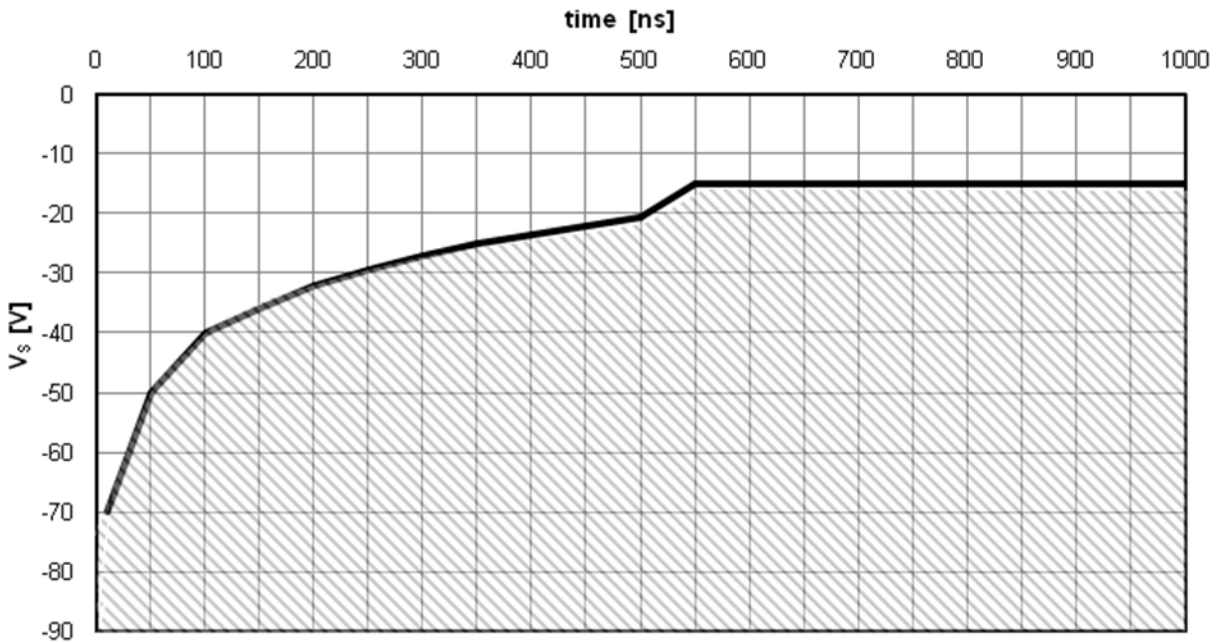
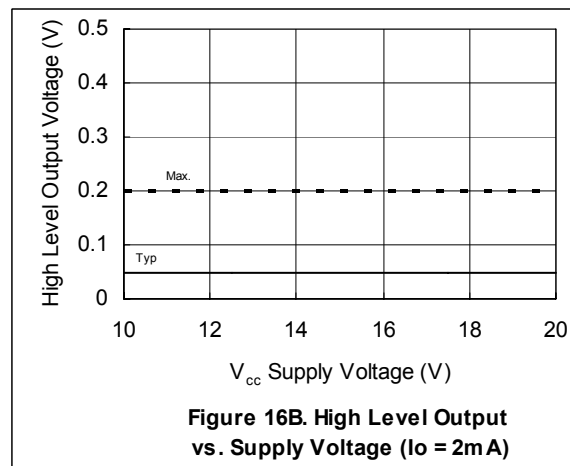
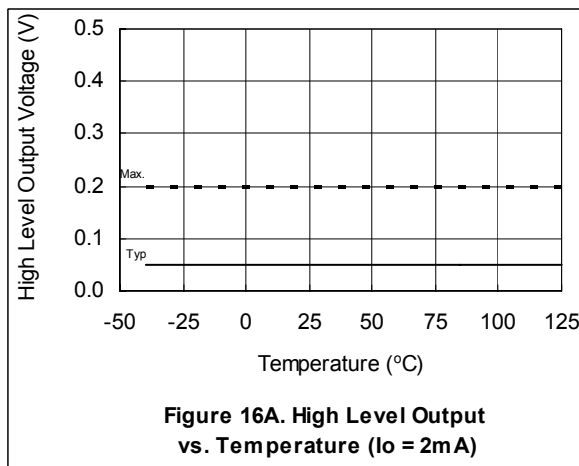
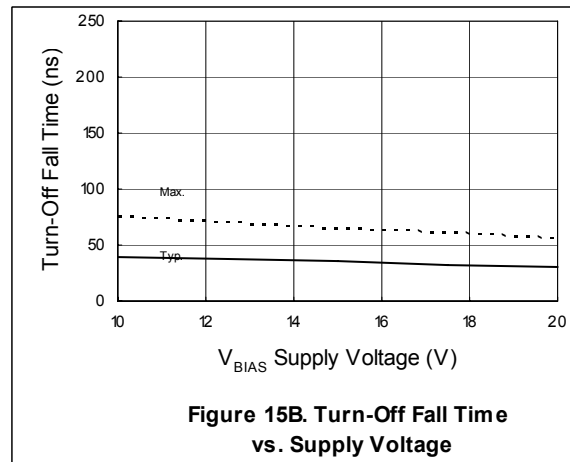
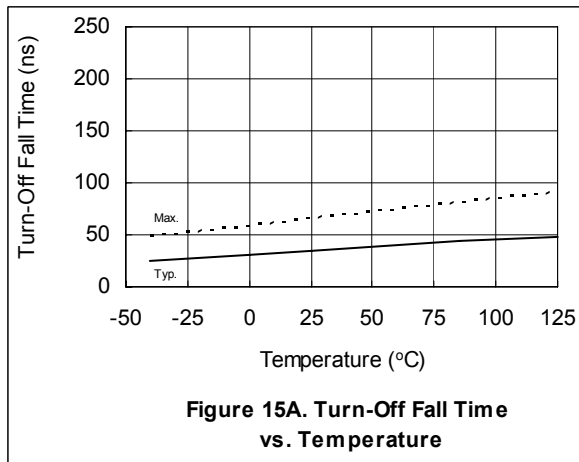
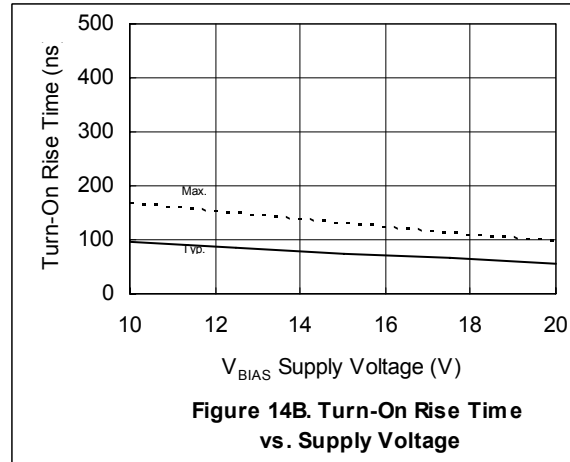
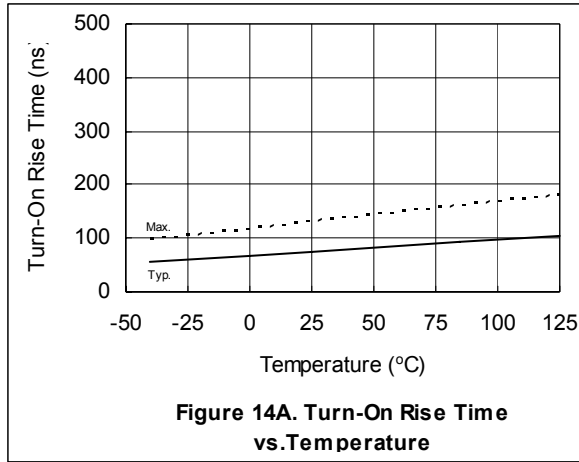
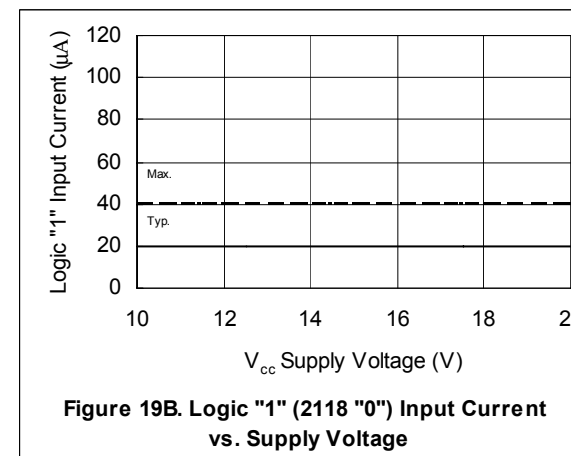
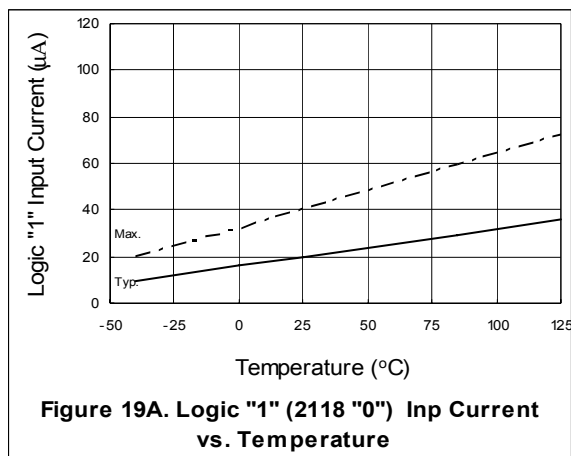
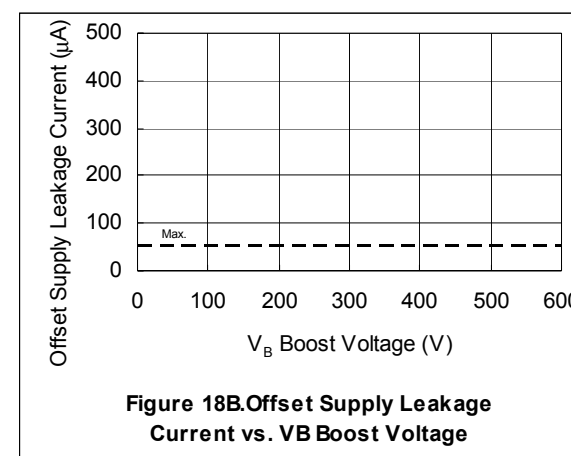
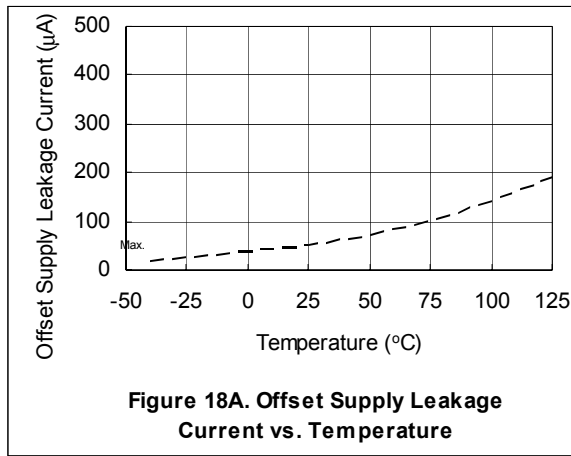
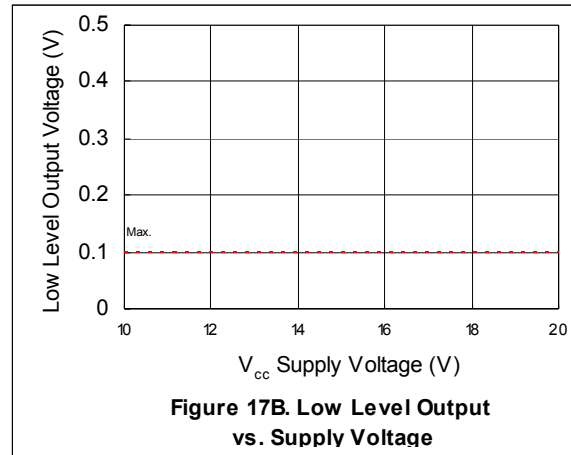
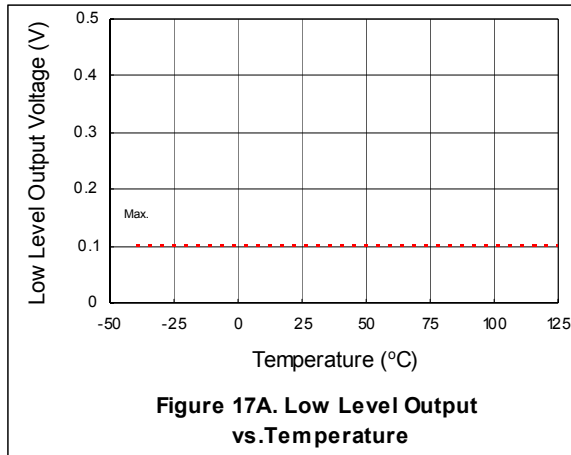

Figure 13: Negative V_s transient SOA for IRS211(7,71,8) @ $V_{BS}=15V$

Even though the IRS211(7,71,8) has shown the ability to handle these large negative V_s transient conditions, it is highly recommended that the circuit designer always limit the negative V_s transients as much as possible by careful PCB layout and component use.

Parameter Temperature Trends - 211(7,71,8)





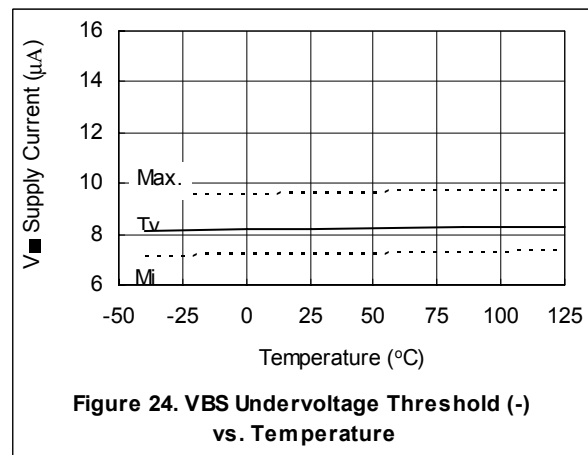
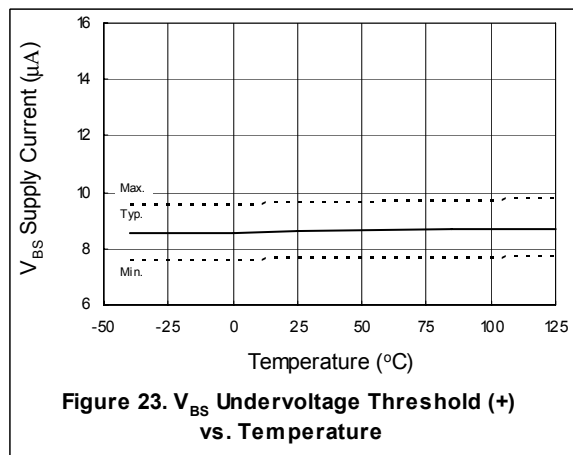
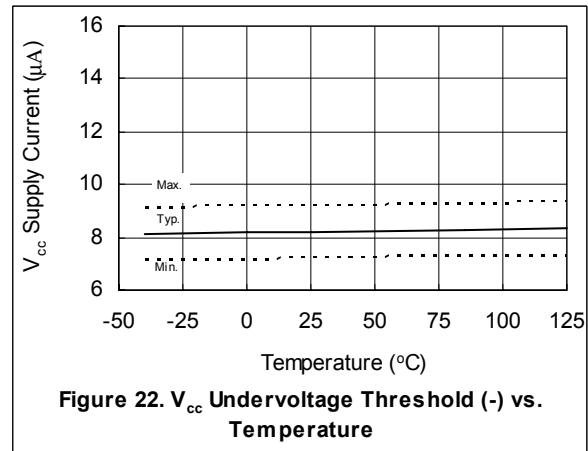
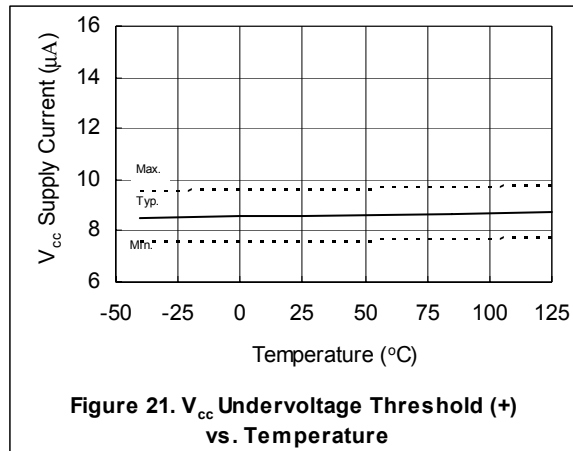
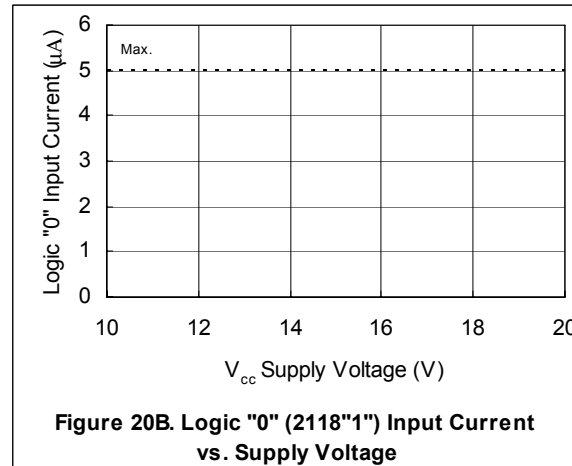
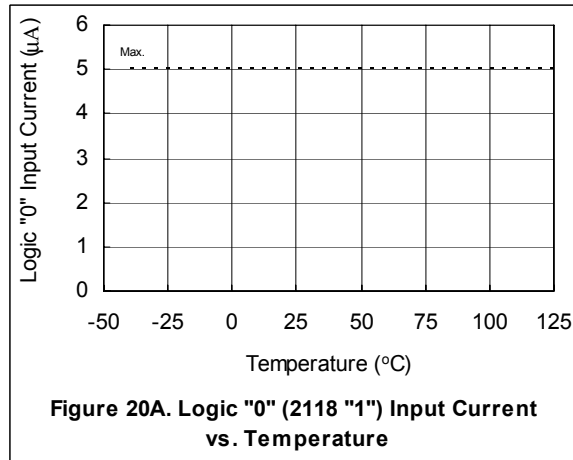

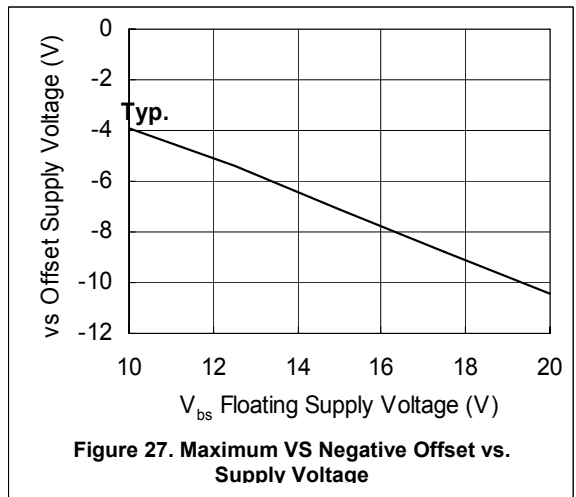
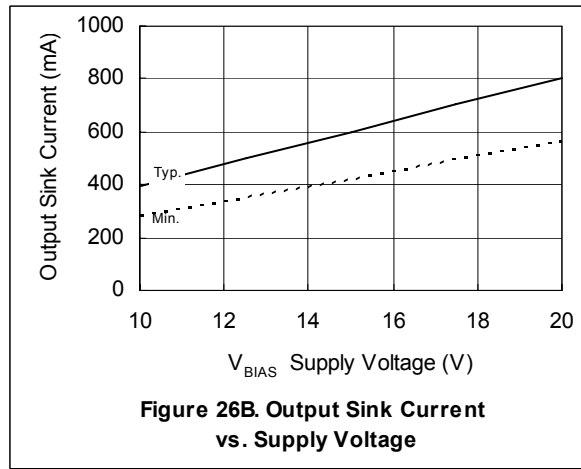
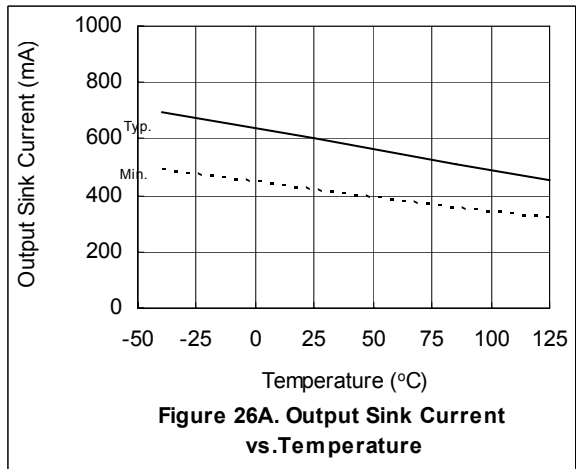
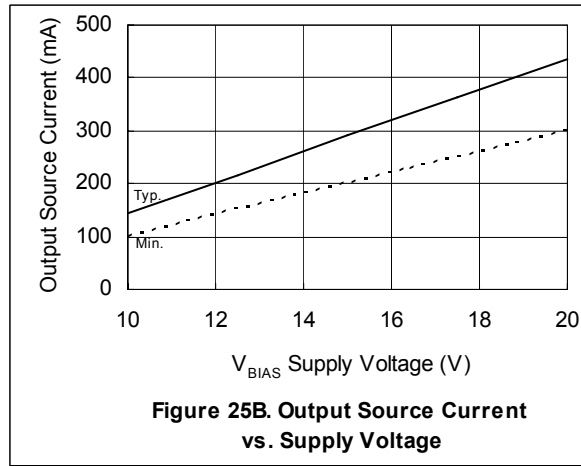
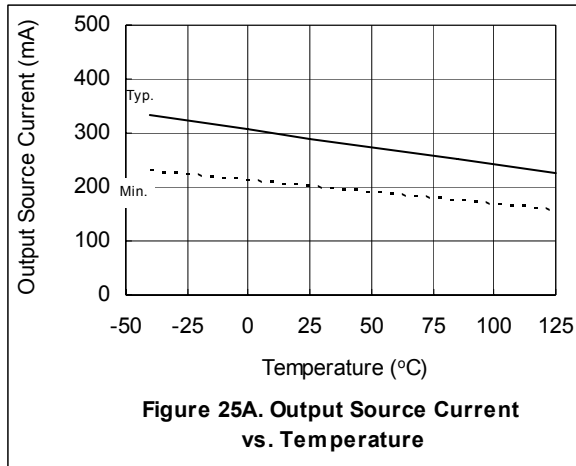

Parameter Temperature Trends - 211(7,8)

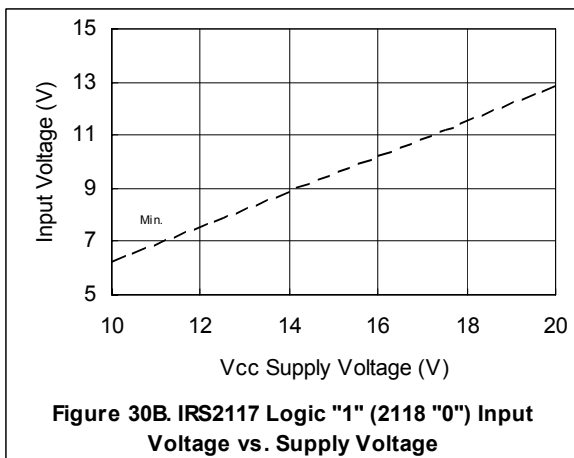
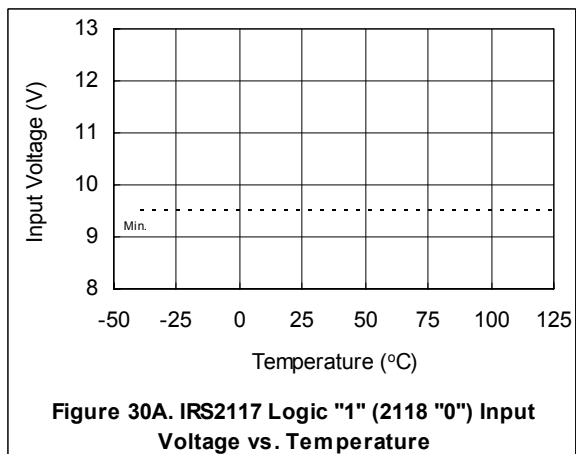
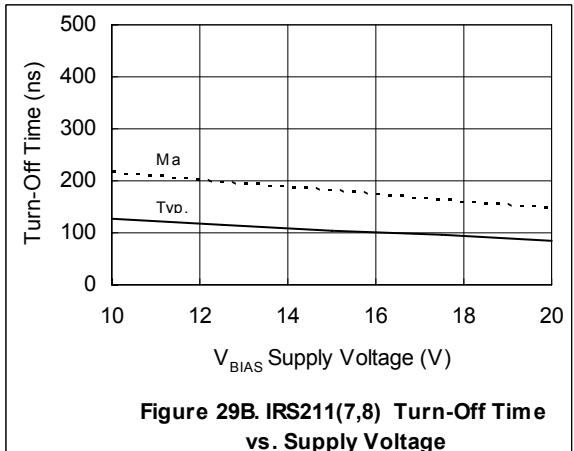
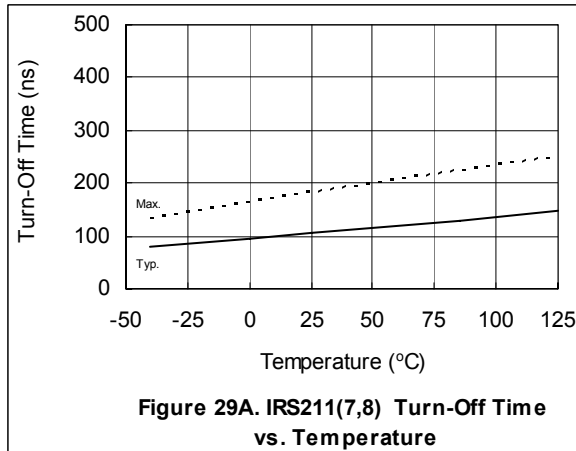
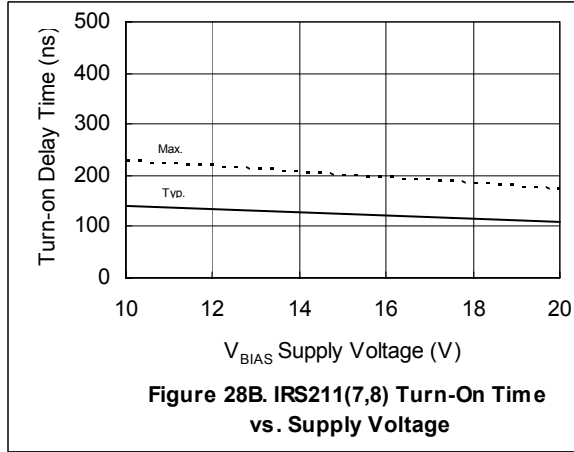
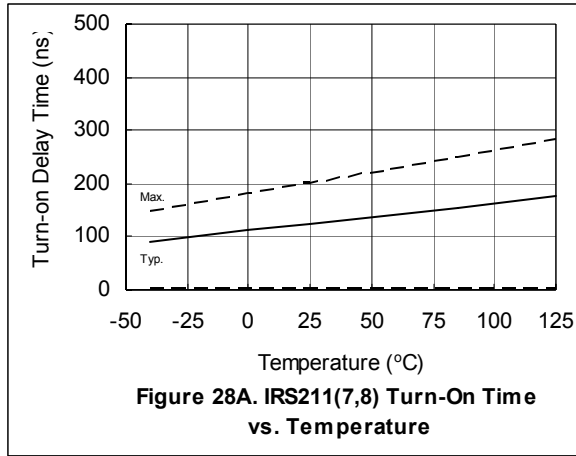

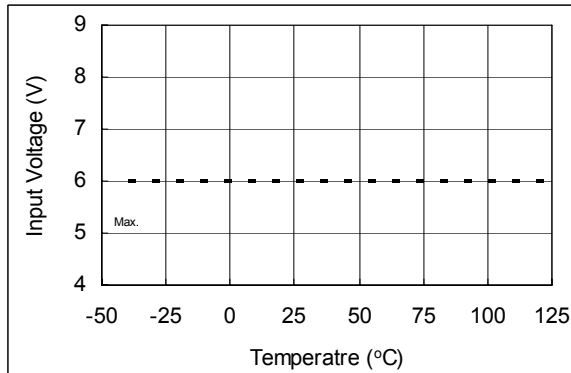

Figure 31A. IRS2117 Logic "0" (2118 "1") Input Voltage vs. Temperature

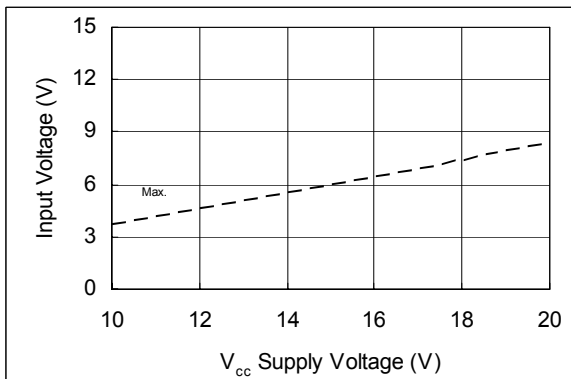

Figure 31B. IRS2117 Logic "0" (2118 "1") Input Voltage vs. Supply Voltage

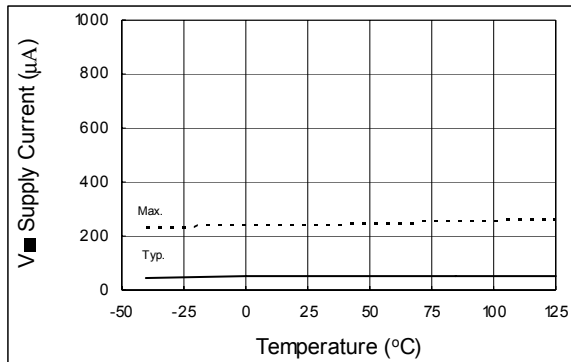

Figure 32A. 211(7,8) V_{BS} Supply Current vs. Temperature

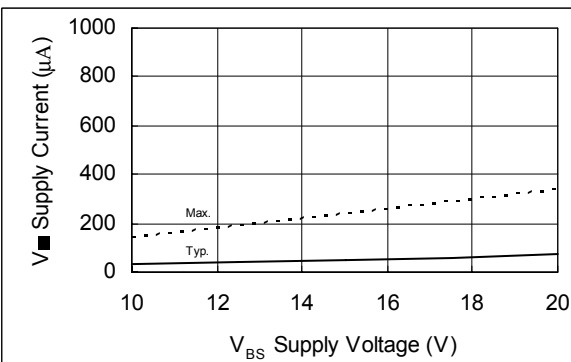

Figure 32B. 211(7,8) V_{BS} Supply Current

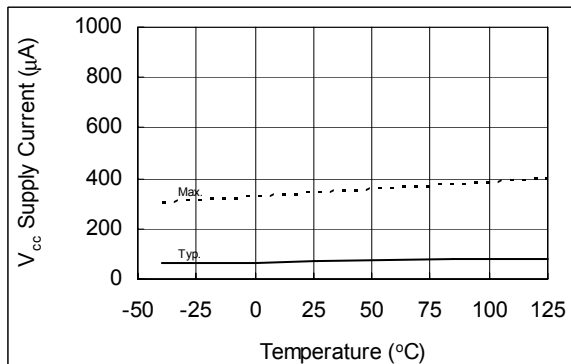

Figure 33A. 211(7,8) V_{cc} Supply Current vs. Temperature

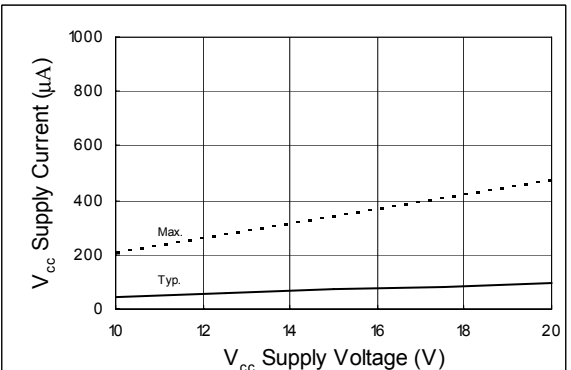

Figure 33B. 211(7,8) V_{cc} Supply Current vs. Supply Voltage

Parameter Temperature Trends - 21171

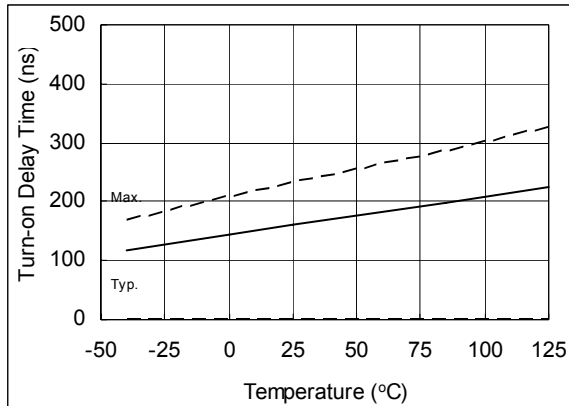

Figure 34A. IRS21171 Turn-On Time vs. Temperature

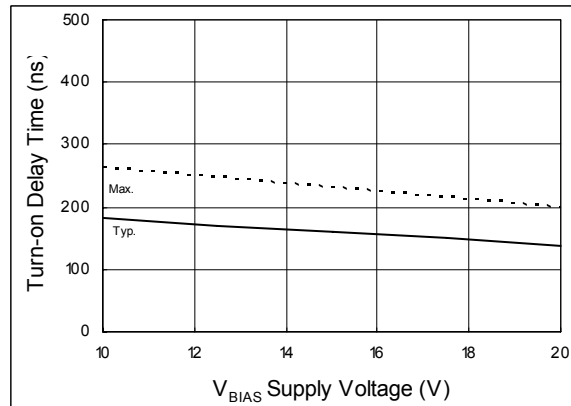

Figure 34B. IRS21171 Turn-On Time vs. Supply Voltage

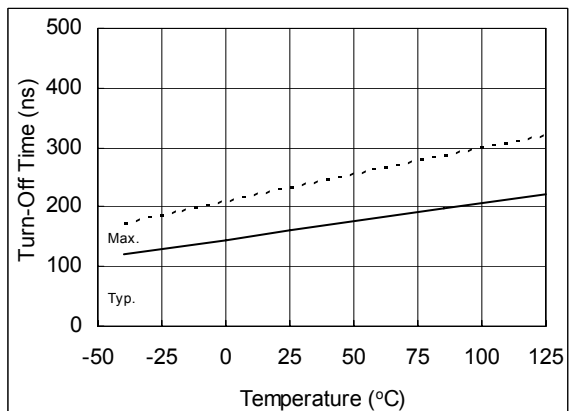

Figure 35A. IRS21171 Turn-Off Time vs. Temperature

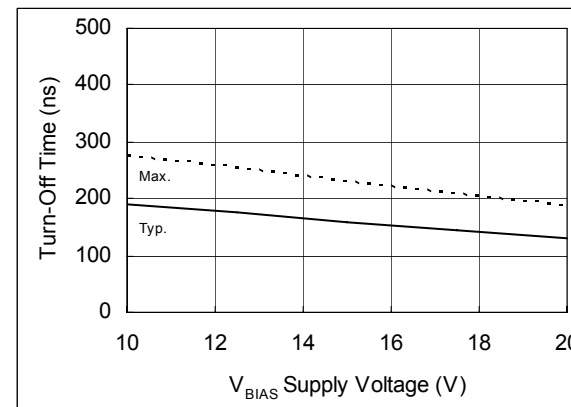

Figure 35B. IRS21171 Turn-Off Time vs. Supply Voltage

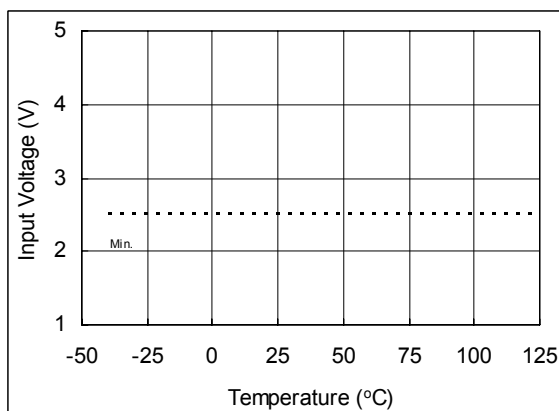

Figure 36A. IRS21171 Logic "1" Input Voltage vs. Temperature

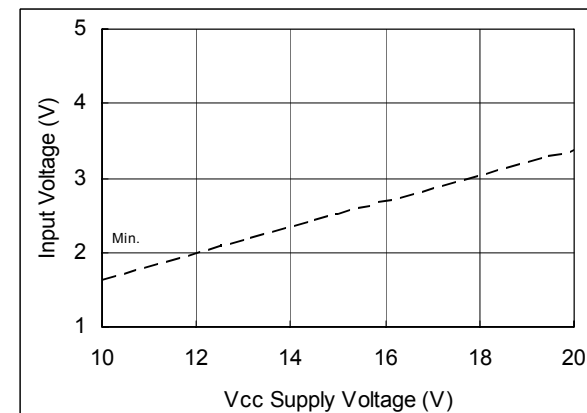
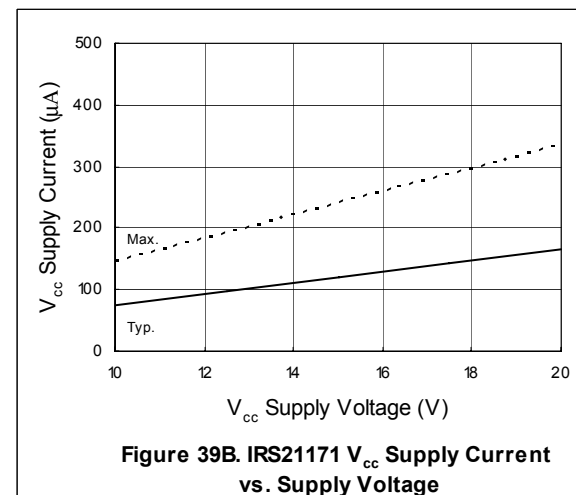
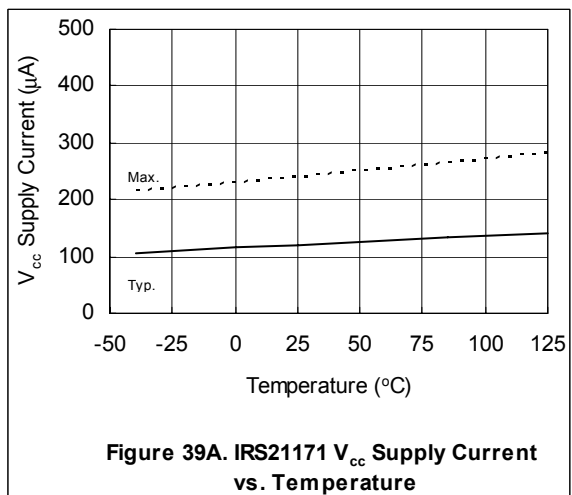
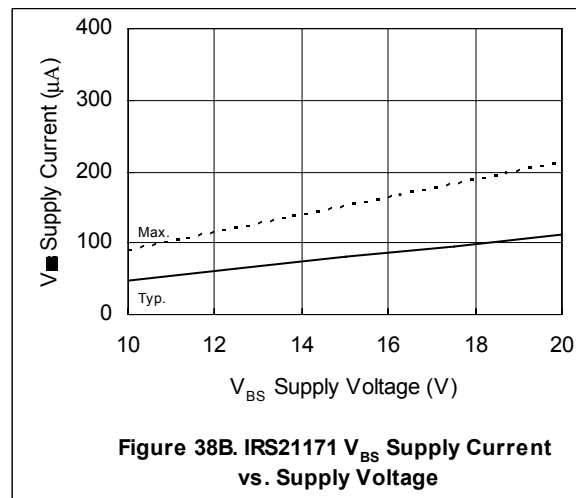
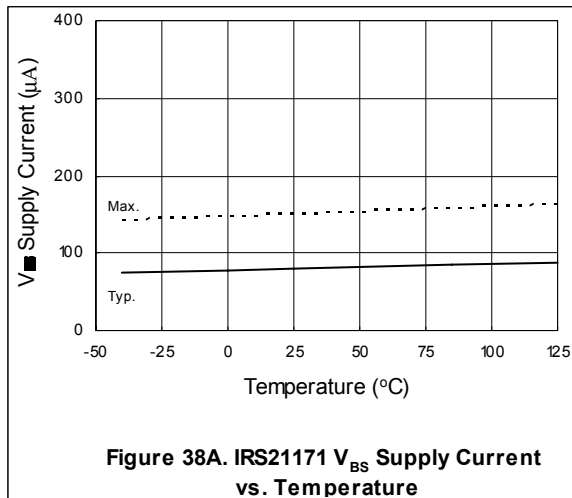
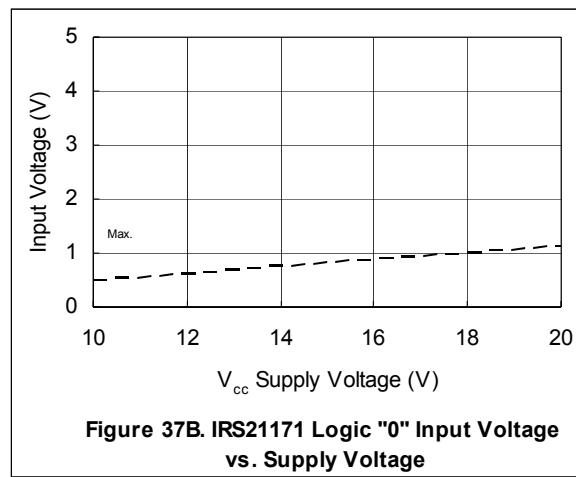
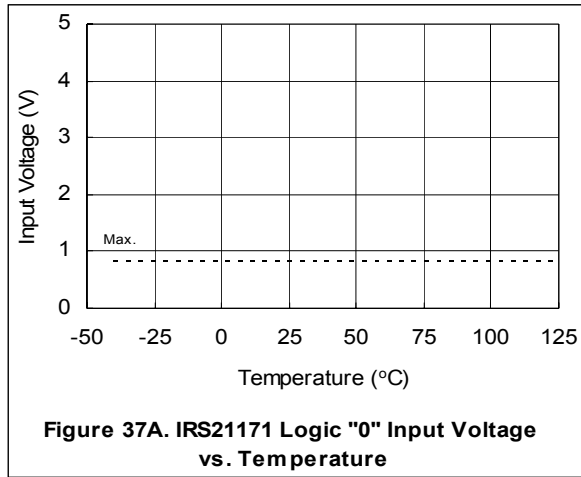

Figure 36B. IRS21171 Logic "1" Input Voltage vs. Supply Voltage



IRS211(7,71,8)(S)

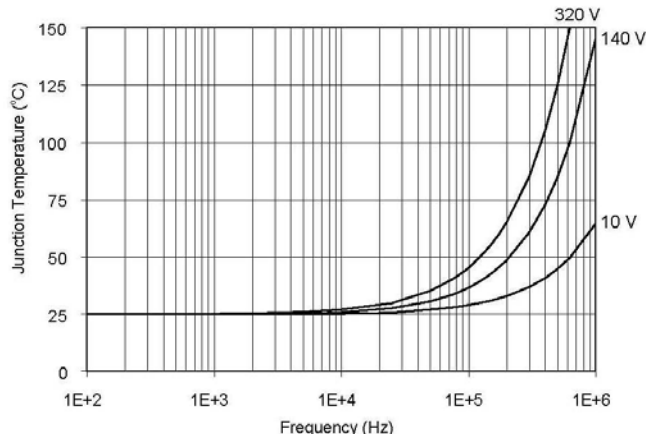

Figure 40. IRS2117/IRS2118 T_J vs. Frequency (IRFBC20)
 $R_{GATE}=33\Omega$, $V_{CC}=15V$

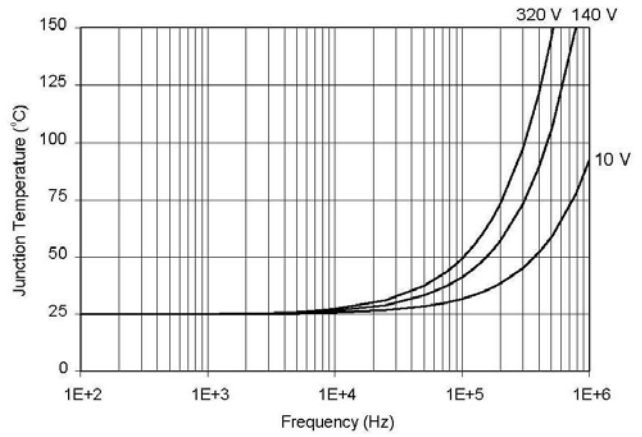

Figure 41. IRS2117/IRS2118 T_J vs. Frequency (IRFBC30)
 $R_{GATE}=22\Omega$, $V_{CC}=15V$

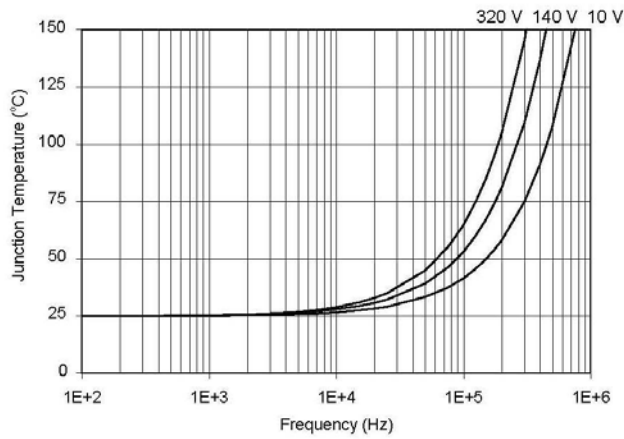

Figure 42. IRS2117/IRS2118 T_J vs. Frequency (IRFBC40)
 $R_{GATE}=15\Omega$, $V_{CC}=15V$

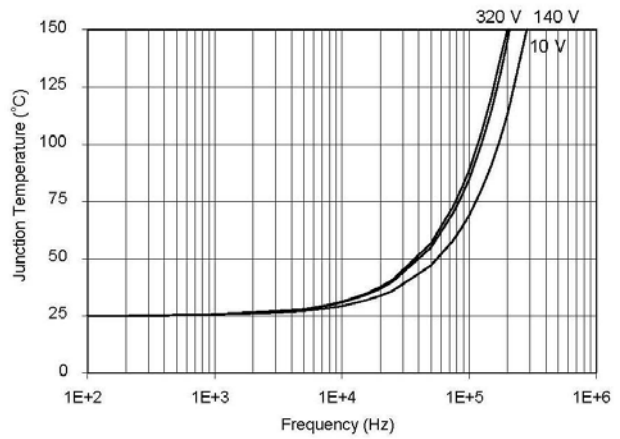

Figure 43. IRS2117/IRS2118 T_J vs. Frequency (IRFPE50)
 $R_{GATE}=10\Omega$, $V_{CC}=15V$

Package Details

NOTES:

1. DIMENSIONING & TOLERANCING PER ANSI Y14.5M-1982.
2. CONTROLLING DIMENSION: INCH.
3. DIMENSIONS ARE SHOWN IN MILLIMETERS [INCHES].
4. OUTLINE CONFORMS TO JEDEC OUTLINE MS-001AB.
- 5 MEASURED WITH THE LEADS CONSTRAINED TO BE PERPENDICULAR TO DATUM PLANE C.
- 6 DIMENSION DOES NOT INCLUDE MOLD PROTUSIONS. MOLD PROTUSIONS SHALL NOT EXCEED 0.25 [.010].

01-6014
01-3003 01 (MS-001AB)

8 Lead PDIP

DIM	INCHES		MILLIMETERS	
	MIN	MAX	MIN	MAX
A	.0532	.0688	1.35	1.75
A1	.0040	.0098	0.10	0.25
b	.013	.020	0.33	0.51
c	.0075	.0098	0.19	0.25
D	.189	.1968	4.80	5.00
E	.1497	.1574	3.80	4.00
e	.050 BASIC		1.27 BASIC	
e1	.025 BASIC		0.635 BASIC	
H	.2284	.2440	5.80	6.20
K	.0099	.0196	0.25	0.50
L	.016	.050	0.40	1.27
y	0°	8°	0°	8°

NOTES:

1. DIMENSIONING & TOLERANCING PER ASME Y14.5M-1994.
2. CONTROLLING DIMENSION: MILLIMETER
3. DIMENSIONS ARE SHOWN IN MILLIMETERS [INCHES].
4. OUTLINE CONFORMS TO JEDEC OUTLINE MS-012AA.
- 5 DIMENSION DOES NOT INCLUDE MOLD PROTUSIONS. MOLD PROTUSIONS NOT TO EXCEED 0.15 [.006].
- 6 DIMENSION DOES NOT INCLUDE MOLD PROTUSIONS. MOLD PROTUSIONS NOT TO EXCEED 0.25 [.010].
- 7 DIMENSION IS THE LENGTH OF LEAD FOR SOLDERING TO A SUBSTRATE.

01-6027
01-0021 11 (MS-012AA)

8 Lead SOIC

Package Details: SOIC8N, Tape and Reel

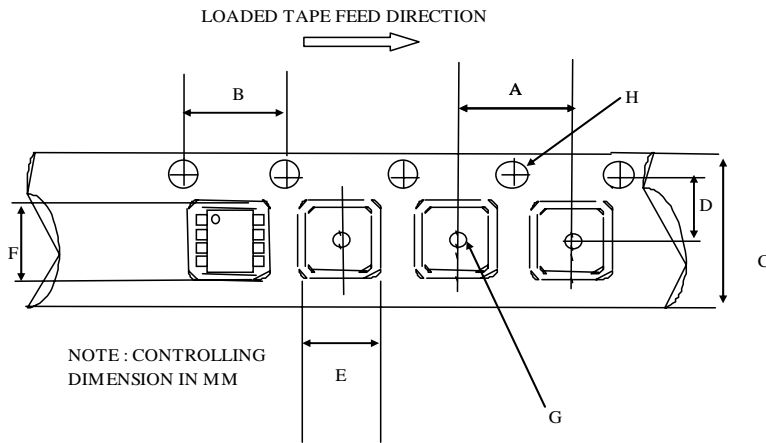

CARRIER TAPE DIMENSION FOR 8SOICN

Code	Metric		Imperial	
	Min	Max	Min	Max
A	7.90	8.10	0.311	0.318
B	3.90	4.10	0.153	0.161
C	11.70	12.30	0.46	0.484
D	5.45	5.55	0.214	0.218
E	6.30	6.50	0.248	0.255
F	5.10	5.30	0.200	0.208
G	1.50	n/a	0.059	n/a
H	1.50	1.60	0.059	0.062

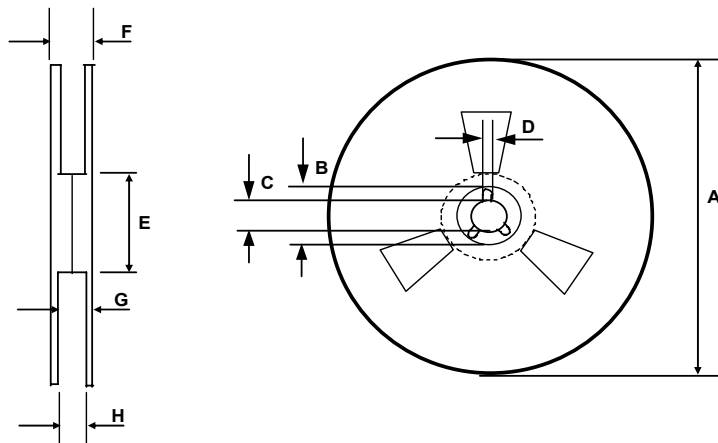

REEL DIMENSIONS FOR 8SOICN

Code	Metric		Imperial	
	Min	Max	Min	Max
A	329.60	330.25	12.976	13.001
B	20.95	21.45	0.824	0.844
C	12.80	13.20	0.503	0.519
D	1.95	2.45	0.767	0.096
E	98.00	102.00	3.858	4.015
F	n/a	18.40	n/a	0.724
G	14.50	17.10	0.570	0.673
H	12.40	14.40	0.488	0.566

Part Marking Information

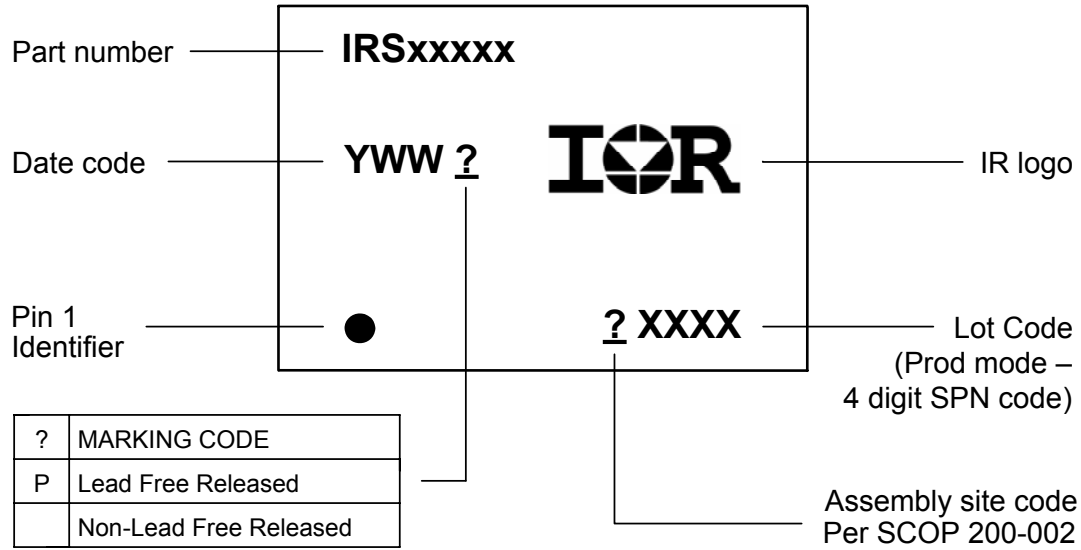

Ordering Information

Base Part Number	Package Type	Standard Pack		Complete Part Number
		Form	Quantity	
IRS2117	SOIC8N	Tube/Bulk	95	IRS2117SPBF
		Tape and Reel	2500	IRS2117STRPBF
	PDIP8	Tube/Bulk	50	IRS2117PBF
IRS21171	SOIC8N	Tube/Bulk	95	IRS21171SPBF
		Tape and Reel	2500	IRS21171STRPBF
IRS2118	SOIC8N	Tube/Bulk	95	IRS2118SPBF
		Tape and Reel	2500	IRS2118STRPBF
	PDIP8	Tube/Bulk	50	IRS2118PBF

The information provided in this document is believed to be accurate and reliable. However, International Rectifier assumes no responsibility for the consequences of the use of this information. International Rectifier assumes no responsibility for any infringement of patents or of other rights of third parties which may result from the use of this information. No license is granted by implication or otherwise under any patent or patent rights of International Rectifier. The specifications mentioned in this document are subject to change without notice. This document supersedes and replaces all information previously supplied.

For technical support, please contact IR's Technical Assistance Center
<http://www.irf.com/technical-info/>

WORLD HEADQUARTERS:
 233 Kansas St., El Segundo, California 90245
 Tel: (310) 252-7105