

IS201, IS202, IS203, IS204,
 ISD201, ISD202, ISD203, ISD204,
 ISQ201, ISQ202, ISQ203, ISQ204



**HIGH DENSITY
 PHOTOTRANSISTOR OPTICALLY
 COUPLED ISOLATORS**

APPROVALS

- UL recognised, File No. E91231

'X' SPECIFICATION APPROVALS

- VDE 0884 in 3 available lead form :-
 - STD
 - G form
 - SMD approved to CECC 00802
- IS20* Certified to EN60950 by the following Test Bodies :-
 - Nemko - Certificate No. P01102464
 - Fimko - Certificate No. FI18166
 - Semko - Reference No. 0202037/01-22
 - Demko - Certificate No. 311158-01
- BSI approved - Certificate No. 8001

DESCRIPTION

The IS20*, ISD20*, ISQ20* series of optically coupled isolators consist of infrared light emitting diodes and NPN silicon photo transistors in space efficient dual in line plastic packages.

FEATURES

- Options :-
 - 10mm lead spread - add G after part no.
 - Surface mount - add SM after part no.
 - Tape&reel - add SMT&R after part no.
- High Isolation Voltage (5.3kV_{RMS}, 7.5kV_{PK})
- High BV_{CEO} (70V min)
- All electrical parameter 100% tested
- Custom electrical selections available

APPLICATIONS

- Computer terminals
- Industrial systems controllers
- Signal transmission between systems of different potentials and impedances

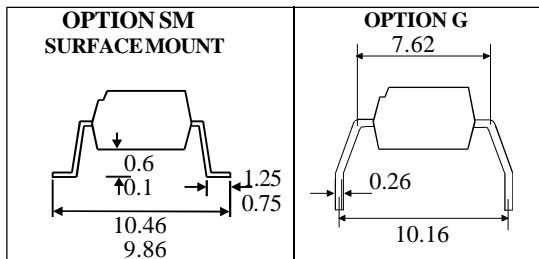

IS201
 IS202
 IS203
 IS204

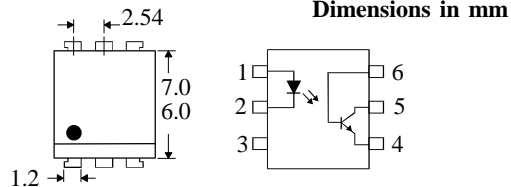

ISD201
 ISD202
 ISD203
 ISD204

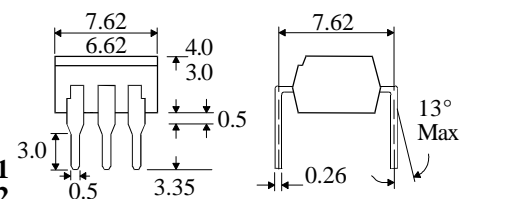

ISQ201
 ISQ202
 ISQ203
 ISQ204

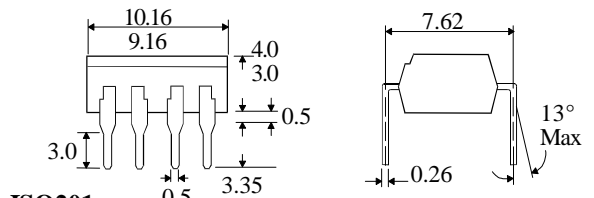
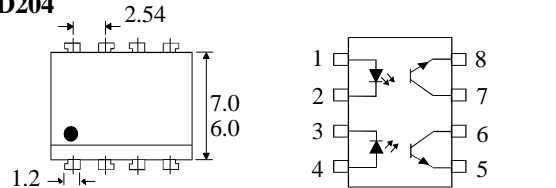

ISQ201
 ISQ202
 ISQ203
 ISQ204

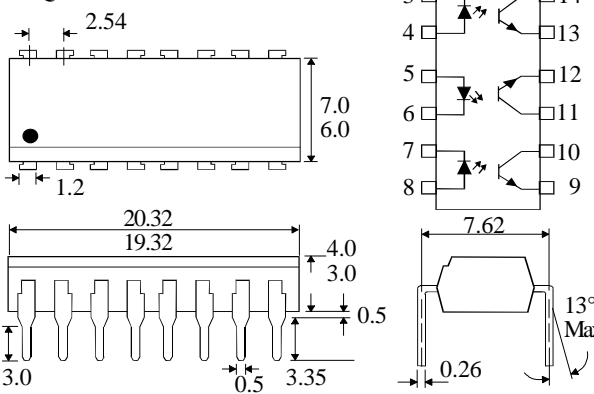

ISOCOM COMPONENTS LTD
 Unit 25B, Park View Road West,
 Park View Industrial Estate, Brenda Road
 Hartlepool, Cleveland, TS25 1YD
 Tel: (01429) 863609 Fax :(01429) 863581

ISOCOM INC
 1024 S. Greenville Ave, Suite 240,
 Allen, TX 75002 USA
 Tel: (214) 495-0755 Fax: (214) 495-0901
 e-mail info@isocom.com
 http://www.isocom.com

ABSOLUTE MAXIMUM RATINGS
(25°C unless otherwise specified)

Storage Temperature _____ -40°C to +125°C
 Operating Temperature _____ -25°C to +100°C
 Lead Soldering Temperature
 (1/16 inch (1.6mm) from case for 10 secs) 260°C

INPUT DIODE

Forward Current _____ 50mA
 Reverse Voltage _____ 6V
 Power Dissipation _____ 70mW

OUTPUT TRANSISTOR

Collector-emitter Voltage BV_{CEO} _____ 70V
 Emitter-collector Voltage BV_{ECO} _____ 6V
 Power Dissipation _____ 150mW

POWER DISSIPATION

Total Power Dissipation _____ 170mW
 (derate linearly 2.67mW/°C above 25°C)

ELECTRICAL CHARACTERISTICS ($T_A = 25^\circ\text{C}$ Unless otherwise noted)

PARAMETER		MIN	TYP	MAX	UNITS	TEST CONDITION
Input	Forward Voltage (V_F)		1.2	1.65	V	$I_F = 50\text{mA}$
	Reverse Current (I_R)			10	μA	$V_R = 4\text{V}$
Output	Collector-emitter Breakdown (BV_{CEO}) (Note 2)	70			V	$I_C = 1\text{mA}$
	Emitter-collector Breakdown (BV_{ECO})	6			V	$I_E = 100\mu\text{A}$
	Collector-emitter Dark Current (I_{CEO})			50	nA	$V_{CE} = 10\text{V}$
Coupled	Current Transfer Ratio (CTR) (Note 2)					
	IS201, ISD201, ISQ201	75			%	10mA I_F , 10V V_{CE}
	IS201, ISD201, ISQ201	10			%	1mA I_F , 10V V_{CE}
	IS202, ISD202, ISQ202	125		250	%	10mA I_F , 10V V_{CE}
	IS202, ISD202, ISQ202	30			%	1mA I_F , 10V V_{CE}
	IS203, ISD203, ISQ203	225		450	%	10mA I_F , 10V V_{CE}
	IS203, ISD203, ISQ203	50			%	1mA I_F , 10V V_{CE}
	IS204, ISD204, ISQ204	200		400	%	10mA I_F , 10V V_{CE}
	IS204, ISD204, ISQ204	100			%	1mA I_F , 10V V_{CE}
	Collector-emitter Saturation Voltage $V_{CE(SAT)}$		0.2	0.4	V	10mA I_F , 2mA I_C
	Input to Output Isolation Voltage V_{ISO}	5300			V_{RMS}	See note 1
	7500			V_{PK}	See note 1	
Input-output Isolation Resistance R_{ISO}	5×10^{10}			Ω	$V_{IO} = 500\text{V}$ (note 1)	
Output Turn on Time t_{ON}			3.0	μs	$I_F = 10\text{mA}$	
Output Turn off Time t_{OFF}			2.5	μs	$V_{CE} = 5\text{V}$, $R_L = 75\Omega$	

Note 1 Measured with input leads shorted together and output leads shorted together.

Note 2 Special Selections are available on request. Please consult the factory.

Collector Power Dissipation vs. Ambient Temperature

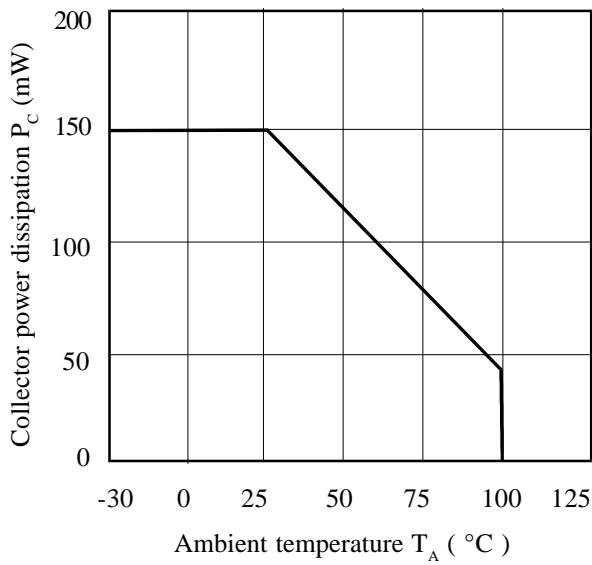

Relative Current Transfer Ratio vs. Ambient Temperature

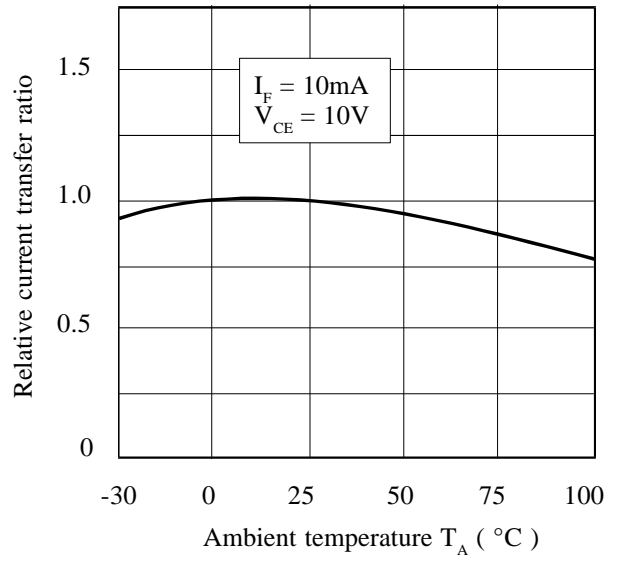

Forward Current vs. Ambient Temperature

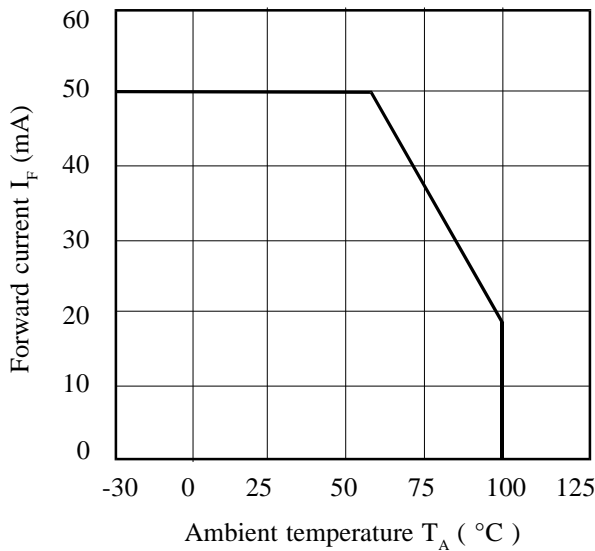

Relative Current Transfer Ratio vs. Ambient Temperature

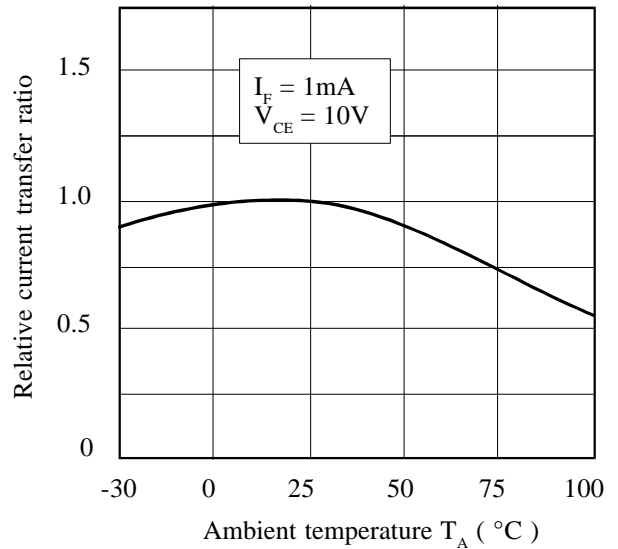

Collector-emitter Saturation Voltage vs. Ambient Temperature

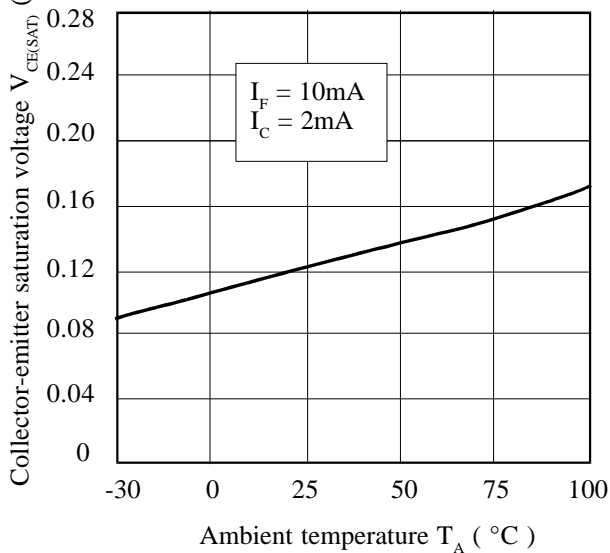

Relative Current Transfer Ratio vs. Forward Current

