

IS205X3,2,1
IS205-3,2,1



**LOW INPUT CURRENT NON-BASE
LEAD PHOTOTRANSISTOR
OPTICALLY COUPLED ISOLATOR**

APPROVALS

- UL recognised, File No. E91231
- 'X' SPECIFICATION APPROVALS
 - VDE 0884 in 3 available lead forms : -
 - STD
 - G form
 - SMD approved to CECC 00802
 - Certified to EN60950 by the following Test Bodies :-
 - Nemko - Certificate No. P96101299
 - Fimko - Registration No. 190469-01..22
 - Semko - Reference No. 9620076 01
 - Demko - Reference No. 305567

DESCRIPTION

The IS205-3, -2, -1 series of optically coupled isolators consist of infrared light emitting diode and NPN silicon photo transistor in a standard 6 pin dual in line plastic package with the base pin unconnected.

FEATURES

- Options :-
 - 10mm lead spread - add G after part no.
 - Surface mount - add SM after part no.
 - Tape&reel - add SMT&R after part no.
- Low input current 0.5mA I_F
- High Current Transfer Ratio (50% min)
- High Isolation Voltage (5.3kV_{RMS}, 7.5kV_{PK})
- Basepin unconnected for improved noise immunity in high EMI environment

APPLICATIONS

- DC motor controllers
- Industrial systems controllers
- Signal transmission between systems of different potentials and impedances

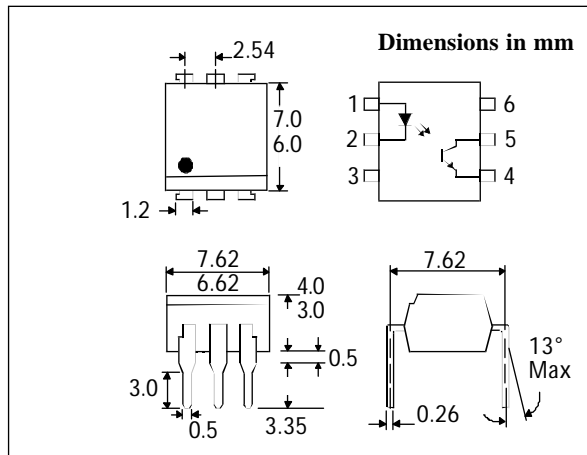
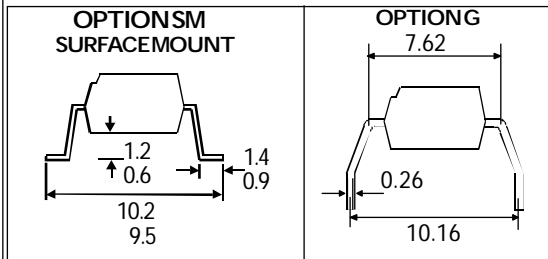

**ABSOLUTE MAXIMUM RATINGS
(25°C unless otherwise specified)**

Storage Temperature	_____	-55°C to + 150°C
Operating Temperature	_____	-55°C to + 100°C
Lead Soldering Temperature (1/16 inch (1.6mm) from case for 10 secs)	_____	260°C

INPUT DIODE

Forward Current	_____	60mA
Reverse Voltage	_____	10V
Power Dissipation	_____	105mW

OUTPUT TRANSISTOR

Collector-emitter Voltage BV_{CEO}	_____	70V
Emitter-collector Voltage BV_{ECO}	_____	6V
Power Dissipation	_____	160mW

POWER DISSIPATION

Total Power Dissipation	_____	200mW
(derate linearly 2.67mW/°C above 25°C)		

ISOCOM COMPONENTS LTD
Unit 25B, Park View Road West,
Park View Industrial Estate, Brenda Road
Hartlepool, Cleveland, TS25 1YD
Tel: (01429) 863609 Fax :(01429) 863581

ISOCOM INC
720 E., Park Boulevard, Suite 104,
Plano, TX 75074 USA
Tel: (972) 423-5521
Fax: (972) 422-4549

ELECTRICAL CHARACTERISTICS ($T_A = 25^\circ\text{C}$ Unless otherwise noted)

PARAMETER		MIN	TYP	MAX	UNITS	TEST CONDITION
Input	Forward Voltage (V_F)		1.2	1.4	V	$I_F = 20\text{mA}$
	Reverse Voltage (V_R)	10			V	$I_R = 10\mu\text{A}$
	Reverse Current (I_R)			10	μA	$V_R = 10\text{V}$
Output	Collector-emitter Breakdown (BV_{CEO}) (Note 2)	70			V	$I_C = 1\text{mA}$
	Emitter-collector Breakdown (BV_{ECO})	6			V	$I_E = 100\mu\text{A}$
	Collector-emitter Dark Current (I_{CEO})			50	nA	$V_{CE} = 10\text{V}$
Coupled	Current Transfer Ratio (CTR) (Note 2)					
	IS205-3	70			%	$0.5\text{mA } I_F, 0.4\text{V } V_{CE}$
		100			%	$1.0\text{mA } I_F, 0.4\text{V } V_{CE}$
	IS205-2	50			%	$0.5\text{mA } I_F, 0.4\text{V } V_{CE}$
	IS205-1	50			%	$1.0\text{mA } I_F, 0.4\text{V } V_{CE}$
	Collector-emitter Saturation Voltage -3			0.4	V	$0.5\text{mA } I_F, 0.35\text{mA } I_C$
	-2			0.4	V	$0.5\text{mA } I_F, 0.25\text{mA } I_C$
	-1			0.4	V	$1.0\text{mA } I_F, 0.5\text{mA } I_C$
	Input to Output Isolation Voltage V_{ISO}	5300			V_{RMS}	See note 1
		7500			V_{PK}	See note 1
Input-output Isolation Resistance R_{ISO}	5×10^{10}			Ω	$V_{IO} = 500\text{V}$ (note 1)	
Output Rise Time tr		4	18	μs	$V_{CE} = 2\text{V}$,	
Output Fall Time tf		3	18	μs	$I_C = 0.2\text{mA}, R_L = 100\Omega$	

Note 1 Measured with input leads shorted together and output leads shorted together.

Note 2 Special Selections are available on request. Please consult the factory.

Collector Power Dissipation vs. Ambient Temperature

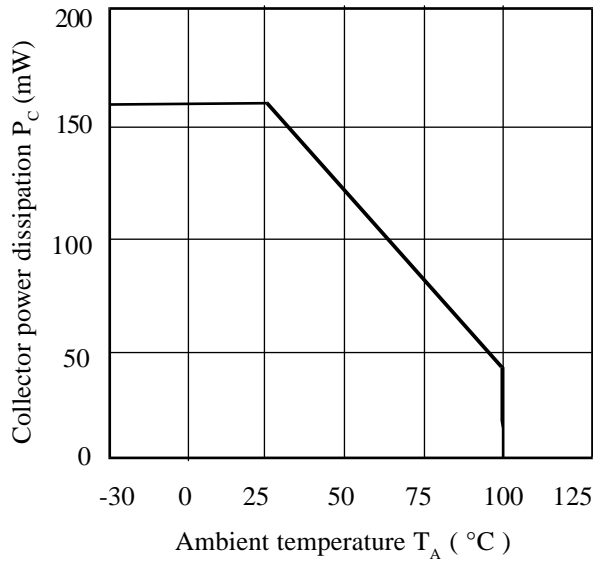

Collector Current vs. Low Collector-emitter Voltage

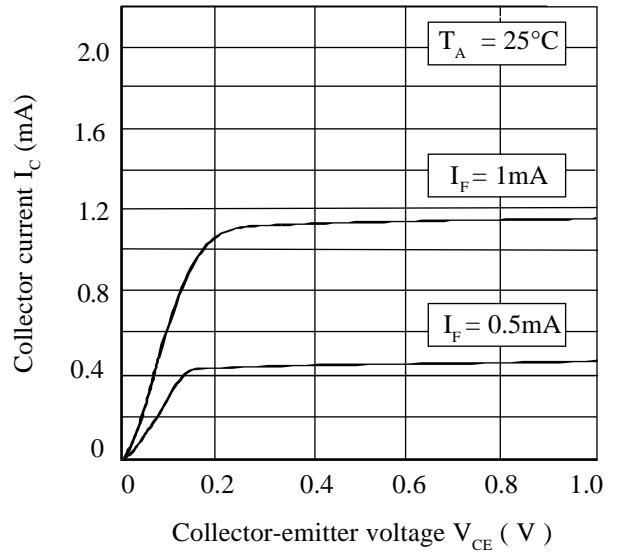

Forward Current vs. Ambient Temperature

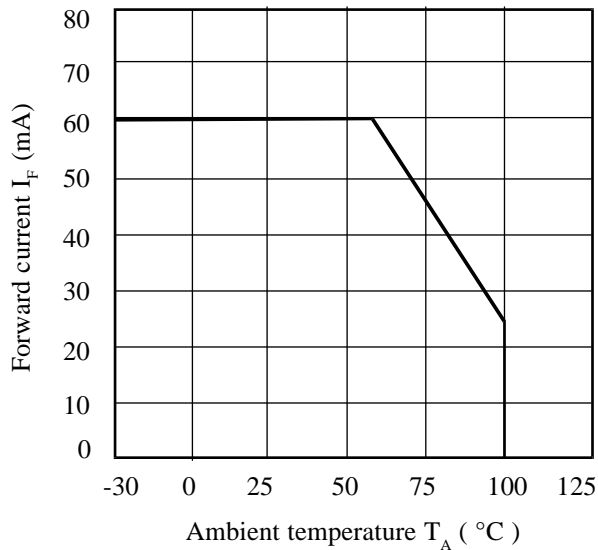

Relative Current Transfer Ratio vs. Ambient Temperature

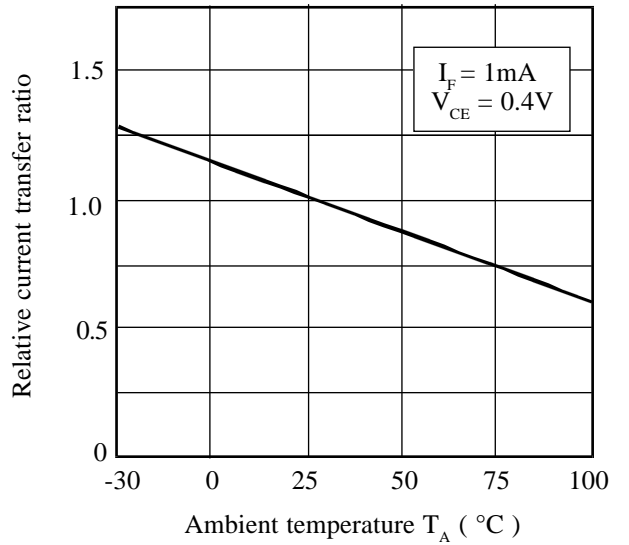

Collector-emitter Saturation Voltage vs. Ambient Temperature

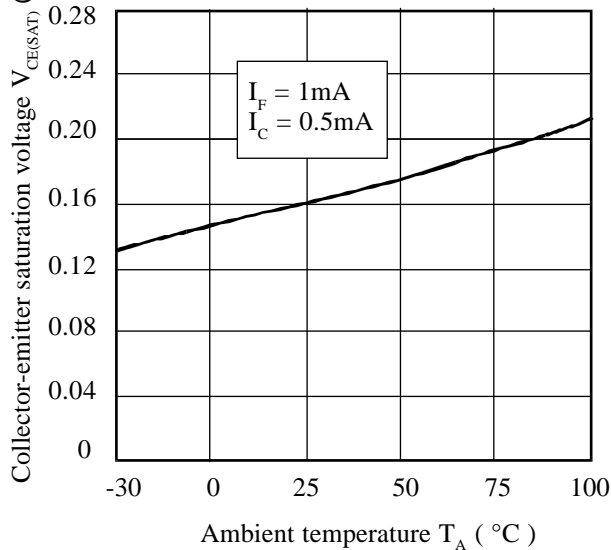

Current Transfer Ratio vs. Forward Current

