

40V, Low Quiescent Current, 50mA Linear Regulator

ISL80136

The [ISL80136](#) is a high voltage, low quiescent current linear regulator ideally suited for “always-on” and “keep alive” applications. The ISL80136 operates from an input voltage of +6V to +40V under normal operating conditions, consuming only 18µA of quiescent current at no load.

The ISL80136 offers adjustable output voltages from 2.5V to 12V. It features an EN pin that can be used to put the device into a low-quiescent current shutdown mode where it draws only 1.8µA of supply current. The device features over-temperature shutdown and current limit protection.

The ISL80136 is rated over the -40°C to +125°C temperature range and is available in an 8 lead EPSONC with an exposed pad package.

TABLE 1. KEY DIFFERENCES IN FAMILY OF 40V LDO PARTS

PART NUMBER	MINIMUM I _{OUT}	IC PACKAGE
ISL80136	50mA	8 Ld EPSONC
ISL80138	150mA	14 Ld HTSSOP

Features

- Wide V_{IN} range of 6V to 40V
- Adjustable output voltage from 2.5V to 12V
- Guaranteed 50mA output current
- Ultra low 18µA typical quiescent current
- Low 1.8µA of typical shutdown current
- ±1% accurate voltage reference
- Low dropout voltage of 120mV at 50mA
- 40V tolerant logic level (TTL/CMOS) enable input
- Stable operation with 10µF output capacitor
- 5kV ESD HBM rated
- Thermal shutdown and current limit protection

Applications

- Industrial
- Networking
- Telecom

Related Literature

- [ISL80138](#), “40V, Low Quiescent Current, 150mA Linear Regulator”
- AN1784, “ISL80136EVAL1Z, ISL80138EVAL1Z Evaluation Boards User Guide”

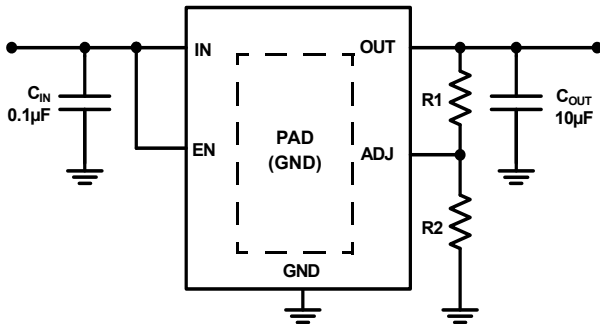

FIGURE 1. TYPICAL APPLICATION

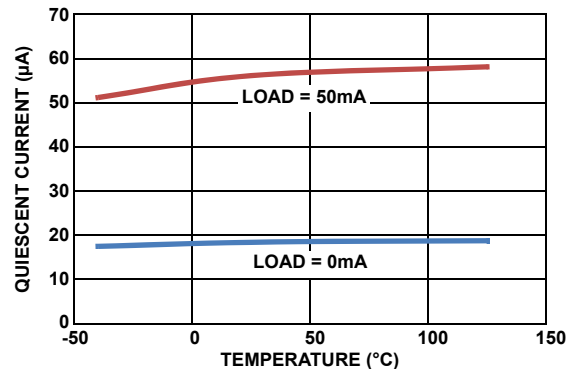
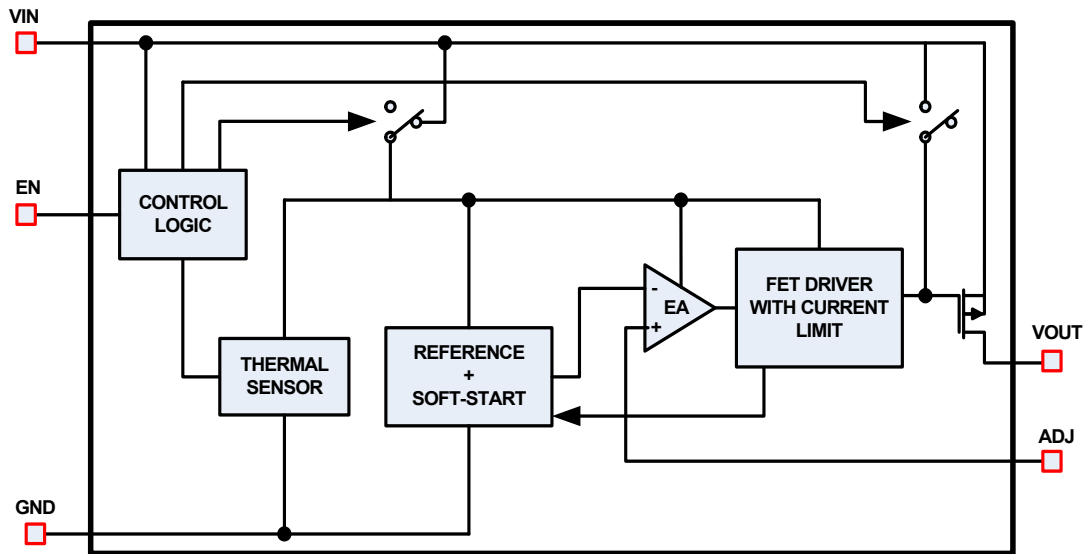

FIGURE 2. QUIESCENT CURRENT vs LOAD CURRENT (AT UNITY GAIN), V_{IN} = 14V

ISL80136

Block Diagram



Pin Configuration

ISL80136
(8 LD EPSON)
TOP VIEW

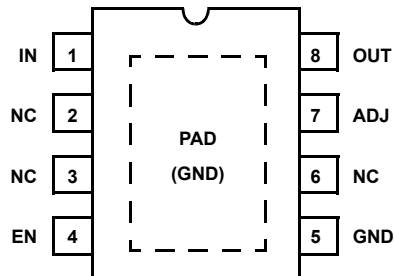

Pin Descriptions

PIN #	PIN NAME	DESCRIPTION
1	IN	Input voltage pin. A minimum 0.1 μ F X5R/X7R capacitor is required for proper operation. Range: 6V to 40V
2, 3, 6	NC	Pins have internal termination and can be left not connected. Connection to ground is optional.
4	EN	High on this pin enables the device. Range: 0V to V_{IN}
5	GND	Ground pin.
7	ADJ	This pin is connected to the external feedback resistor divider, which sets the LDO output voltage.
8	OUT	Regulated output voltage. A 10 μ F X5R/X7R output capacitor is required for stability. Range: 0V to 12V
-	PAD	It is recommended to solder the PAD to the ground plane.

ISL80136

Ordering Information

PART NUMBER (Notes 1, 2, 3)	PART MARKING	TEMP. RANGE (°C)	ENABLE PIN	OUTPUT VOLTAGE (V)	PACKAGE (RoHS Compliant)	PKG. DWG. #
ISL80136IBEAJZ	80136 IBEAJZ	-40 to +125	Yes	ADJ	8 Ld EPSOIC	M8.15B
ISL80136EVAL1Z	Evaluation Platform					

NOTES:

1. Add "-T*" suffix for tape and reel. Please refer to [TB347](#) for details on reel specifications.
2. These Intersil Pb-free plastic packaged products employ special Pb-free material sets, molding compounds/die attach materials, and 100% matte tin plate plus anneal (e3 termination finish, which is RoHS compliant and compatible with both SnPb and Pb-free soldering operations). Intersil Pb-free products are MSL classified at Pb-free peak reflow temperatures that meet or exceed the Pb-free requirements of IPC/JEDEC J STD-020.
3. For Moisture Sensitivity Level (MSL), please see device information page for [ISL80136](#). For more information on MSL please see techbrief [TB363](#).

ISL80136

Absolute Maximum Ratings

IN Pin to GND Voltage	GND - 0.3V to +45V
OUT Pin to GND Voltage	GND - 0.3V to 16V
EN Pin to GND Voltage	GND - 0.3V to IN
ADJ Pin to GND Voltage	GND - 0.3V to 3V
Output Short-circuit Duration	Indefinite
ESD Rating	
Human Body Model (Tested per JESD22-A114E)	5kV
Machine Model (Tested per JESD-A115-A)	200V
Charge Device Model (Tested per JESD22-C101C)	2.2kV
Latch-up (Tested per JESD78B; Class II, Level A)	100mA

Thermal Information

Thermal Resistance (Typical)	θ_{JA} (°C/W)	θ_{JC} (°C/W)
8 Ld EPSON Package (Notes 4, 5)	50	9
Maximum Junction Temperature	+150°C	
Maximum Storage Temperature Range	-65°C to +175°C	
Pb-free Reflow Profile	see TB493	

Recommended Operating Conditions

Ambient Temperature Range	-40°C to +125°C
IN Pin to GND Voltage	+6V to +40V
OUT Pin to GND Voltage	+2.5V to +12V
EN Pin to GND Voltage	0V to +40V

CAUTION: Do not operate at or near the maximum ratings listed for extended periods of time. Exposure to such conditions may adversely impact product reliability and result in failures not covered by warranty.

NOTES:

- θ_{JA} is measured in free air with the component mounted on a high effective thermal conductivity test board with “direct attach” features. See Tech Brief [TB379](#).
- For θ_{JC} , the “case temp” location is the center of the exposed metal pad on the package underside.

Electrical Specifications Recommended Operating Conditions, unless otherwise noted. $V_{IN} = 14V$, $I_{OUT} = 1mA$, $T_A = T_J = -40^\circ C$ to $+125^\circ C$, unless otherwise noted. Typical specifications are at $T_A = +25^\circ C$. **Boldface limits apply across the operating temperature range, -40°C to +125°C.**

PARAMETER	SYMBOL	TEST CONDITIONS	MIN (Note 8)	TYP	MAX (Note 8)	UNITS
Input Voltage Range	V_{IN}		6		40	V
Guaranteed Output Current	I_{OUT}	$V_{IN} = V_{OUT} + V_{DO}$	50			mA
ADJ Reference Voltage	V_{REF}	EN = High, $V_{IN} = 14V$, $I_{OUT} = 0.1mA$ to 50mA	1.211	1.223	1.235	V
Line Regulation	$(V_{OUT\ low\ line} - V_{OUT\ high\ line}) / V_{OUT\ low\ line}$	$6V < V_{IN} < 40V$, $I_{OUT} = 1mA$		0.04	0.115	%
Load Regulation	$(V_{OUT\ no\ load} - V_{OUT\ high\ load}) / V_{OUT\ no\ load}$	$V_{IN} = 14V$, $I_{OUT} = 100\mu A$ to 50mA		0.25	0.5	%
Dropout Voltage (Note 6)	ΔV_{DO}	$I_{OUT} = 1mA$, $V_{OUT} = 2.5V$		10	38	mV
		$I_{OUT} = 50mA$, $V_{OUT} = 2.5V$		130	340	mV
		$I_{OUT} = 1mA$, $V_{OUT} = 5V$		10	48	mV
		$I_{OUT} = 50mA$, $V_{OUT} = 5V$		120	350	mV
Shutdown Current	I_{SHDN}	EN = LOW		1.8	3.64	μA
Quiescent Current	IQ	EN = HIGH, $I_{OUT} = 0mA$		18	24	μA
		EN = HIGH, $I_{OUT} = 1mA$		22	42	μA
		EN = HIGH, $I_{OUT} = 10mA$		34	60	μA
		EN = HIGH, $I_{OUT} = 50mA$		56	82	μA
Power Supply Rejection Ratio	PSRR	f = 100Hz; $V_{IN_RIPPLE} = 500mV_{P-P}$; Load = 50mA		58		dB
EN FUNCTION						
EN Threshold Voltage	V_{EN_H}	$V_{OUT} = \text{Off to On}$			1.485	V
	V_{EN_L}	$V_{OUT} = \text{On to Off}$	0.935			V
EN Pin Current	I_{EN}	$V_{OUT} = 0V$		0.026		μA
EN to Regulation Time (Note 7)	t_{EN}			1.65	1.93	ms

ISL80136

Electrical Specifications Recommended Operating Conditions, unless otherwise noted. $V_{IN} = 14V$, $I_{OUT} = 1mA$, $T_A = T_J = -40^\circ C$ to $+125^\circ C$, unless otherwise noted. Typical specifications are at $T_A = +25^\circ C$. **Boldface limits apply across the operating temperature range, $-40^\circ C$ to $+125^\circ C$.** (Continued)

PARAMETER	SYMBOL	TEST CONDITIONS	MIN (Note 8)	TYP	MAX (Note 8)	UNITS
PROTECTION FEATURES						
Output Current Limit	I_{LIMIT}	$V_{OUT} = 0V$	60	118		mA
Thermal Shutdown	T_{SHDN}	Junction Temperature Rising		+165		$^\circ C$
Thermal Shutdown Hysteresis	T_{HYST}			+20		$^\circ C$

NOTES:

- Dropout voltage is defined as $(V_{IN} - V_{OUT})$ when V_{OUT} is 2% below the value of V_{OUT} .
- Enable to Regulation is the time the output takes to reach 95% of its final value with $V_{IN} = 14V$ and EN is taken from V_{IL} to V_{IH} in 5ns. The output voltage is set at 5V.
- Parameters with MIN and/or MAX limits are 100% tested at $+25^\circ C$, unless otherwise specified. Temperature limits established by characterization and are not production tested.

Typical Performance Curves $V_{IN} = 14V, I_{OUT} = 1mA, V_{OUT} = 5V, T_J = +25^\circ C$ unless otherwise specified.

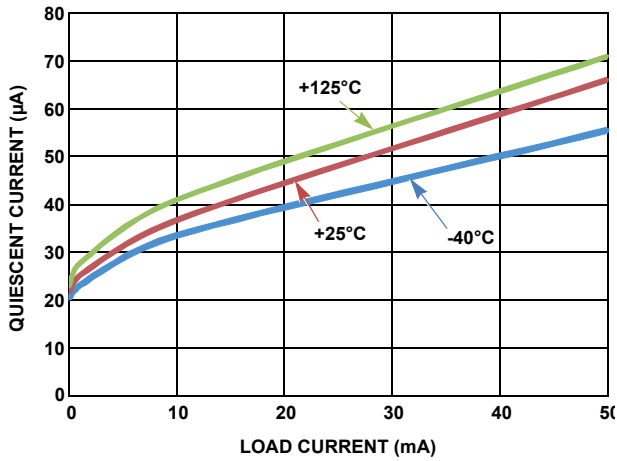

FIGURE 3. QUIESCENT CURRENT vs LOAD CURRENT

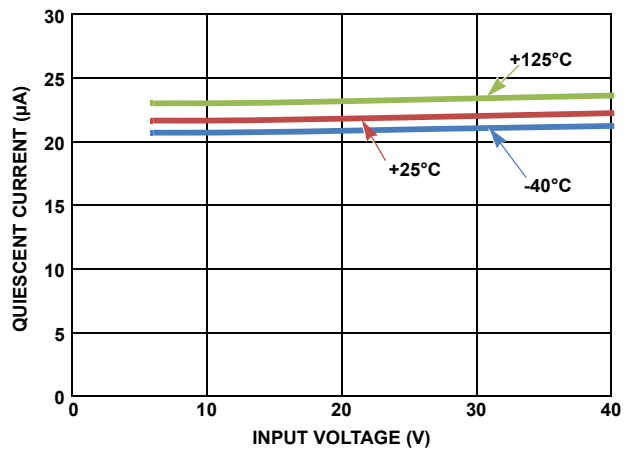

FIGURE 4. QUIESCENT CURRENT vs INPUT VOLTAGE (NO LOAD)

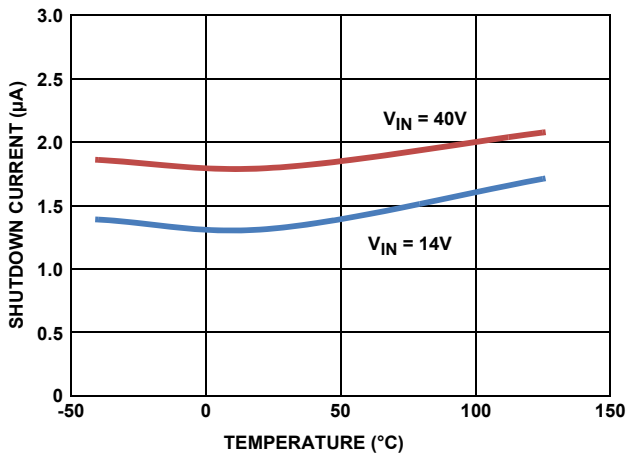

FIGURE 5. SHUTDOWN CURRENT vs TEMPERATURE (EN = 0)

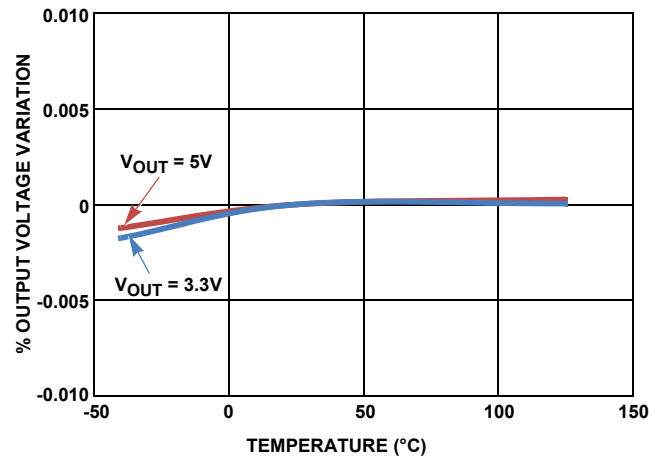

FIGURE 6. OUTPUT VOLTAGE vs TEMPERATURE (LOAD = 50mA)

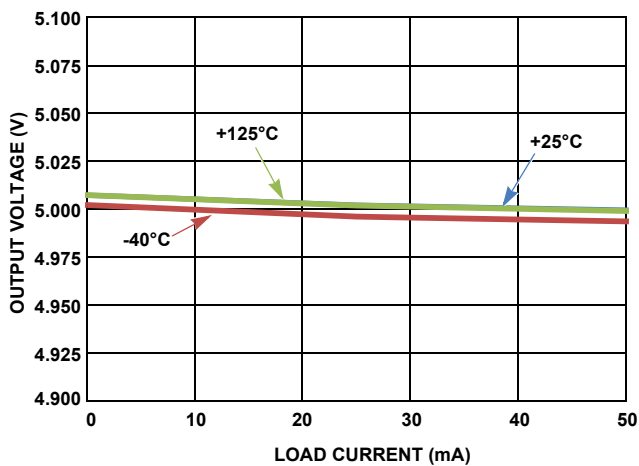

FIGURE 7. OUTPUT VOLTAGE vs LOAD CURRENT

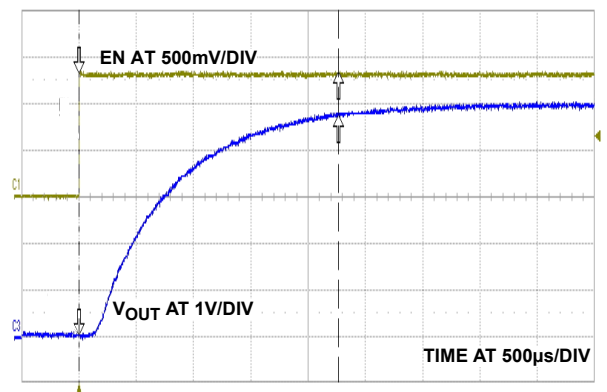

FIGURE 8. START-UP WAVEFORM

Typical Performance Curves $V_{IN} = 14V, I_{OUT} = 1mA, V_{OUT} = 5V, T_J = +25^\circ C$ unless otherwise specified. (Continued)

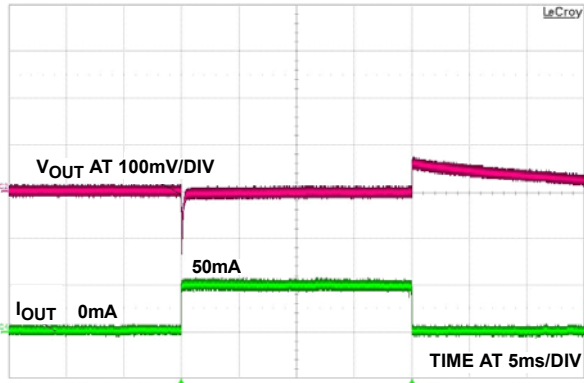

FIGURE 9. LOAD TRANSIENT RESPONSE

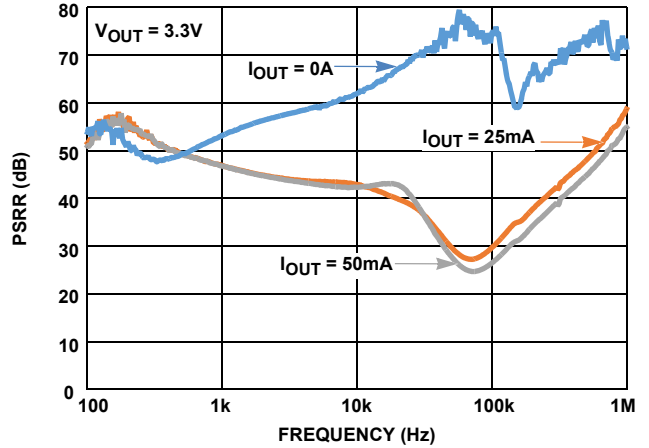

FIGURE 10. PSRR vs FREQUENCY FOR VARIOUS LOAD CURRENT, $V_{OUT} = 3.3V$

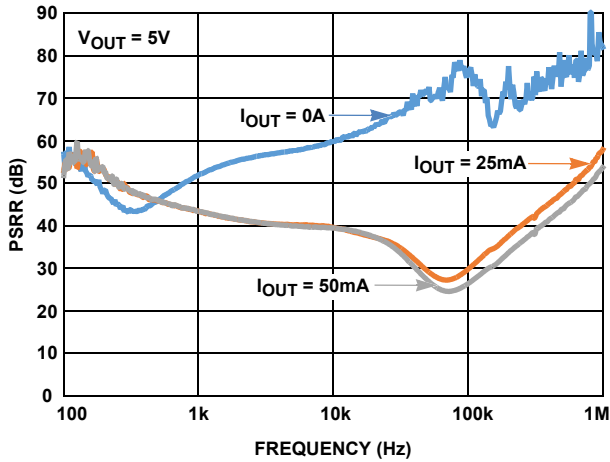

FIGURE 11. PSRR vs FREQUENCY FOR VARIOUS LOAD CURRENT, $V_{OUT} = 5V$

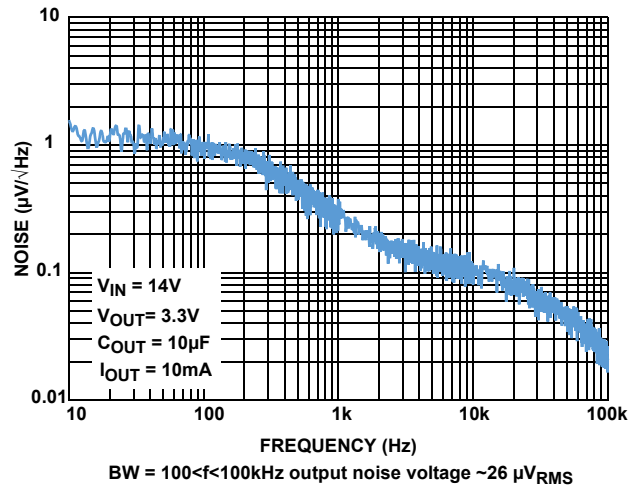

FIGURE 12. OUTPUT NOISE SPECTRAL DENSITY, $I_{OUT} = 10mA$

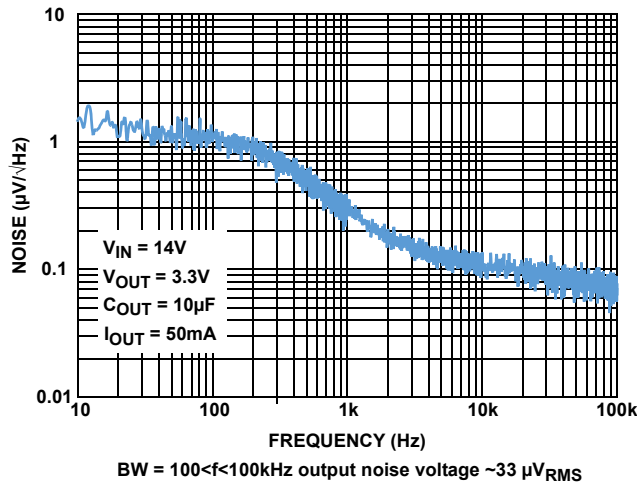

FIGURE 13. OUTPUT NOISE SPECTRAL DENSITY, $I_{OUT} = 50mA$

Functional Description

Functional Overview

The ISL80136 is a high performance, high voltage, low-dropout regulator (LDO) with 50mA sourcing capability. The part is rated to operate across the -40°C to $+125^{\circ}\text{C}$ temperature range. Featuring ultra-low quiescent current, it makes an ideal choice for “always-on” applications. It works well under a “load dump condition” where the input voltage could rise up to 40V. The device also features current limit and thermal shutdown protection.

Enable Control

The ISL80136 features an Enable pin. When it is pulled low, the IC goes into shutdown mode. In this condition, the device draws less than $2\mu\text{A}$. Driving the pin high turns the device on. For always on operation, the EN pin can be tied directly to IN.

Current Limit Protection

The ISL80136 has internal current limit functionality to protect the regulator during fault conditions. During current limit, the output sources a fixed amount of current largely independent of the output voltage. If the short or overload is removed from V_{OUT} , the output returns to normal voltage regulation mode.

Thermal Fault Protection

In the event that the die temperature exceeds typically $+165^{\circ}\text{C}$, the output of the LDO will shut down until the die temperature cools down to typically $+145^{\circ}\text{C}$. The level of power dissipated, combined with the ambient temperature and the thermal impedance of the package, will determine if the junction temperature exceeds the thermal shutdown temperature. Also see the section on “[Power Dissipation](#)”.

Application Information

Input and Output Capacitors

For the output, a ceramic capacitor (X5R or X7R) with a capacitance of $10\mu\text{F}$ is recommended for the ISL80136 to maintain stability. The ground connection of the output capacitor should be routed directly to the GND pin of the device and also placed close to the IC. A minimum of $0.1\mu\text{F}$ (X5R or X7R) is recommended at the input.

Output Voltage Setting

The output voltage is programmed using an external resistor divider, as shown in [Figure 14](#).

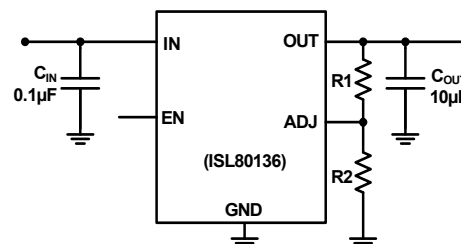

FIGURE 14. SETTING OUTPUT VOLTAGE

The output voltage is calculated using [Equation 1](#):

$$V_{\text{OUT}} = 1.223\text{V} \times \left(\frac{R1}{R2} + 1 \right) \quad (\text{EQ. 1})$$

Power Dissipation

The junction temperature must not exceed the range specified in “Recommended Operating Conditions” on page 4. The power dissipation can be calculated using [Equation 2](#):

$$P_D = (V_{\text{IN}} - V_{\text{OUT}}) \times I_{\text{OUT}} + V_{\text{IN}} \times I_{\text{GND}} \quad (\text{EQ. 2})$$

The maximum allowable junction temperature, $T_{\text{J}(\text{MAX})}$ and the maximum expected ambient temperature, $T_{\text{A}(\text{MAX})}$ will determine the maximum allowable junction temperature rise (ΔT_{J}), as shown in [Equation 3](#):

$$\Delta T_{\text{J}} = T_{\text{J}(\text{MAX})} - T_{\text{A}(\text{MAX})} \quad (\text{EQ. 3})$$

To calculate the maximum ambient operating temperature, use the junction-to-ambient thermal resistance (θ_{JA}), as shown in [Equation 4](#):

$$T_{\text{J}(\text{MAX})} = P_{\text{D}(\text{MAX})} \times \theta_{\text{JA}} + T_{\text{A}} \quad (\text{EQ. 4})$$

Board Layout Recommendations

A good PCB layout is important to achieve expected performance. Consideration should be taken when placing the components and routing the trace to minimize the ground impedance, and keep the parasitic inductance low. The input and output capacitors should have a good ground connection and be placed as close to the IC as possible. The ADJ feedback trace should be away from other noisy traces. Connect the exposed pad to the ground plane using as many vias as possible within the pad for the best thermal relief.

Revision History

The revision history provided is for informational purposes only and is believed to be accurate, but not warranted. Please go to web to make sure you have the latest Rev.

DATE	REVISION	CHANGE
August 11, 2015	FN7970.2	<p>Removed DFN package option throughout the datasheet.</p> <p>On page 1, updated Key Differences Table, Replaced "ADJ OR FIXED VOUT" Column with "IC PACKAGE" column.</p> <p>On page 2, updated Block Diagram, removed two resistors and switched polarity of EA.</p> <p>Electrical spec table on page 4:</p> <ul style="list-style-type: none"> -Removed "C_{IN} = 0.1μF, C_{OUT} = 10μF" from the Electrical Specification heading. -Updated the ADJ Reference Voltage Test Condition IOUT value from "IOUT = 0.1mA" to "IOUT = 0.1mA to 50mA" -Updated the Line Regulation <ul style="list-style-type: none"> *Symbol, from "$\Delta V_{OUT}/\Delta V_{IN}$" to "$(V_{OUT\ low\ line} - V_{OUT\ high\ line})/V_{OUT\ low\ line}$". *Test Conditions, from "$3V \leq V_{IN} \leq 40V, I_{OUT} = 1mA$" to "$6V < V_{IN} < 40V, I_{OUT} = 1mA$" -Updated the Load Regulation <ul style="list-style-type: none"> *Symbol, from "$\Delta V_{OUT}/\Delta I_{OUT}$" to "$(V_{OUT\ no\ load} - V_{OUT\ high\ load})/V_{OUT\ no\ load}$". *Test Conditions from "$V_{IN} = V_{OUT} + V_{DO}$" to "$V_{IN} = 14V$" -Updated Dropout Voltage Test Condition VOUT value (First two rows only) from "VOUT = 3.3V" to "VOUT = 2.5V". <p>Updated Note 6 from "Dropout voltage is defined as $(V_{IN} - V_{OUT})$ when V_{OUT} is 2% below the value of V_{OUT} when $V_{IN} = V_{OUT} + 3V$." to "Dropout voltage is defined as $(V_{IN} - V_{OUT})$ when V_{OUT} is 2% below the value of V_{OUT}."</p> <p>Removed Figure 9, "POWER SUPPLY REJECTION RATIO (LOAD = 50mA)"</p> <p>Added figures 10 through 13 on page 7.</p>
January 31, 2012	FN7970.1	Added DFN package option throughout the datasheet.
December 15, 2011	FN7970.0	Initial Release.

About Intersil

Intersil Corporation is a leading provider of innovative power management and precision analog solutions. The company's products address some of the largest markets within the industrial and infrastructure, mobile computing and high-end consumer markets.

For the most updated datasheet, application notes, related documentation and related parts, please see the respective product information page found at www.intersil.com.

You may report errors or suggestions for improving this datasheet by visiting www.intersil.com/ask.

Reliability reports are also available from our website at www.intersil.com/support

For additional products, see www.intersil.com/en/products.html

Intersil products are manufactured, assembled and tested utilizing ISO9001 quality systems as noted in the quality certifications found at www.intersil.com/en/support/qualandreliability.html

Intersil products are sold by description only. Intersil Corporation reserves the right to make changes in circuit design, software and/or specifications at any time without notice. Accordingly, the reader is cautioned to verify that data sheets are current before placing orders. Information furnished by Intersil is believed to be accurate and reliable. However, no responsibility is assumed by Intersil or its subsidiaries for its use; nor for any infringements of patents or other rights of third parties which may result from its use. No license is granted by implication or otherwise under any patent or patent rights of Intersil or its subsidiaries.

For information regarding Intersil Corporation and its products, see www.intersil.com

Small Outline Exposed Pad Plastic Packages (EPSOIC)

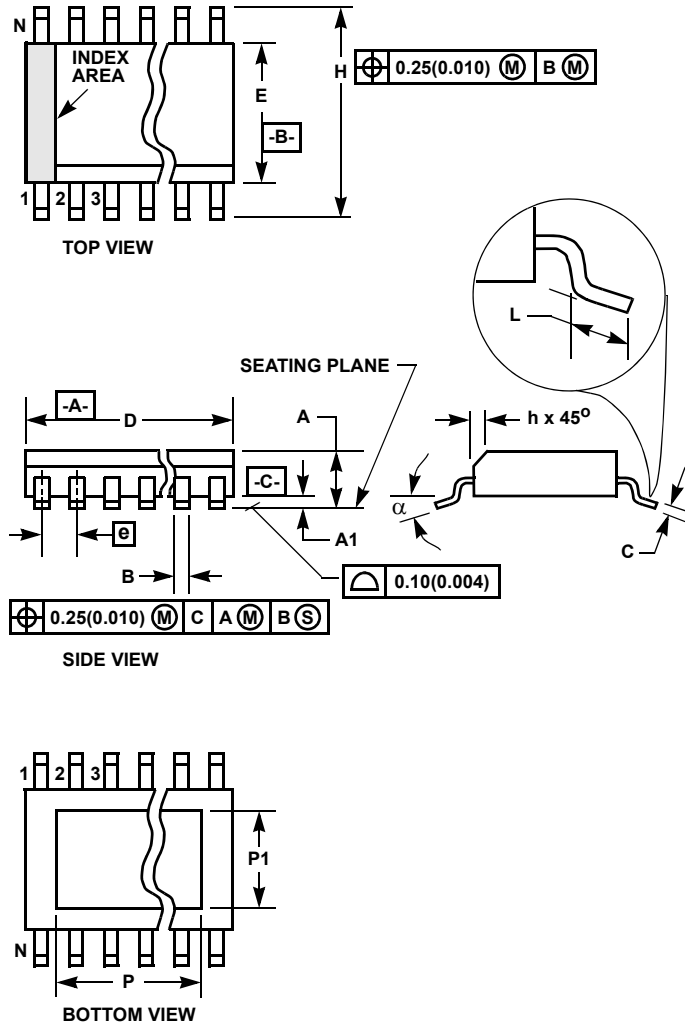

M8.15B
8 LEAD NARROW BODY SMALL OUTLINE EXPOSED PAD
PLASTIC PACKAGE

SYMBOL	INCHES		MILLIMETERS		NOTES
	MIN	MAX	MIN	MAX	
A	0.056	0.066	1.43	1.68	-
A1	0.001	0.005	0.03	0.13	-
B	0.0138	0.0192	0.35	0.49	9
C	0.0075	0.0098	0.19	0.25	-
D	0.189	0.196	4.80	4.98	3
E	0.150	0.157	3.81	3.99	4
e	0.050 BSC		1.27 BSC		-
H	0.230	0.244	5.84	6.20	-
h	0.010	0.016	0.25	0.41	5
L	0.016	0.035	0.41	0.89	6
N	8		8		7
α	0°	8°	0°	8°	-
P	-	0.094	-	2.387	11
P1	-	0.094	-	2.387	11

Rev. 5 8/10

NOTES:

1. Symbols are defined in the "MO Series Symbol List" in Section 2.2 of Publication Number 95.
2. Dimensioning and tolerancing per ANSI Y14.5M-1982.
3. Dimension "D" does not include mold flash, protrusions or gate burrs. Mold flash, protrusion and gate burrs shall not exceed 0.15mm (0.006 inch) per side.
4. Dimension "E" does not include interlead flash or protrusions. Interlead flash and protrusions shall not exceed 0.25mm (0.010 inch) per side.
5. The chamfer on the body is optional. If it is not present, a visual index feature must be located within the crosshatched area.
6. "L" is the length of terminal for soldering to a substrate.
7. "N" is the number of terminal positions.
8. Terminal numbers are shown for reference only.
9. The lead width "B", as measured 0.36mm (0.014 inch) or greater above the seating plane, shall not exceed a maximum value of 0.61mm (0.024 inch).
10. Controlling dimension: INCH. Converted millimeter dimensions are not necessarily exact.
11. Dimensions "P" and "P1" are thermal and/or electrical enhanced variations. Values shown are maximum size of exposed pad within lead count and body size.