

HiPerFET™ Power MOSFETs Q-Class

N-Channel Enhancement Mode
Avalanche Rated, High dv/dt, Low Q_g

IXFH 80N15Q
IXFK 80N15Q
IXFT 80N15Q

V_{DSS} = 150 V
I_{D25} = 80 A
R_{DS(on)} = 22.5 mΩ
t_{rr} ≤ 200 ns

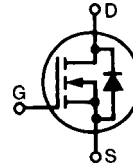

Preliminary data sheet

Symbol	Test Conditions	Maximum Ratings	
V _{DSS}	T _J = 25°C to 150°C	150	V
V _{DGR}	T _J = 25°C to 150°C; R _{GS} = 1 MΩ	150	V
V _{GS}	Continuous	±20	V
V _{GSM}	Transient	±30	V
I _{D25}	T _C = 25°C	80	A
I _{DM}	T _C = 25°C, pulse width limited by T _{JM}	320	A
I _{AR}	T _C = 25°C	80	A
E _{AR}	T _C = 25°C	45	mJ
E _{AS}	T _C = 25°C	1.5	J
dv/dt	I _S ≤ I _{DM} , di/dt ≤ 100 A/μs, V _{DD} ≤ V _{DSS} , T _J ≤ 150°C, R _G = 2 Ω	5	V/ns
P _D	T _C = 25°C	360	W
T _J		-55 ... +150	°C
T _{JM}		150	°C
T _{stg}		-55 ... +150	°C
T _L	1.6 mm (0.063 in) from case for 10 s	300	°C
M _d	Mounting torque	TO-247 TO-264	1.13/10 Nm/lb.in. 0.9/6 Nm/lb.in.
Weight		TO-247 TO-264 TO-268	6 10 4 g

TO-247 AD (IXFH)

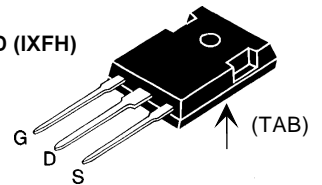

TO-268 (D3) (IXFT)

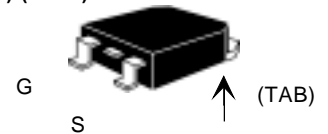

TO-264 AA (IXFK)

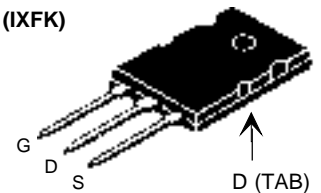

G = Gate
S = Source

TAB = Drain

Symbol	Test Conditions	Characteristic Values (T _J = 25°C, unless otherwise specified)		
		min.	typ.	max.
V _{DSS}	V _{GS} = 0 V, I _D = 250 μA	150		V
V _{GS(th)}	V _{DS} = V _{GS} , I _D = 4 mA	2.0		4.0 V
I _{GSS}	V _{GS} = ±20 V _{DC} , V _{DS} = 0			±100 nA
I _{DSS}	V _{DS} = V _{DSS} , V _{GS} = 0 V			25 μA 1 mA
R _{DS(on)}	V _{GS} = 10 V, I _D = 0.5 • I _{D25} Pulse test, t ≤ 300 μs, duty cycle d ≤ 2 %			22.5 mΩ

Features

- Low gate charge
- International standard packages
- Epoxy meet UL 94 V-0, flammability classification
- Low R_{DS(on)} HDMOS™ process
- Rugged polysilicon gate cell structure
- Avalanche energy and current rated
- Fast intrinsic Rectifier

Advantages

- Easy to mount
- Space savings
- High power density

Symbol	Test Conditions	Characteristic Values ($T_J = 25^\circ\text{C}$, unless otherwise specified)		
		min.	typ.	max.
g_{fs}	$V_{DS} = 10\text{ V}; I_D = 0.5 \cdot I_{D25}$, pulse test	35	50	S
C_{iss}	$V_{GS} = 0\text{ V}, V_{DS} = 25\text{ V}, f = 1\text{ MHz}$	4500		pF
C_{oss}		1400		pF
C_{rss}		680		pF
$t_{d(on)}$	$V_{GS} = 10\text{ V}, V_{DS} = 0.5 \cdot V_{DSS}, I_D = 0.5 \cdot I_{D25}$ $R_G = 2.0\ \Omega$ (External),	30		ns
t_r		55		ns
$t_{d(off)}$		68		ns
t_f		20		ns
$Q_{g(on)}$	$V_{GS} = 10\text{ V}, V_{DS} = 0.5 \cdot V_{DSS}, I_D = 0.5 \cdot I_{D25}$	180		nC
Q_{gs}		39		nC
Q_{gd}		85		nC
R_{thJC}			0.35	K/W
R_{thCK}	TO-247	0.25		K/W
	TO-264	0.15		K/W

TO-247 AD (IXFH) Outline

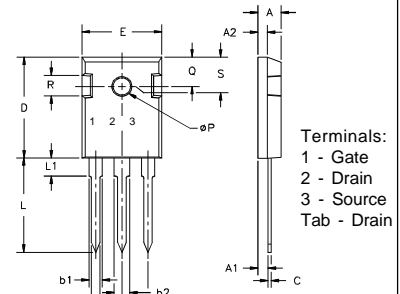

Terminals:
 1 - Gate
 2 - Drain
 3 - Source
 Tab - Drain

Dim.	Millimeter		Inches	
	Min.	Max.	Min.	Max.
A	4.7	5.3	.185	.209
A ₁	2.2	2.54	.087	.102
A ₂	2.2	2.6	.059	.098
b	1.0	1.4	.040	.055
b ₁	1.65	2.13	.065	.084
b ₂	2.87	3.12	.113	.123
C	.4	.8	.016	.031
D	20.80	21.46	.819	.845
E	15.75	16.26	.610	.640
e	5.20	5.72	0.205	0.225
L	19.81	20.32	.780	.800
L ₁		4.50		.177
∅P	3.55	3.65	.140	.144
Q	5.89	6.40	0.232	0.252
R	4.32	5.49	.170	.216
S	6.15	BSC	242	BSC

Source-Drain Diode

Characteristic Values

($T_J = 25^\circ\text{C}$, unless otherwise specified)

Symbol	Test Conditions	min.	typ.	max.
I_S	$V_{GS} = 0\text{ V}$			80 A
I_{SM}	Repetitive; pulse width limited by T_{JM}			320 A
V_{SD}	$I_F = I_S, V_{GS} = 0\text{ V}$, Pulse test, $t \leq 300\ \mu\text{s}$, duty cycle $d \leq 2\%$			1.5 V
t_{rr}	$I_F = I_S - di/dt = 100\text{ A}/\mu\text{s}, V_R = 100\text{ V}$	1.2		ns
Q_{RM}		10		μC
I_{RM}				A

TO-264 AA Outline

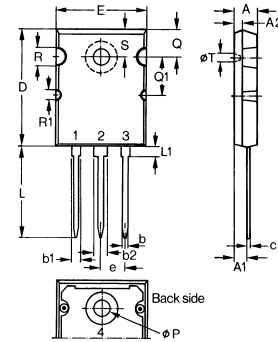

Dim.	Millimeter		Inches	
	Min.	Max.	Min.	Max.
A	4.82	5.13	.190	.202
A ₁	2.54	2.89	.100	.114
A ₂	2.00	2.10	.079	.083
b	1.12	1.42	.044	.056
b ₁	2.39	2.69	.094	.106
b ₂	2.90	3.09	.114	.122
c	0.53	0.83	.021	.033
D	25.91	26.16	1.020	1.030
E	19.81	19.96	.780	.786
e	5.46 BSC		.215 BSC	
J	0.00	0.25	.000	.010
K	0.00	0.25	.000	.010
L	20.32	20.83	.800	.820
L ₁	2.29	2.59	.090	.102
P	3.17	3.66	.125	.144
Q	6.07	6.27	.239	.247
Q ₁	8.38	8.69	.330	.342
R	3.81	4.32	.150	.170
R ₁	1.78	2.29	.070	.090
S	6.04	6.30	.238	.248
T	1.57	1.83	.062	.072

TO-268 Outline

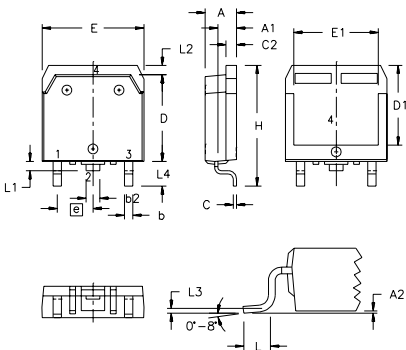

Terminals:
 1 - Gate
 2 - Drain
 3 - Source
 Tab - Drain

SYM	INCHES		MILLIMETERS	
	MIN	MAX	MIN	MAX
A	.193	.201	4.90	5.10
A ₁	.106	.114	2.70	2.90
A ₂	.001	.010	0.02	0.25
b	.045	.057	1.15	1.45
b ₁	.075	.083	1.90	2.10
C	.016	.026	0.40	0.65
C ₂	.057	.063	1.45	1.60
D	.543	.551	13.80	14.00
D ₁	.488	.500	12.40	12.70
E	.624	.632	15.85	16.05
E ₁	.524	.535	13.30	13.60
e	.215 BSC		5.45 BSC	
H	.736	.752	18.70	19.10
L	.094	.106	2.40	2.70
L ₁	.047	.055	1.20	1.40
L ₂	.039	.045	1.00	1.15
L ₃	.010 BSC		0.25 BSC	
L ₄	.150	.161	3.80	4.10

IXYS reserves the right to change limits, test conditions, and dimensions.

IXYS MOSFETS and IGBTs are covered by one or more of the following U.S. patents: 4,835,592 4,881,106 5,017,508 5,049,961 5,187,117 5,486,715
 4,850,072 4,931,844 5,034,796 5,063,307 5,237,481 5,381,025