

HiperFET™
Power MOSFETs
Q3-Class

IXFT18N100Q3
IXFH18N100Q3

$$V_{DSS} = 1000V$$

$$I_{D25} = 18A$$

$$R_{DS(on)} \leq 660m\Omega$$

N-Channel Enhancement Mode
 Avalanche Rated
 Fast Intrinsic Rectifier

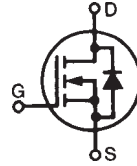

TO-268 (IXFT)

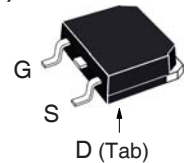

TO-247 (IXFH)

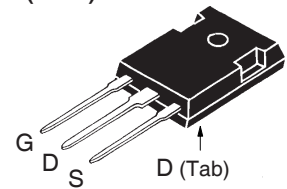

G = Gate D = Drain
 S = Source Tab = Drain

Symbol	Test Conditions	Maximum Ratings	
V_{DSS}	$T_J = 25^\circ C$ to $150^\circ C$	1000	V
V_{DGR}	$T_J = 25^\circ C$ to $150^\circ C$, $R_{GS} = 1M\Omega$	1000	V
V_{GSS}	Continuous	± 30	V
V_{GSM}	Transient	± 40	V
I_{D25}	$T_C = 25^\circ C$	18	A
I_{DM}	$T_C = 25^\circ C$, Pulse Width Limited by T_{JM}	60	A
I_A	$T_C = 25^\circ C$	18	A
E_{AS}	$T_C = 25^\circ C$	1.5	J
dv/dt	$I_S \leq I_{DM}$, $V_{DD} \leq V_{DSS}$, $T_J \leq 150^\circ C$	50	V/ns
P_D	$T_C = 25^\circ C$	830	W
T_J		-55 ... +150	$^\circ C$
T_{JM}		150	$^\circ C$
T_{stg}		-55 ... +150	$^\circ C$
T_L	1.6mm (0.062in.) from Case for 10s	300	$^\circ C$
T_{sold}	Plastic Body for 10 seconds	260	$^\circ C$
M_d	Mounting Torque (TO-247)	1.13 / 10	Nm/lb.in.
Weight	TO-268	4.0	g
	TO-247	6.0	g

Symbol	Test Conditions ($T_J = 25^\circ C$ Unless Otherwise Specified)	Characteristic Values		
		Min.	Typ.	Max.
BV_{DSS}	$V_{GS} = 0V$, $I_D = 1mA$	1000		V
$V_{GS(th)}$	$V_{DS} = V_{GS}$, $I_D = 4mA$	3.5		6.5 V
I_{GSS}	$V_{GS} = \pm 30V$, $V_{DS} = 0V$			± 100 nA
I_{DSS}	$V_{DS} = V_{DSS}$, $V_{GS} = 0V$ $T_J = 125^\circ C$			25 μA 1.25 mA
$R_{DS(on)}$	$V_{GS} = 10V$, $I_D = 0.5 \cdot I_{D25}$, Note 1			660 m Ω

Features

- Low Intrinsic Gate Resistance
- International Standard Packages
- Low Package Inductance
- Fast Intrinsic Rectifier
- Low $R_{DS(on)}$ and Q_G

Advantages

- High Power Density
- Easy to Mount
- Space Savings

Applications

- DC-DC Converters
- Battery Chargers
- Switch-Mode and Resonant-Mode Power Supplies
- DC Choppers
- Temperature and Lighting Controls

Symbol	Test Conditions ($T_J = 25^\circ\text{C}$ Unless Otherwise Specified)	Characteristic Values		
		Min.	Typ.	Max.
g_{fs}	$V_{DS} = 20\text{V}, I_D = 0.5 \cdot I_{D25}$, Note 1	9	16	S
C_{iss}	$V_{GS} = 0\text{V}, V_{DS} = 25\text{V}, f = 1\text{MHz}$		4890	pF
C_{oss}			400	pF
C_{rss}			34	pF
R_{Gi}	Gate Input Resistance		0.20	Ω
$t_{d(on)}$	Resistive Switching Times $V_{GS} = 10\text{V}, V_{DS} = 0.5 \cdot V_{DSS}, I_D = 0.5 \cdot I_{D25}$ $R_G = 3\Omega$ (External)		37	ns
t_r			32	ns
$t_{d(off)}$			40	ns
t_f			13	ns
$Q_{g(on)}$	$V_{GS} = 10\text{V}, V_{DS} = 0.5 \cdot V_{DSS}, I_D = 0.5 \cdot I_{D25}$		90	nC
Q_{gs}			33	nC
Q_{gd}			37	nC
R_{thJC}			0.15	$^\circ\text{C/W}$
R_{thCS}	TO-247	0.21		$^\circ\text{C/W}$

Source-Drain Diode

Symbol	Test Conditions ($T_J = 25^\circ\text{C}$ Unless Otherwise Specified)	Characteristic Values		
		Min.	Typ.	Max.
I_s	$V_{GS} = 0\text{V}$			18 A
I_{SM}	Repetitive, Pulse Width Limited by T_{JM}			72 A
V_{SD}	$I_F = I_s, V_{GS} = 0\text{V}$, Note 1			1.4 V
t_{rr}	$I_F = 9\text{A}, -di/dt = 100\text{A}/\mu\text{s}$ $V_R = 100\text{V}, V_{GS} = 0\text{V}$			300 ns
I_{RM}			11.0	A
Q_{RM}			1.5	μC

Note 1. Pulse test, $t \leq 300\mu\text{s}$, duty cycle, $d \leq 2\%$.

ADVANCE TECHNICAL INFORMATION

The product presented herein is under development. The Technical Specifications offered are derived from a subjective evaluation of the design, based upon prior knowledge and experience, and constitute a "considered reflection" of the anticipated result. IXYS reserves the right to change limits, test conditions, and dimensions without notice.

TO-268 Outline

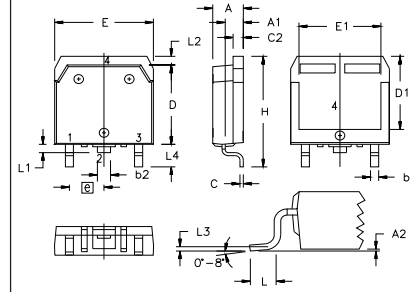

Terminals: 1 - Gate, 2,4 - Drain, 3 - Source

SYM	INCHES		MILLIMETERS	
	MIN	MAX	MIN	MAX
A	.193	.201	4.90	5.10
A1	.106	.114	2.70	2.90
A2	.001	.010	0.02	0.25
b	.045	.057	1.15	1.45
b2	.075	.083	1.90	2.10
C	.016	.026	0.40	0.65
C2	.057	.063	1.45	1.60
D	.543	.551	13.80	14.00
D1	.488	.500	12.40	12.70
E	.624	.632	15.85	16.05
E1	.524	.535	13.30	13.60
e	.215 BSC		5.45 BSC	
H	.736	.752	18.70	19.10
L	.094	.106	2.40	2.70
L1	.047	.055	1.20	1.40
L2	.039	.045	1.00	1.15
L3	.010 BSC		0.25 BSC	
L4	.150	.161	3.80	4.10

TO-247 Outline

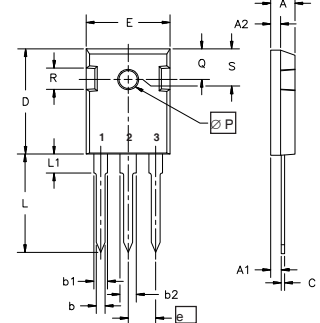

Terminals: 1 - Gate, 2 - Drain, 3 - Source

Dim.	Millimeter		Inches	
	Min.	Max.	Min.	Max.
A	4.7	5.3	.185	.209
A ₁	2.2	2.54	.087	.102
A ₂	2.2	2.6	.059	.098
b	1.0	1.4	.040	.055
b ₁	1.65	2.13	.065	.084
b ₂	2.87	3.12	.113	.123
C	.4	.8	.016	.031
D	20.80	21.46	.819	.845
E	15.75	16.26	.610	.640
e	5.20	5.72	0.205	0.225
L	19.81	20.32	.780	.800
L1		4.50		.177
∅P	3.55	3.65	.140	.144
Q	5.89	6.40	0.232	0.252
R	4.32	5.49	.170	.216
S	6.15 BSC		242 BSC	

IXYS Reserves the Right to Change Limits, Test Conditions, and Dimensions.

IXYS MOSFETs and IGBTs are covered by one or more of the following U.S. patents:

4,835,592	4,931,844	5,049,961	5,237,481	6,162,665	6,404,065 B1	6,683,344	6,727,585	7,005,734 B2	7,157,338B2
4,850,072	5,017,508	5,063,307	5,381,025	6,259,123 B1	6,534,343	6,710,405 B2	6,759,692	7,063,975 B2	
4,881,106	5,034,796	5,187,117	5,486,715	6,306,728 B1	6,583,505	6,710,463	6,771,478 B2	7,071,537	

Fig. 1. Output Characteristics @ $T_J = 25^\circ\text{C}$

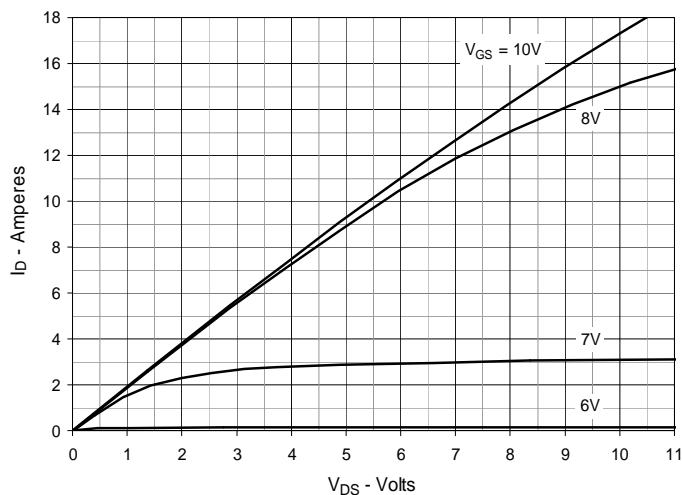

Fig. 2. Extended Output Characteristics @ $T_J = 25^\circ\text{C}$

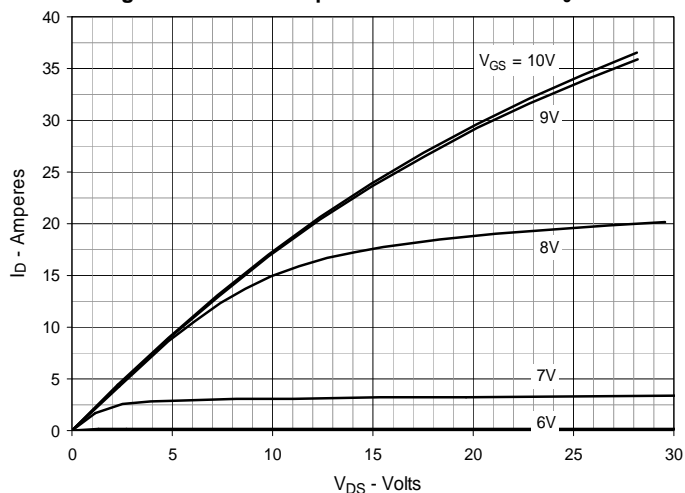

Fig. 3. Output Characteristics @ $T_J = 125^\circ\text{C}$

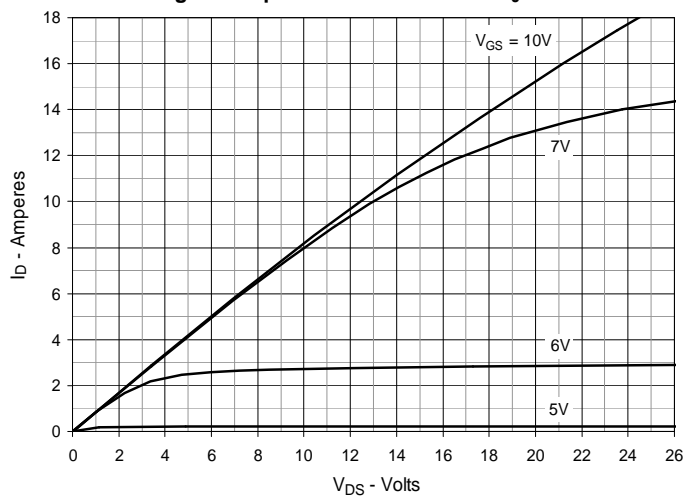

Fig. 4. $R_{DS(on)}$ Normalized to $I_D = 9\text{A}$ Value vs. Junction Temperature

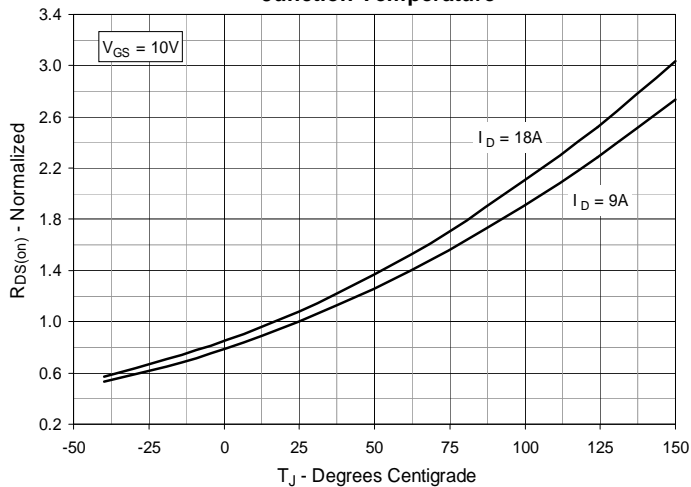

Fig. 5. $R_{DS(on)}$ Normalized to $I_D = 9\text{A}$ Value vs. Drain Current

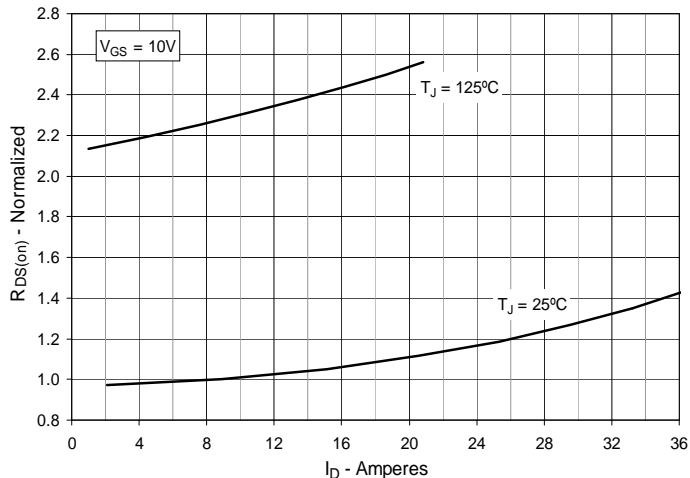

Fig. 6. Maximum Drain Current vs. Case Temperature

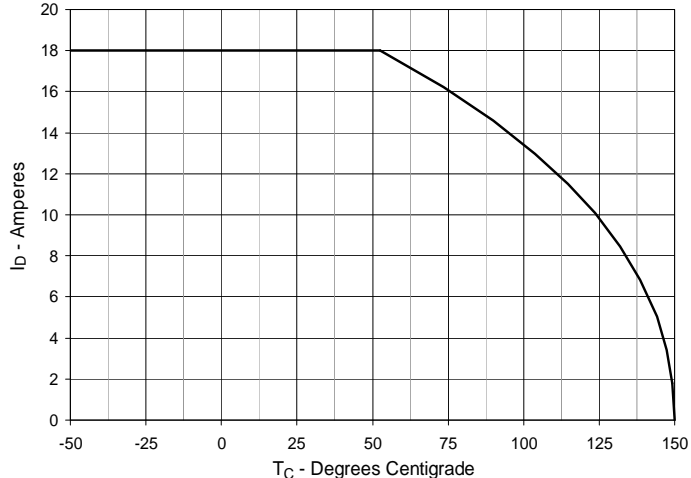

Fig. 7. Input Admittance

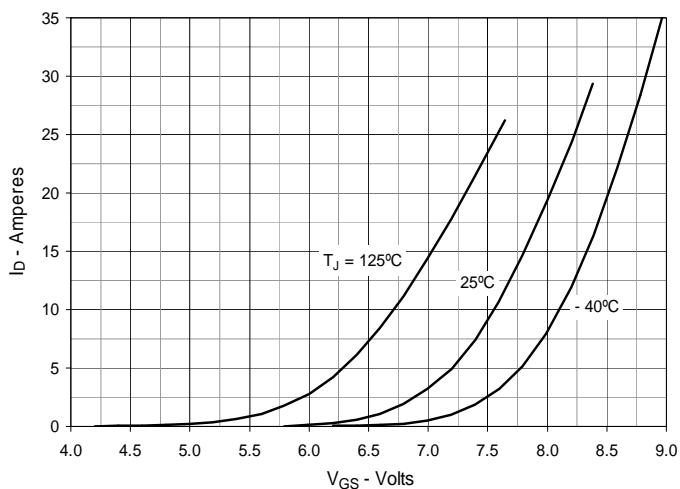

Fig. 8. Transconductance

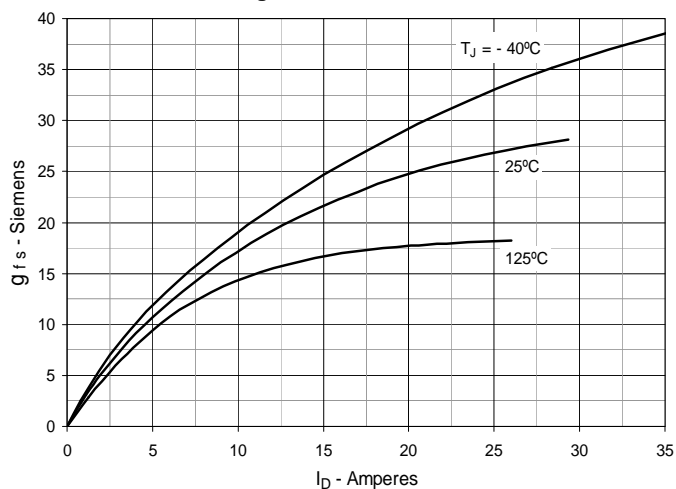

Fig. 9. Forward Voltage Drop of Intrinsic Diode

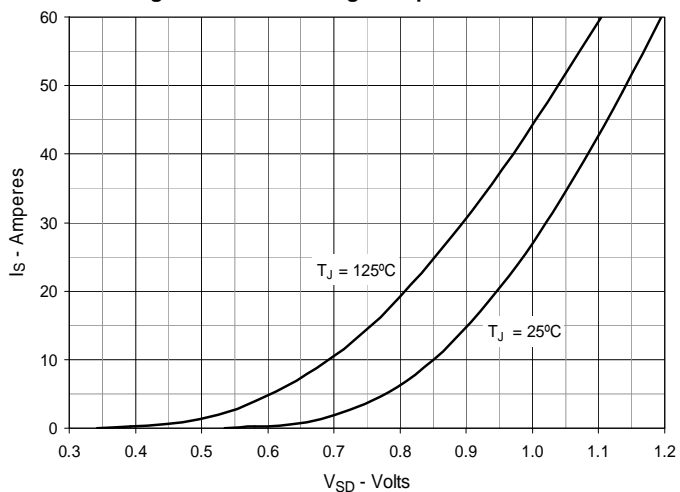

Fig. 10. Gate Charge

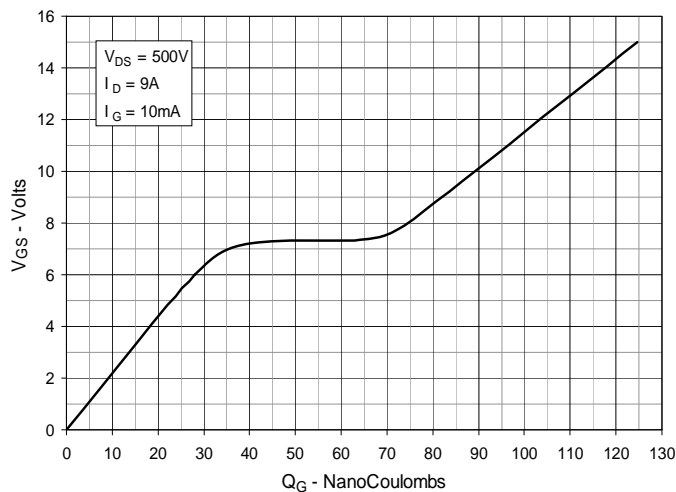

Fig. 11. Capacitance

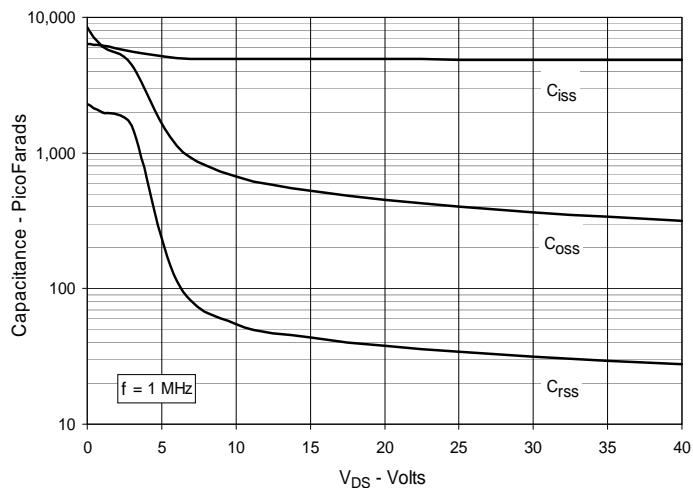

Fig. 12. Forward-Bias Safe Operating Area

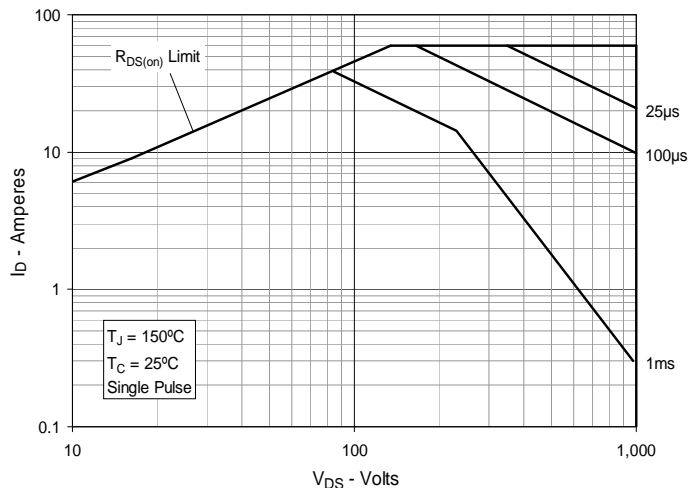

Fig. 13 Maximum Transient Thermal Impedance

