

High Voltage IGBT For Capacitor Discharge Applications

IXGF25N250

$$V_{CES} = 2500V$$

$$I_{C25} = 30A$$

$$V_{CE(sat)} \leq 2.9V$$

(Electrically Isolated Tab)

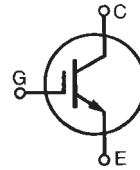

ISOPLUS i4-Pak™

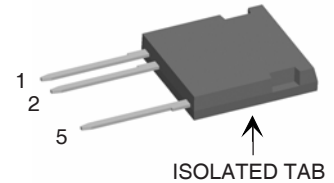

1 = Gate
2 = Emitter
5 = Collector

Symbol	Test Conditions	Maximum Ratings	
V_{CES}	$T_J = 25^\circ C$ to $150^\circ C$	2500	V
V_{CGR}	$T_J = 25^\circ C$ to $150^\circ C$, $R_{GE} = 1M\Omega$	2500	V
V_{GES}	Continuous	± 20	V
V_{GEM}	Transient	± 30	V
I_{C25}	$T_C = 25^\circ C$	30	A
I_{C110}	$T_C = 110^\circ C$	15	A
I_{CM}	$T_C = 25^\circ C$, $V_{GE} = 20V$, 1ms	200	A
SSOA (RBSOA)	$V_{GE} = 20V$, $T_{VJ} = 125^\circ C$, $R_G = 20\Omega$ Clamped Inductive Load	$I_{CM} = 240$ $0.5 \cdot V_{CES}$	A
P_C	$T_C = 25^\circ C$	114	W
T_J		-55 ... +150	$^\circ C$
T_{JM}		150	$^\circ C$
T_{stg}		-55 ... +150	$^\circ C$
T_L	1.6 mm (0.062 in.) from Case for 10s	300	$^\circ C$
T_{SOLD}	Plastic Body for 10s	260	$^\circ C$
F_C	Mounting Force	20..120/4.5..27	Nm/lbin.
V_{ISOL}	50/60Hz, 1 minute	2500	V~
Weight		5	g

Features

- UL Recognized Package
- Electrically Isolated Tab
- High Peak Current Capability
- Low Saturation Voltage
- MOS Gate Turn-On
- Drive Simplicity
- Rugged NPT Structure
- Molding Epoxies Meet UL 94 V-0 Flammability Classification

Applications

- Capacitor Discharge
- Pulser Circuits

Advantages

- High Power Density
- Easy to Mount

Symbol	Test Conditions ($T_J = 25^\circ C$, Unless Otherwise Specified)	Characteristic Values		
		Min.	Typ.	Max.
BV_{CES}	$I_C = 250\mu A$, $V_{GE} = 0V$	2500		V
$V_{GE(th)}$	$I_C = 250\mu A$, $V_{CE} = V_{GE}$	3.0		5.0 V
I_{CES}	$V_{CE} = 0.8 \cdot V_{CES}$, $V_{GE} = 0V$, Note 2 $T_J = 125^\circ C$			50 μA 1 mA
I_{GES}	$V_{CE} = 0V$, $V_{GE} = \pm 20V$			± 100 nA
$V_{CE(sat)}$	$I_C = 25A$, $V_{GE} = 15V$, Note 1 $I_C = 75A$			2.9 V 5.2 V

Symbol	Test Conditions ($T_J = 25^\circ\text{C}$, Unless Otherwise Specified)	Characteristic Values		
		Min.	Typ.	Max.
g_{fs}	$I_C = 50\text{A}$, $V_{CE} = 10\text{V}$, Note 1	16	26	S
$I_{C(ON)}$	$V_{GE} = 15\text{V}$, $V_{CE} = 20\text{V}$, Note 1		240	A
C_{ies}	$V_{CE} = 25\text{V}$, $V_{GE} = 0\text{V}$, $f = 1\text{MHz}$		2970	pF
C_{oes}			98	pF
C_{res}			36	pF
Q_g	$I_C = 50\text{A}$, $V_{GE} = 15\text{V}$, $V_{CE} = 0.5 \cdot V_{CES}$		75	nC
Q_{ge}			15	nC
Q_{gc}			30	nC
$t_{d(on)}$	Resistive Switching Times $I_C = 50\text{A}$, $V_{GE} = 15\text{V}$ $V_{CE} = 1250\text{V}$, $R_G = 5\Omega$		68	ns
t_r			233	ns
$t_{d(off)}$			209	ns
t_f			200	ns
R_{thJC}				1.10 °C/W
R_{thCS}		0.15		°C/W
R_{thJA}		30		°C/W

ISOPLUS i4-Pak™ (HV) (IXGF) Outline

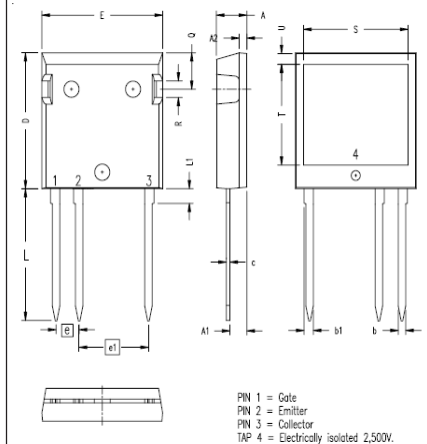

SYM	INCHES		MILLIMETERS	
	MIN	MAX	MIN	MAX
A	.190	.205	4.83	5.21
A1	.102	.118	2.59	3.00
A2	.046	.085	1.17	2.16
b	.045	.055	1.14	1.40
b1	.058	.068	1.47	1.73
C	.020	.029	0.51	0.74
D	.819	.840	20.80	21.34
E	.770	.799	19.56	20.29
e	.150 BSC		3.81 BSC	
e1	.450 BSC		11.43 BSC	
L	.780	.840	19.81	21.34
L1	.083	.102	2.11	2.59
Q	.210	.244	5.33	6.20
R	.100	.180	2.54	4.57
S	.660	.690	16.76	17.53
T	.590	.620	14.99	15.75
U	.065	.080	1.65	2.03

- Notes: 1. Pulse Test, $t < 300\mu\text{s}$; Duty Cycle, $d < 2\%$.
2. Device must be heatsunk for high temperature leakage current measurements to avoid thermal runaway.

IXYS Reserves the Right to Change Limits, Test Conditions, and Dimensions.

IXYS MOSFETs and IGBTs are covered by one or more of the following U.S. patents:	4,835,592	4,931,844	5,049,961	5,237,481	6,162,665	6,404,065 B1	6,683,344	6,727,585	7,005,734 B2	7,157,338B2
	4,850,072	5,017,508	5,063,307	5,381,025	6,259,123 B1	6,534,343	6,710,405 B2	6,759,692	7,063,975 B2	
	4,881,106	5,034,796	5,187,117	5,486,715	6,306,728 B1	6,583,505	6,710,463	6,771,478 B2	7,071,537	

Fig. 1. Output Characteristics @ 25°C

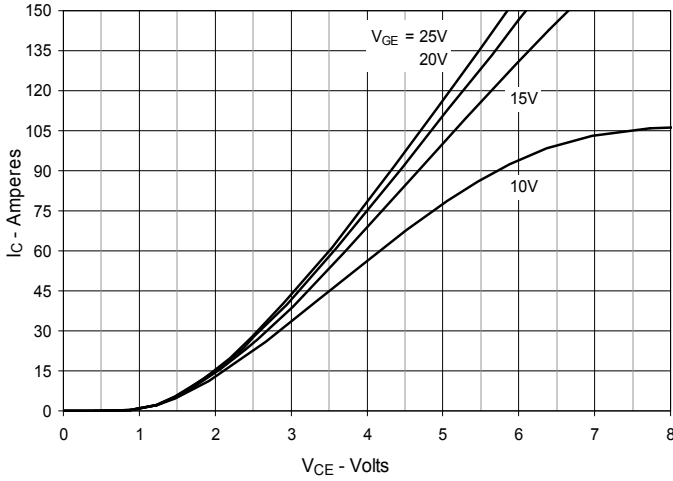

Fig. 2. Extended Output Characteristics @ 25°C

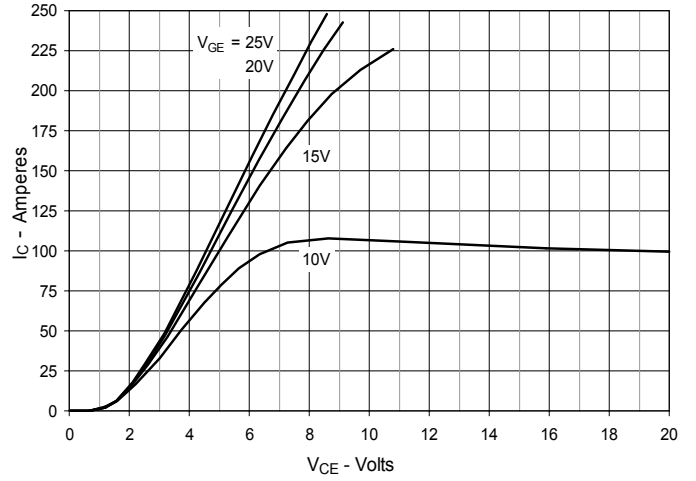

Fig. 3. Output Characteristics @ 125°C

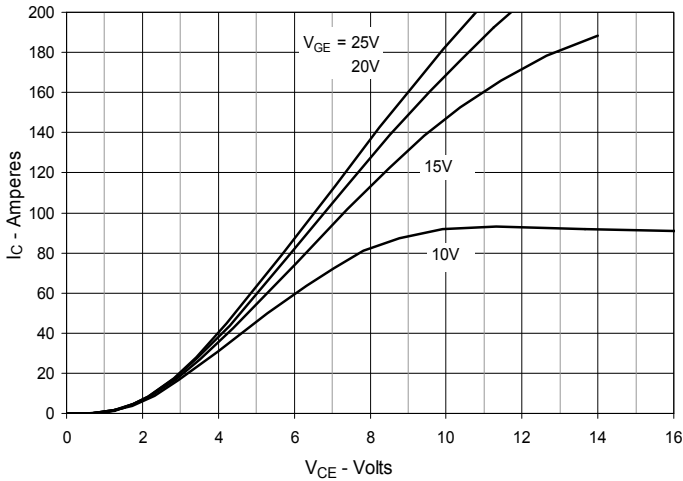

Fig. 4. Dependence of $V_{CE(sat)}$ on Junction Temperature

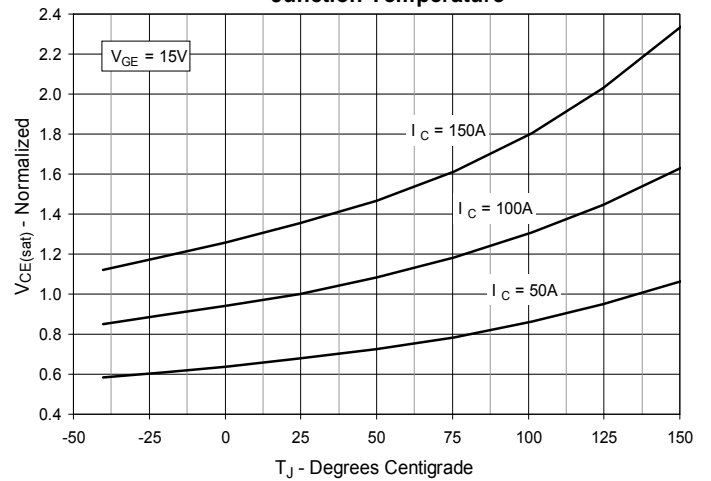

Fig. 5. Collector-to-Emitter Voltage vs. Gate-to-Emitter Voltage

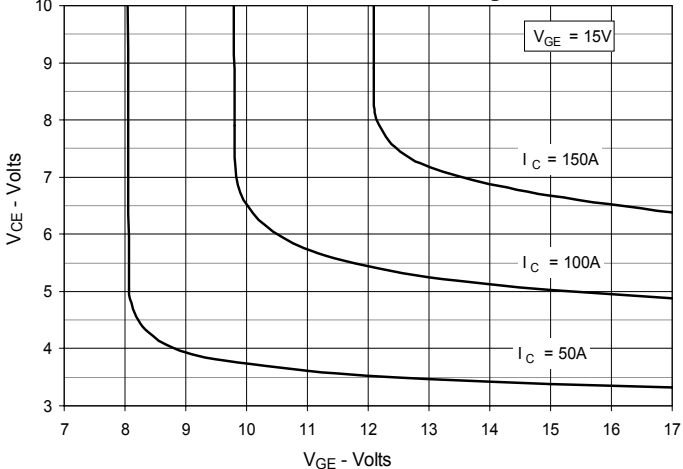

Fig. 6. Input Admittance

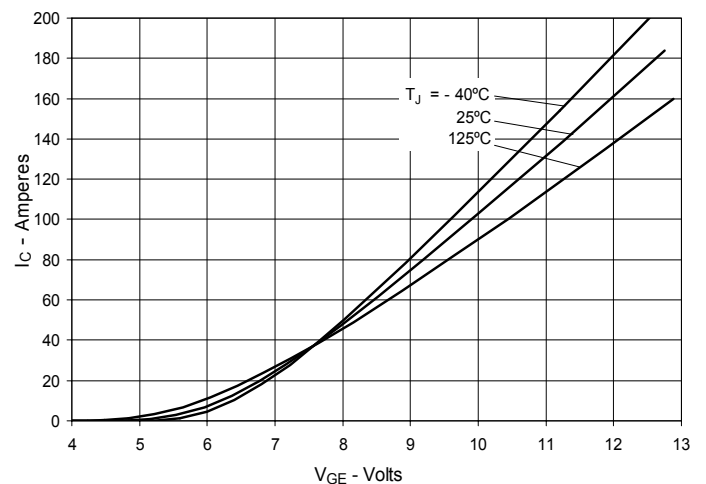

Fig. 7. Transconductance

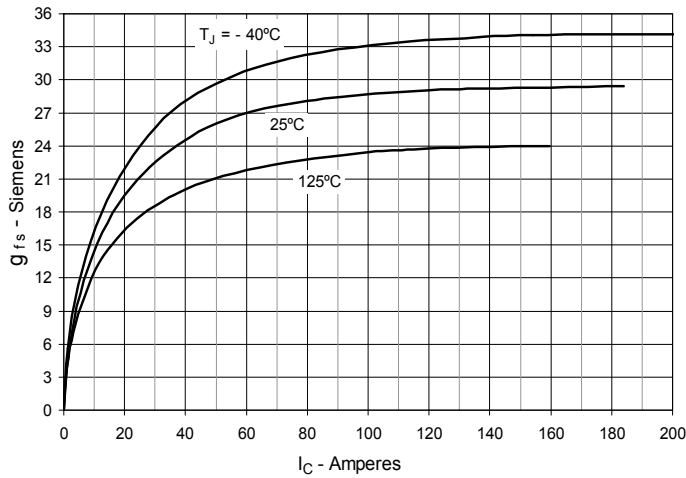

Fig. 8. Gate Charge

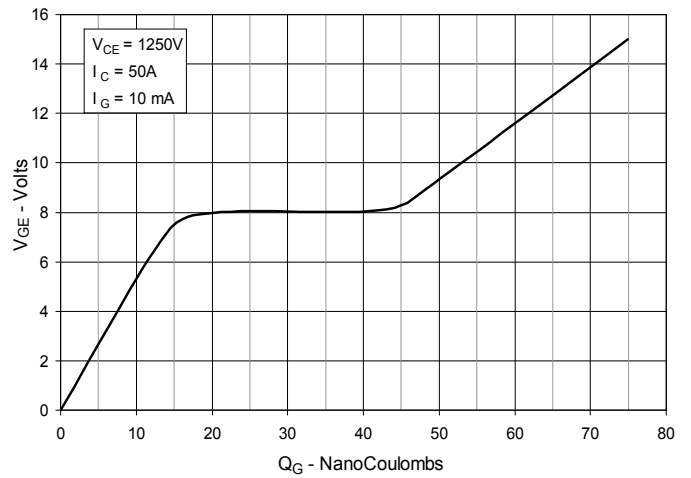

Fig. 9. Reverse-Bias Safe Operating Area

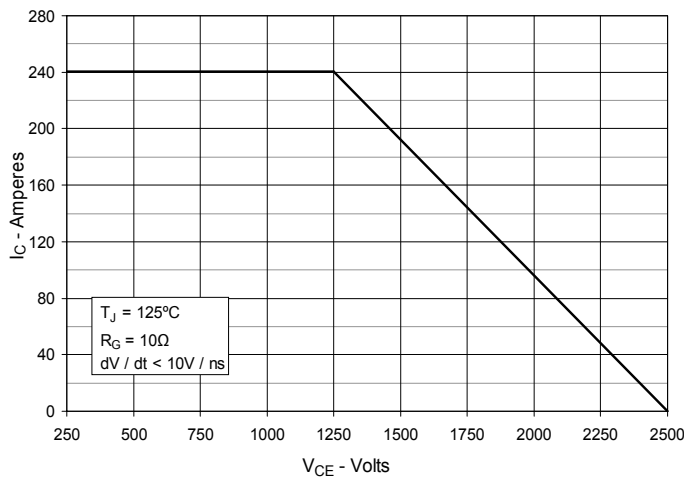

Fig. 10. Capacitance

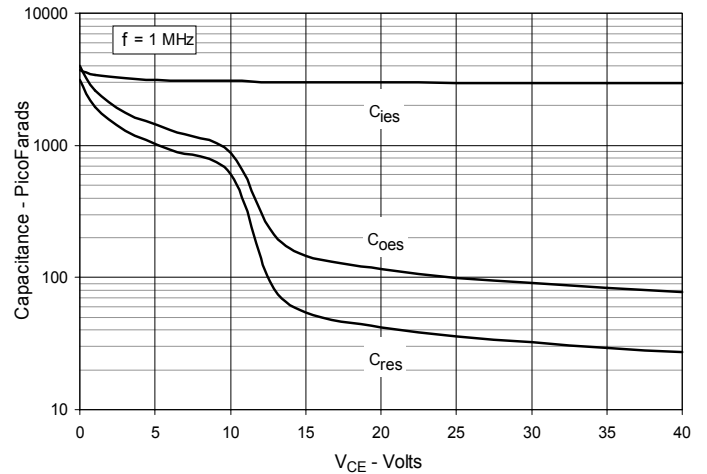

Fig. 11. Maximum Transient Thermal Impedance

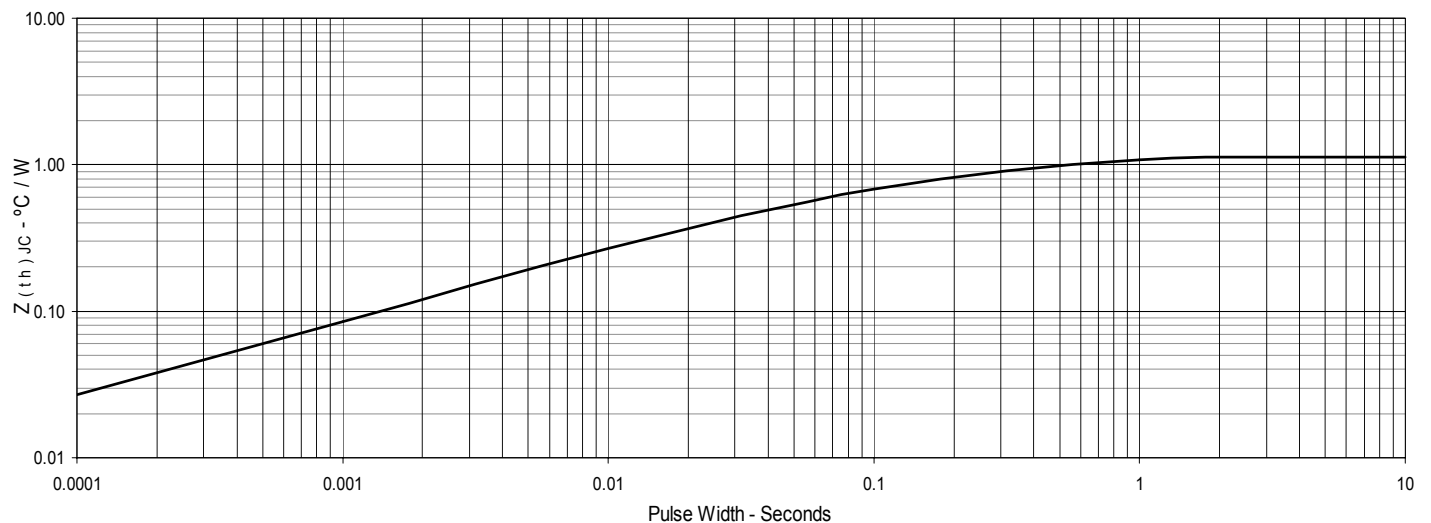

Fig. 12. Resistive Turn-on Rise Time vs. Junction Temperature

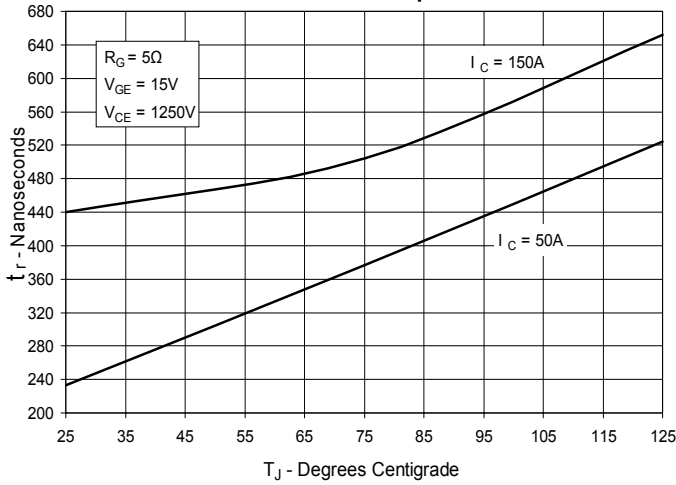

Fig. 13. Resistive Turn-on Rise Time vs. Collector Current

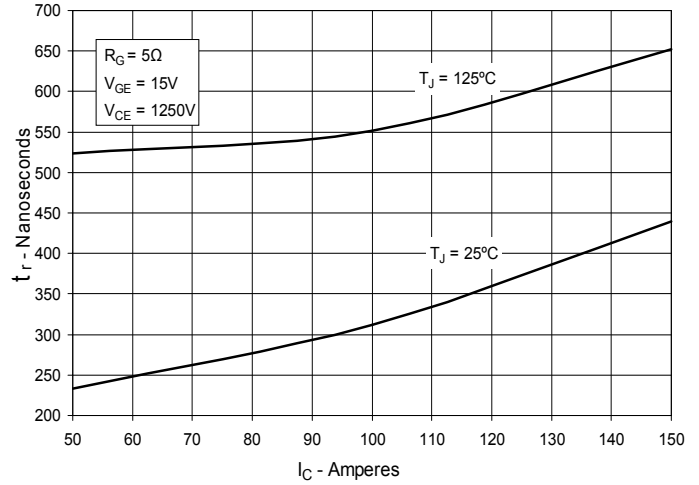

Fig. 14. Resistive Turn-on Switching Times vs. Gate Resistance

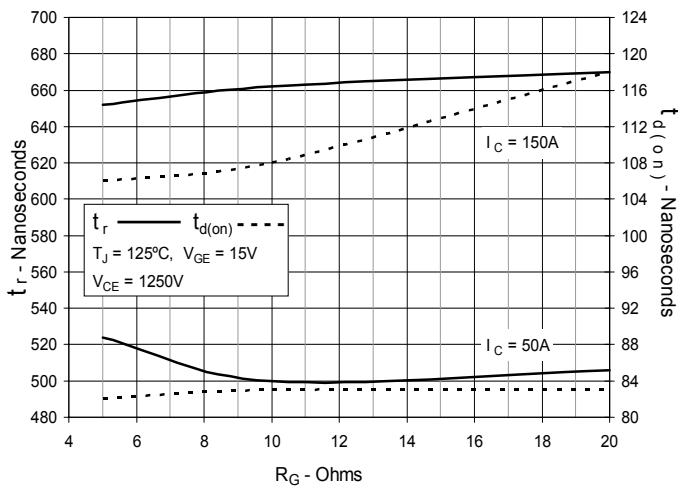

Fig. 15. Resistive Turn-off Switching Times vs. Junction Temperature

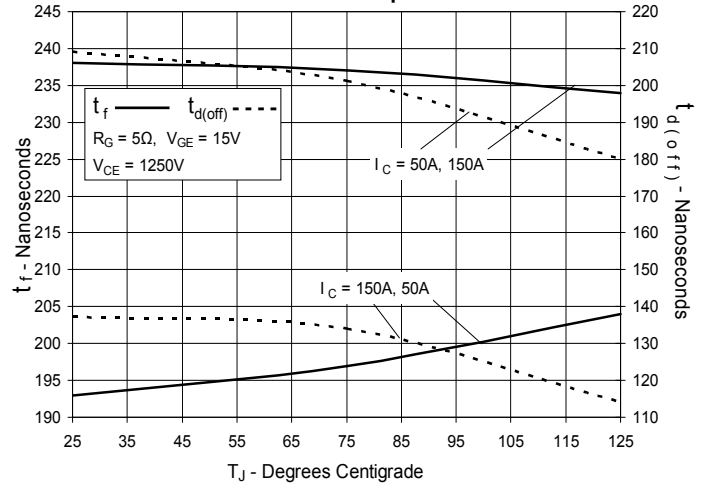

Fig. 16. Resistive Turn-off Switching Times vs. Collector Current

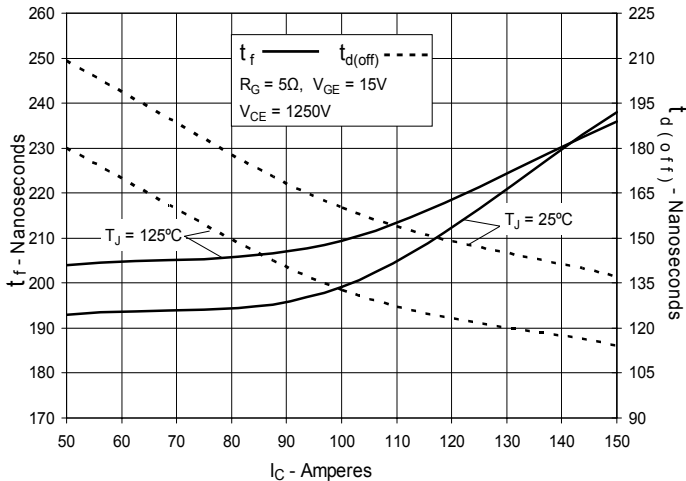

Fig. 17. Resistive Turn-off Switching Times vs. Gate Resistance

