

High Voltage IGBT

IXGF32N170

(Electrically Isolated Tab)

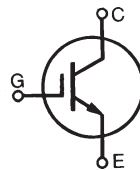

$V_{CES} = 1700V$
 $I_{C110} = 19A$
 $V_{CE(sat)} \leq 3.5V$
 $t_{fi(typ)} = 250ns$

ISOPLUS i4-Pak™

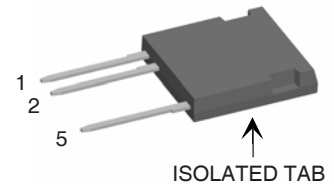

1 = Gate
2 = Emitter
5 = Collector

| Symbol | Test Conditions | Maximum Ratings | |
|----------------|--|-----------------------|------------|
| V_{CES} | $T_J = 25^\circ C$ to $150^\circ C$ | 1700 | V |
| V_{GES} | Continuous | ± 20 | V |
| V_{GEM} | Transient | ± 30 | V |
| I_{C25} | $T_C = 25^\circ C$ | 44 | A |
| I_{C110} | $T_C = 110^\circ C$ | 19 | A |
| I_{CM} | $T_C = 25^\circ C$, 1ms | 200 | A |
| SSOA | $V_{GE} = 15V$, $T_{VJ} = 125^\circ C$, $R_G = 2.7\Omega$ | $I_{CM} = 70$ | A |
| (RBSOA) | Clamped Inductive Load | @ $0.8 \cdot V_{CES}$ | |
| t_{sc} | $T_C = 125^\circ C$, $V_{CE} = 1200V$, $V_{GE} = 15V$, $R_G = 10\Omega$ | 10 | μs |
| P_C | $T_C = 25^\circ C$ | 200 | W |
| T_J | | -55 ... +150 | $^\circ C$ |
| T_{JM} | | 150 | $^\circ C$ |
| T_{stg} | | -55 ... +150 | $^\circ C$ |
| T_L | 1.6 mm (0.062 in.) from Case for 10s | 300 | $^\circ C$ |
| T_{SOLD} | Plastic Body for 10s | 260 | $^\circ C$ |
| F_C | Mounting Force | 20..120 / 4.5..27 | Nm/lb.in. |
| V_{ISOL} | 50/60Hz, 1 minute | 2500 | V~ |
| Weight | | 5 | g |

Features

- Electrically Isolated Tab
- High Current Handling Capability
- Rugged NPT Structure
- Molding Epoxies Meet UL 94 V-0 Flammability Classification

Applications

- Capacitor Discharge & Pulser Circuits
- AC Motor Drives
- Uninterruptible Power Supplies (UPS)
- Switched-Mode and Resonant-Mode Power Supplies

Advantages

- High Power Density
- Suitable for Surface Mounting

| Symbol | Test Conditions ($T_J = 25^\circ C$, Unless Otherwise Specified) | Characteristic Values | | |
|---------------|--|-----------------------|------|--------------------|
| | | Min. | Typ. | Max. |
| BV_{CES} | $I_C = 1mA$, $V_{GE} = 0V$ | 1700 | | V |
| $V_{GE(th)}$ | $I_C = 250\mu A$, $V_{CE} = V_{GE}$ | 3.0 | | 5.0 V |
| I_{CES} | $V_{CE} = 0.8 \cdot V_{CES}$, $V_{GE} = 0V$, Note 2 $T_J = 125^\circ C$ | | | 50 μA 1 mA |
| I_{GES} | $V_{CE} = 0V$, $V_{GE} = \pm 20V$ | | | ± 100 nA |
| $V_{CE(sat)}$ | $I_C = 32A$, $V_{GE} = 15V$, Note 1 $T_J = 125^\circ C$ | 2.7 3.3 | 3.5 | V V |

| Symbol | Test Conditions ($T_J = 25^\circ\text{C}$, Unless Otherwise Specified) | Characteristic Values | | |
|--------------|---|-----------------------|------|-----------|
| | | Min. | Typ. | Max. |
| g_{fs} | $I_C = 32\text{A}$, $V_{CE} = 10\text{V}$, Note 1 | 20 | 30 | S |
| C_{ies} | $V_{CE} = 25\text{V}$, $V_{GE} = 0\text{V}$, $f = 1\text{MHz}$ | | 4290 | pF |
| C_{oes} | | | 167 | pF |
| C_{res} | | | 47 | pF |
| Q_g | $I_C = 32\text{A}$, $V_{GE} = 15\text{V}$, $V_{CE} = 0.5 \cdot V_{CES}$ | | 146 | nC |
| Q_{ge} | | | 28 | nC |
| Q_{gc} | | | 52 | nC |
| $t_{d(on)}$ | Inductive load, $T_J = 25^\circ\text{C}$ $I_C = 32\text{A}$, $V_{GE} = 15\text{V}$ $V_{CE} = 0.6 \cdot V_{CES}$, $R_G = 2.7\Omega$ | | 45 | ns |
| t_{ri} | | | 38 | ns |
| $t_{d(off)}$ | | | 270 | 500 ns |
| t_{fi} | | | 250 | 500 ns |
| E_{off} | | | 10.6 | 20 mJ |
| $t_{d(on)}$ | Inductive load, $T_J = 125^\circ\text{C}$ $I_C = 32\text{A}$, $V_{GE} = 15\text{V}$ $V_{CE} = 0.6 \cdot V_{CES}$, $R_G = 2.7\Omega$ | | 48 | ns |
| t_{ri} | | | 42 | ns |
| E_{off} | | | 6.0 | mJ |
| $t_{d(off)}$ | | | 360 | ns |
| t_{fi} | | | 560 | ns |
| E_{off} | | 13.5 | mJ | |
| R_{thJC} | | | | 0.62 °C/W |
| R_{thCS} | | 0.15 | | °C/W |
| R_{thJA} | | 30 | | °C/W |

ISOPLUS i4-Pak™ (HV) (IXGF) Outline

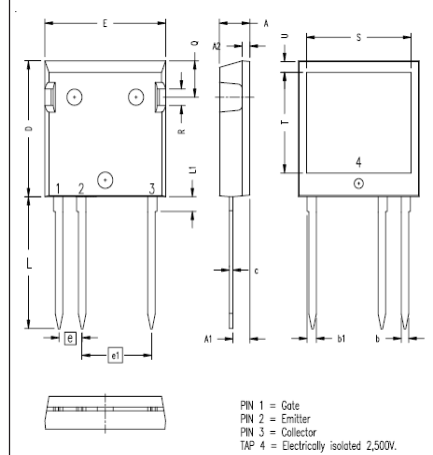

| SYM | INCHES | | MILLIMETERS | |
|-----|----------|------|-------------|-------|
| | MIN | MAX | MIN | MAX |
| A | .190 | .205 | 4.83 | 5.21 |
| A1 | .102 | .118 | 2.59 | 3.00 |
| A2 | .046 | .085 | 1.17 | 2.16 |
| b | .045 | .055 | 1.14 | 1.40 |
| b1 | .058 | .068 | 1.47 | 1.73 |
| C | .020 | .029 | 0.51 | 0.74 |
| D | .819 | .840 | 20.80 | 21.34 |
| E | .770 | .799 | 19.56 | 20.29 |
| e | .150 BSC | | 3.81 BSC | |
| e1 | .450 BSC | | 11.43 BSC | |
| L | .780 | .840 | 19.81 | 21.34 |
| L1 | .083 | .102 | 2.11 | 2.59 |
| Q | .210 | .244 | 5.33 | 6.20 |
| R | .100 | .180 | 2.54 | 4.57 |
| S | .660 | .690 | 16.76 | 17.53 |
| T | .590 | .620 | 14.99 | 15.75 |
| U | .065 | .080 | 1.65 | 2.03 |

- Notes: 1. Pulse test, $t < 300\mu\text{s}$; duty cycle, $d < 2\%$.
 2. Device must be heatsunk for high temperature leakage current measurements to avoid thermal runaway.

IXYS Reserves the Right to Change Limits, Test Conditions, and Dimensions.

| | | | | | | | | | | |
|--|-----------|-----------|-----------|-----------|--------------|--------------|--------------|--------------|--------------|-------------|
| IXYS MOSFETs and IGBTs are covered by one or more of the following U.S. patents: | 4,835,592 | 4,931,844 | 5,049,961 | 5,237,481 | 6,162,665 | 6,404,065 B1 | 6,683,344 | 6,727,585 | 7,005,734 B2 | 7,157,338B2 |
| | 4,850,072 | 5,017,508 | 5,063,307 | 5,381,025 | 6,259,123 B1 | 6,534,343 | 6,710,405 B2 | 6,759,692 | 7,063,975 B2 | |
| | 4,881,106 | 5,034,796 | 5,187,117 | 5,486,715 | 6,306,728 B1 | 6,583,505 | 6,710,463 | 6,771,478 B2 | 7,071,537 | |

Fig. 1. Output Characteristics @ 25°C

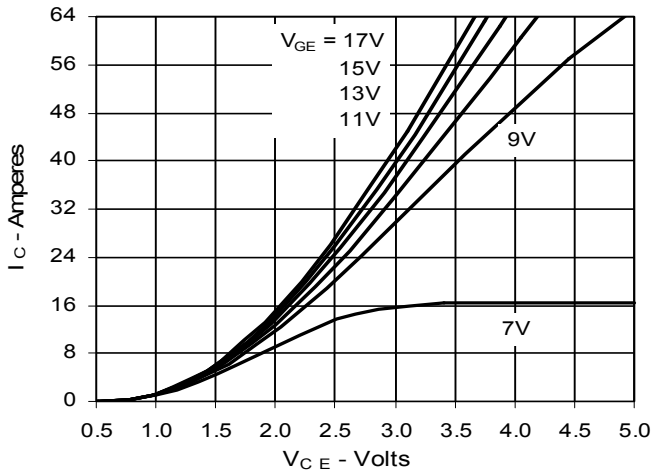

Fig. 2. Extended Output Characteristics @ 25°C

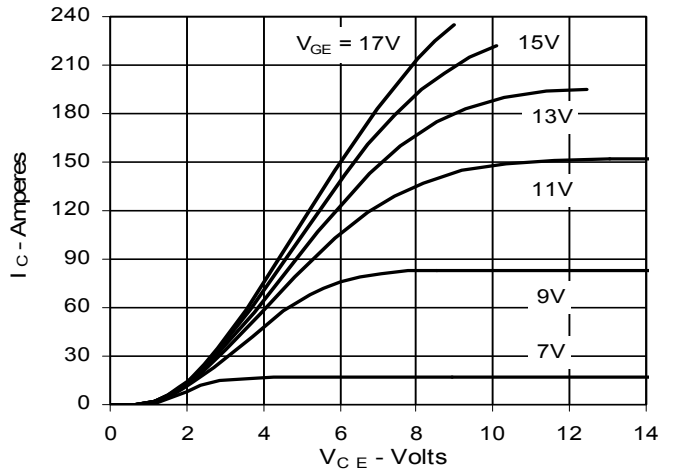

Fig. 3. Output Characteristics @ 125°C

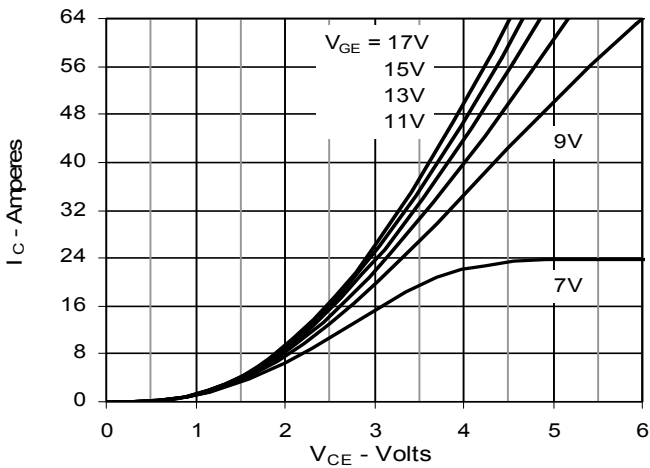

Fig. 4. Dependence of $V_{CE(sat)}$ on Temperature

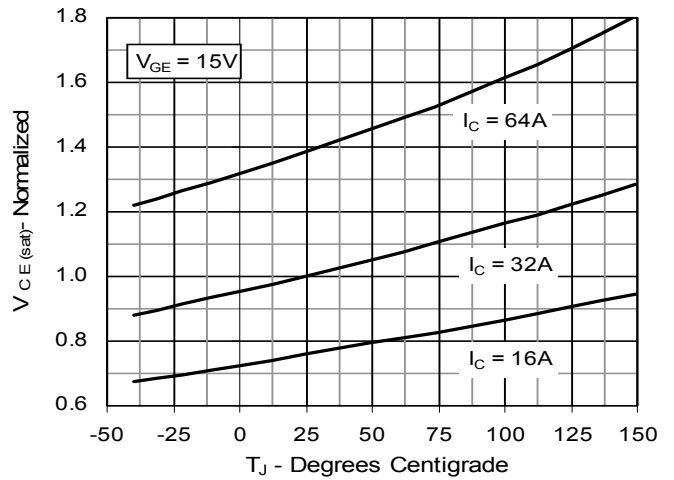

Fig. 5. Collector-to-Emitter Voltage vs. Gate-to-Emitter voltage

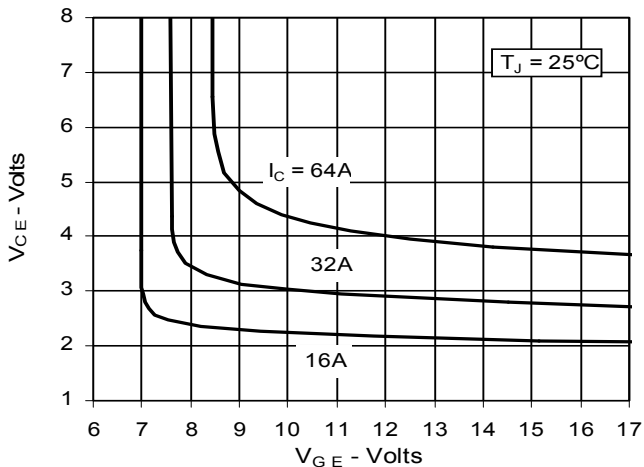

Fig. 6. Input Admittance

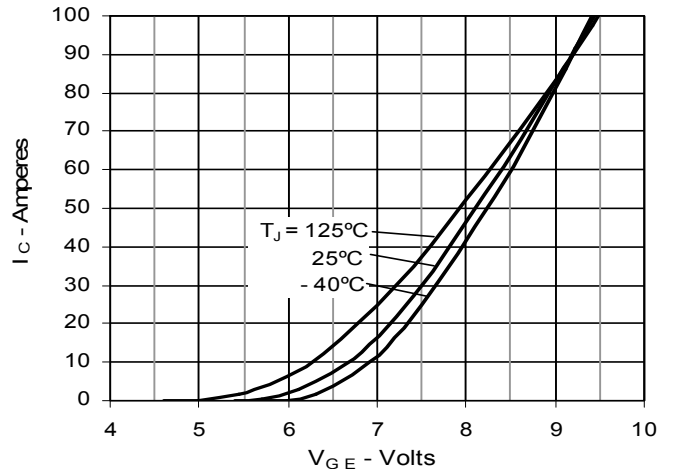

Fig. 7. Transconductance

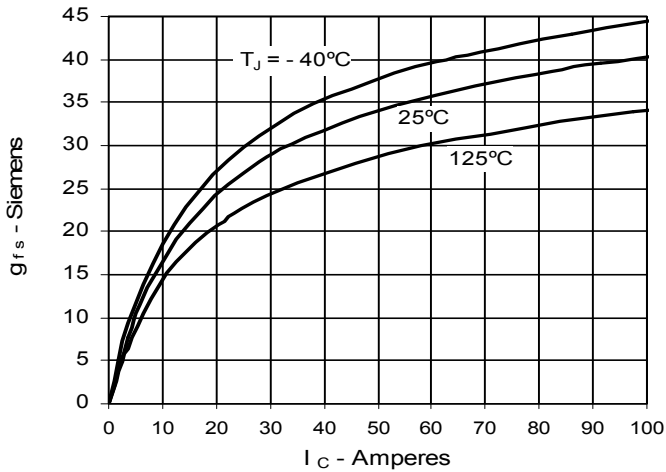

Fig. 8. Gate Charge

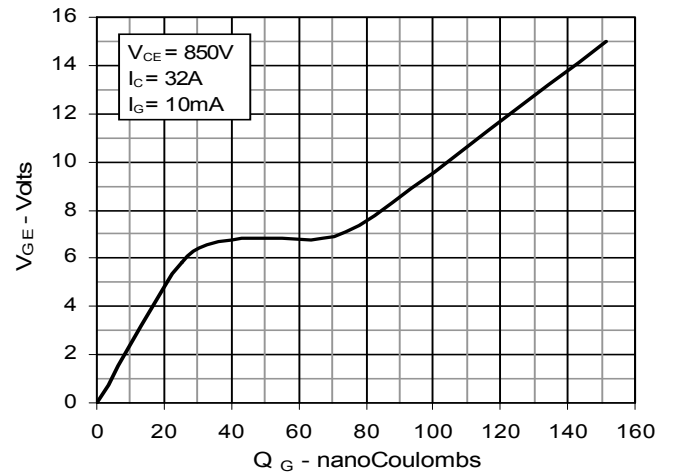

Fig. 9. Capacitance

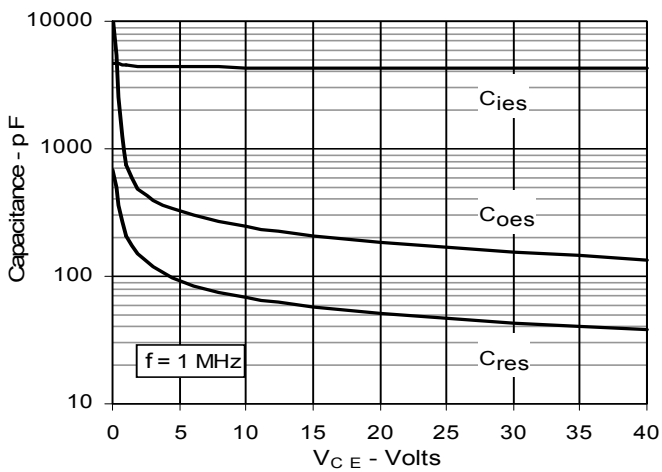

Fig. 10. Dependence of E_{off} on R_G

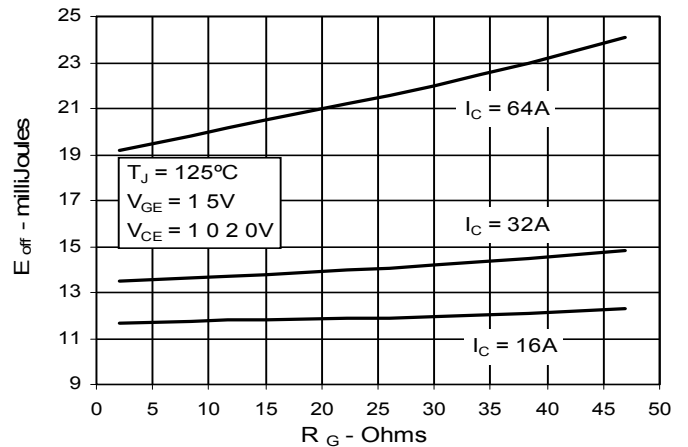

Fig. 11. Dependence of E_{off} on I_C

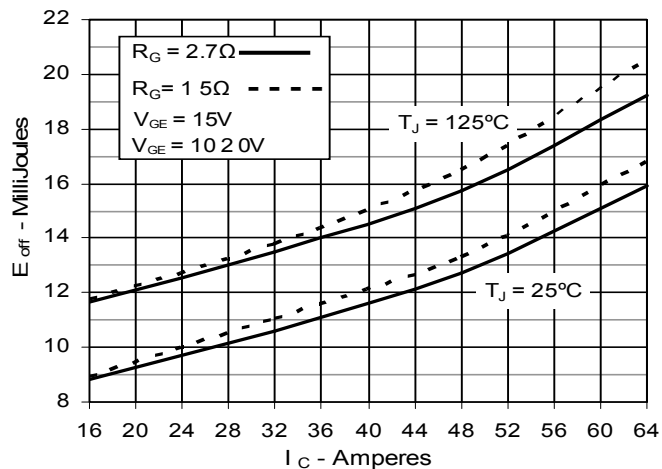

Fig. 12. Dependence of E_{off} on Temperature

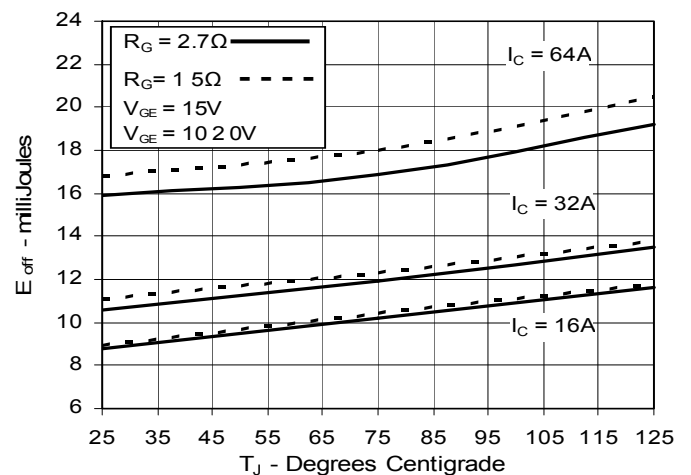

Fig. 13. Maximum Transient Thermal Impedance

