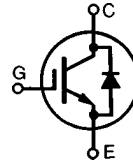

HiPerFAST™ IGBT

with Diode

Combi Pack

 $V_{CES} = 600 \text{ V}$
 $I_{C25} = 60 \text{ A}$
 $V_{CE(sat)} = 2.9 \text{ V}$
 $t_{fi} = 125 \text{ ns}$

Symbol	Test Conditions	Maximum Ratings	
V_{CES}	$T_J = 25^\circ\text{C}$ to 150°C	600	V
V_{CGR}	$T_J = 25^\circ\text{C}$ to 150°C ; $R_{GE} = 1 \text{ M}\Omega$	600	V
V_{GES}	Continuous	± 20	V
V_{GEM}	Transient	± 30	V
I_{C25}	$T_C = 25^\circ\text{C}$	60	A
I_{C90}	$T_C = 90^\circ\text{C}$	32	A
I_{CM}	$T_C = 25^\circ\text{C}$, 1 ms	120	A
SSOA (RBSOA)	$V_{GE} = 15 \text{ V}$, $T_{VJ} = 125^\circ\text{C}$, $R_G = 33 \Omega$ Clamped inductive load, $L = 100 \mu\text{H}$	$I_{CM} = 64$ @ $0.8 V_{CES}$	A
P_C	$T_C = 25^\circ\text{C}$	200	W
T_J		-55 ... +150	$^\circ\text{C}$
T_{JM}		150	$^\circ\text{C}$
T_{stg}		-55 ... +150	$^\circ\text{C}$
Maximum Lead and Tab temperature for soldering 1.6 mm (0.062 in.) from case for 10 s		300	$^\circ\text{C}$
M_d	Mounting torque, TO-247 AD	1.13/10	Nm/lb.in.
Weight	TO-247 SMD	4	g
	TO-247 AD	6	g

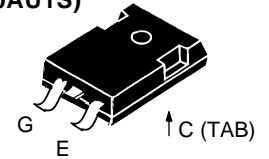
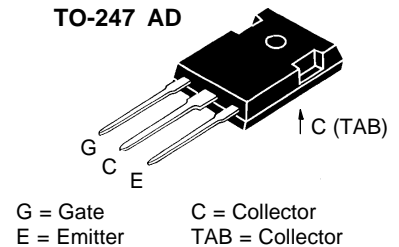
TO-247 SMD
(32N60AU1S)

TO-247 AD

Features

- International standard packages
JEDEC TO-247 SMD surface mountable and JEDEC TO-247 AD
- High frequency IGBT and antiparallel FRED in one package
- High current handling capability
- 2nd generation HDMOS™ process
- MOS Gate turn-on - drive simplicity

Applications

- AC motor speed control
- DC servo and robot drives
- DC choppers
- Uninterruptible power supplies (UPS)
- Switched-mode and resonant-mode power supplies

Advantages

- Space savings (two devices in one package)
- High power density
- Suitable for surface mounting
- Switching speed for high frequency applications
- Easy to mount with 1 screw, TO-247 (isolated mounting screw hole)

Symbol	Test Conditions	Characteristic Values ($T_J = 25^\circ\text{C}$, unless otherwise specified)		
		min.	typ.	max.
BV_{CES}	$I_C = 750 \mu\text{A}$, $V_{GE} = 0 \text{ V}$	600		V
$V_{GE(th)}$	$I_C = 250 \mu\text{A}$, $V_{CE} = V_{GE}$	2.5		5.5 V
I_{CES}	$V_{CE} = 0.8 \cdot V_{CES}$ $V_{GE} = 0 \text{ V}$	$T_J = 25^\circ\text{C}$		500 μA
		$T_J = 125^\circ\text{C}$		8 mA
I_{GES}	$V_{CE} = 0 \text{ V}$, $V_{GE} = \pm 20 \text{ V}$			$\pm 100 \text{ nA}$
$V_{CE(sat)}$	$I_C = I_{C90}$, $V_{GE} = 15 \text{ V}$			2.9 V

Symbol	Test Conditions	Characteristic Values		
		$(T_J = 25^\circ\text{C}, \text{ unless otherwise specified})$		
		min.	typ.	max.
g_{fs}	$I_C = I_{C90}, V_{CE} = 10\text{ V},$ Pulse test, $t \leq 300\ \mu\text{s},$ duty cycle $\leq 2\%$	15	20	S
C_{ies}	$V_{CE} = 25\text{ V}, V_{GE} = 0\text{ V}, f = 1\text{ MHz}$		2500	pF
C_{oes}			270	pF
C_{res}			70	pF
Q_g	$I_C = I_{C90}, V_{GE} = 15\text{ V}, V_{CE} = 0.5 V_{CES}$		125	150 nC
Q_{ge}			23	35 nC
Q_{gc}			50	75 nC
$t_{d(on)}$	Inductive load, $T_J = 25^\circ\text{C}$ $I_C = I_{C90}, V_{GE} = 15\text{ V}, L = 100\ \mu\text{H},$ $V_{CE} = 0.8 V_{CES}, R_G = R_{off} = 4.7\ \Omega$ Remarks: Switching times may increase for V_{CE} (Clamp) $> 0.8 \cdot V_{CES},$ higher T_J or increased R_G		25	ns
t_{ri}			30	ns
$t_{d(off)}$			120	200 ns
t_{fi}			125	175 ns
E_{off}			1.8	mJ
$t_{d(on)}$	Inductive load, $T_J = 125^\circ\text{C}$ $I_C = I_{C90}, V_{GE} = 15\text{ V}, L = 100\ \mu\text{H}$ $V_{CE} = 0.8 V_{CES}, R_G = R_{off} = 4.7\ \Omega$ Remarks: Switching times may increase for V_{CE} (Clamp) $> 0.8 \cdot V_{CES},$ higher T_J or increased R_G		25	ns
t_{ri}			35	ns
E_{on}			1	mJ
$t_{d(off)}$			140	ns
t_{fi}			260	ns
E_{off}		4	mJ	
R_{thJC}				0.62 K/W
R_{thCK}		0.25		K/W

Symbol	Test Conditions	Characteristic Values		
		$(T_J = 25^\circ\text{C}, \text{ unless otherwise specified})$		
		min.	typ.	max.
V_F	$I_F = I_{C90}, V_{GE} = 0\text{ V},$ Pulse test, $t \leq 300\ \mu\text{s},$ duty cycle $d \leq 2\%$			1.6 V
I_{RM}	$I_F = I_{C90}, V_{GE} = 0\text{ V}, -di_F/dt = 240\text{ A}/\mu\text{s}$ $V_R = 360\text{ V}$ $I_F = 1\text{ A}; -di/dt = 100\text{ A}/\mu\text{s}; V_R = 30\text{ V}$		10	15 A
t_{tr}		$T_J = 125^\circ\text{C}$	150	ns
		$T_J = 25^\circ\text{C}$	35	50 ns
R_{thJC}				1 K/W

Min. Recommended Footprint

(Dimensions in inches and mm)

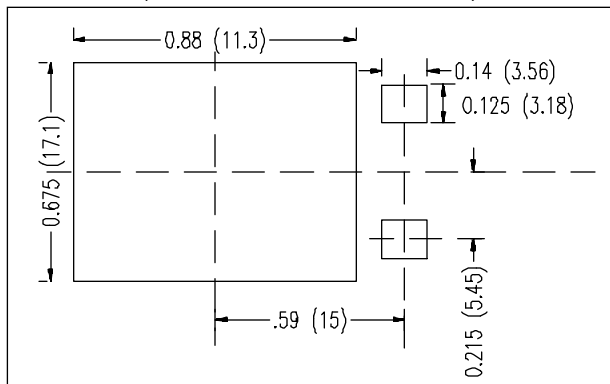

TO-247 AD Outline

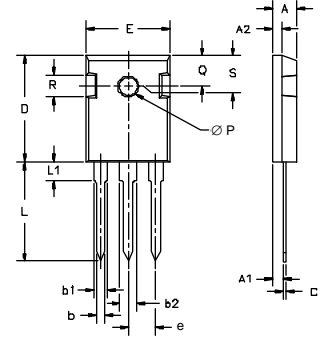

Dim.	Millimeter		Inches	
	Min.	Max.	Min.	Max.
A	4.7	5.3	.185	.209
A ₁	2.2	2.54	.087	.102
A ₂	2.2	2.6	.059	.098
b	1.0	1.4	.040	.055
b ₁	1.65	2.13	.065	.084
b ₂	2.87	3.12	.113	.123
C	.4	.8	.016	.031
D	20.80	21.46	.819	.845
E	15.75	16.26	.610	.640
e	5.20	5.72	0.205	0.225
L	19.81	20.32	.780	.800
L1		4.50		.177
∅P	3.55	3.65	.140	.144
Q	5.89	6.40	0.232	0.252
R	4.32	5.49	.170	.216
S	6.15	BSC	.242	BSC

TO-247 SMD Outline

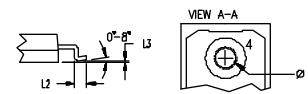
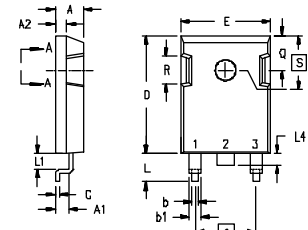

- Gate
- Collector
- Emitter
- Collector

Dim.	Millimeter		Inches	
	Min.	Max.	Min.	Max.
A	4.83	5.21	.190	.205
A ₁	2.29	2.54	.090	.100
A ₂	1.91	2.16	.075	.085
b	1.14	1.40	.045	.055
b ₁	1.91	2.13	.075	.084
C	0.61	0.80	.024	.031
D	20.80	21.34	.819	.840
E	15.75	16.13	.620	.635
e	5.45	BSC	.215	BSC
L	4.90	5.10	.193	.201
L1	2.70	2.90	.106	.114
L2	2.10	2.30	.083	.091
L3	0.00	0.10	.00	.004
L4	1.90	2.10	.075	.083
∅P	3.55	3.65	.140	.144
Q	5.59	6.20	.220	.244
R	4.32	4.83	.170	.190
S	6.15	BSC	.242	BSC

IXYS reserves the right to change limits, test conditions, and dimensions.