

# High Voltage MOSFET

N-Channel, Depletion Mode

**IXTP 02N50D**  
**IXTU 02N50D**  
**IXTY 02N50D**

$V_{DSS} = 500 \text{ V}$   
 $I_{D25} = 200 \text{ mA}$   
 $R_{DS(on)} = 30 \ \Omega$

## Preliminary Data Sheet

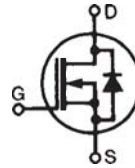

Symbol	Test Conditions	Maximum Ratings		
$V_{DSX}$	$T_J = 25^\circ\text{C}$ to $150^\circ\text{C}$	500	V	
$V_{DGX}$	$T_J = 25^\circ\text{C}$ to $150^\circ\text{C}$	500	V	
$V_{GS}$	Continuous	$\pm 20$	V	
$V_{GSM}$	Transient	$\pm 30$	V	
$I_{DSS}$	$T_C = 25^\circ\text{C}$ ; $T_J = 25^\circ\text{C}$ to $150^\circ\text{C}$	200	mA	
$I_{DM}$	$T_C = 25^\circ\text{C}$ , pulse width limited by $T_J$	800	mA	
$P_D$	$T_C = 25^\circ\text{C}$	25	W	
	$T_A = 25^\circ\text{C}$	1.1	W	
$T_J$		-55 ... +150	$^\circ\text{C}$	
$T_{JM}$		150	$^\circ\text{C}$	
$T_{stg}$		-55 ... +150	$^\circ\text{C}$	
$T_L$	1.6 mm (0.063 in.) from case for 10 s	300	$^\circ\text{C}$	
$T_{ISOL}$	Plastic case for 10 s (IXTU)	300	$^\circ\text{C}$	
$M_d$	Mounting torque	TO-220	1.3 / 10	Nm/lb.
		TO-251	4	g
		TO-252	0.8	g
Weight	TO-220	4	g	
	TO-251	0.8	g	
	TO-252	0.8	g	

TO-220 (IXTP)

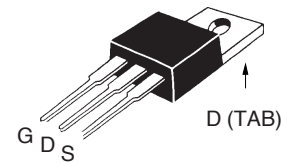

TO-251 (IXTU)

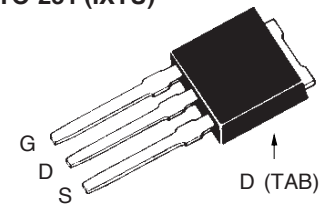

TO-252 (IXTY)

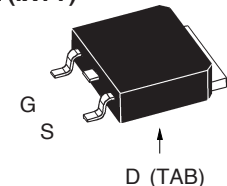

Pins: 1 - Gate    2 - Drain  
 3 - Source    TAB - Drain

Symbol	Test Conditions ( $T_J = 25^\circ\text{C}$ , unless otherwise specified)	Characteristic Values		
		min.	typ.	max.
$V_{DSX}$	$V_{GS} = -10 \text{ V}$ , $I_D = 25 \ \mu\text{A}$	500		V
$V_{GS(off)}$	$V_{DS} = 25 \text{ V}$ , $I_D = 25 \ \mu\text{A}$	-2.5		V
$I_{GSS}$	$V_{GS} = \pm 20 \text{ V}_{DC}$ , $V_{DS} = 0$			$\pm 100 \text{ nA}$
$I_{DSX(off)}$	$V_{DS} = V_{DSS}$ , $V_{GS} = -10 \text{ V}$ $T_J = 125^\circ\text{C}$			10 $\mu\text{A}$ 250 $\mu\text{A}$
$R_{DS(on)}$	$V_{GS} = 0 \text{ V}$ , $I_D = 50 \text{ mA}$ Note 1		20	30 $\Omega$
$I_{D(on)}$	$V_{GS} = 0 \text{ V}$ , $V_{DS} = 25 \text{ V}$ Note 1		250	mA

### Features

- Normally ON mode
- Low  $R_{DS(on)}$  HDMOS™ process
- Rugged polysilicon gate cell structure
- Fast switching speed

### Applications

- Level shifting
- Triggers
- Solid state relays
- Current regulators

Symbol	Test Conditions		Characteristic Values		
			min.	typ.	max.
$g_{fs}$	$V_{DS} = 50\text{ V}; I_D = 200\text{ mA}$	Note1	100	150	mS
$C_{iss}$	$V_{GS} = -10\text{ V}, V_{DS} = 25\text{ V}, f = 1\text{ MHz}$			120	pF
$C_{oss}$			25	pF	
$C_{rss}$			5	pF	
$t_{d(on)}$	$V_{ds} = 100\text{ V}, I_D = 50\text{ mA}$			9	ns
$t_r$	$V_{gs} = 0\text{ V to } -10$		4	ns	
$t_{d(off)}$	$R_G = 30\Omega$ (External)		28	ns	
$t_f$			45	ns	
$R_{thJC}$				5	K/W
$R_{thCS}$	TO-220		0.25		K/W

Symbol	Test Conditions		Characteristic Values			
			min.	typ.	max.	
$V_{SD}$	$V_{GS} = -10\text{ V}, I_F = 200\text{ mA}$	Note1		0.7	1.5	V
$t_{rr}$	$I_F = 0.75\text{ A}, -di/dt = 10\text{ A}/\mu\text{s},$ $V_{DS} = 25\text{ V}, V_{GS} = -10\text{ V}$				1.0	$\mu\text{s}$

Note1: Pulse test,  $t \leq 300\ \mu\text{s}$ , duty cycle  $d \leq 2\%$

### TO-252 AA Outline

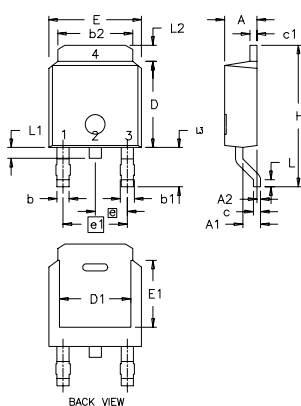

Pins: 1 - Gate 2 - Drain  
3 - Source TAB - Drain

Dim.	Millimeter		Inches	
	Min.	Max.	Min.	Max.
A	2.19	2.38	0.086	0.094
A1	0.89	1.14	0.035	0.045
A2	0	0.13	0	0.005
b	0.64	0.89	0.025	0.035
b1	0.76	1.14	0.030	0.045
b2	5.21	5.46	0.205	0.215
c	0.46	0.58	0.018	0.023
c1	0.46	0.58	0.018	0.023
D	5.97	6.22	0.235	0.245
D1	4.32	5.21	0.170	0.205
E	6.35	6.73	0.250	0.265
E1	4.32	5.21	0.170	0.205
e	2.28 BSC		0.090 BSC	
e1	4.57 BSC		0.180 BSC	
H	9.40	10.42	0.370	0.410
L	0.51	1.02	0.020	0.040
L1	0.64	1.02	0.025	0.040
L2	0.89	1.27	0.035	0.050
L3	2.54	2.92	0.100	0.115

### TO-220 AD Outline

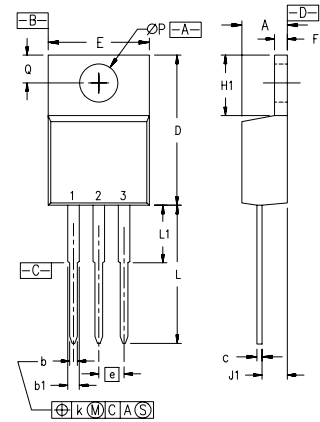

Pins: 1 - Gate 2 - Drain  
3 - Source TAB - Drain

SYM	INCHES		MILLIMETERS	
	MIN	MAX	MIN	MAX
A	.170	.190	4.32	4.83
b	.025	.040	0.64	1.02
b1	.045	.065	1.15	1.65
c	.014	.022	0.35	0.56
D	.580	.630	14.73	16.00
E	.390	.420	9.91	10.66
e	.100 BSC		2.54 BSC	
F	.045	.055	1.14	1.40
H1	.230	.270	5.85	6.85
J1	.090	.110	2.29	2.79
k	0	.015	0	0.38
L	.500	.550	12.70	13.97
L1	.110	.230	2.79	5.84
$\varnothing P$	.139	.161	3.53	4.08
Q	.100	.125	2.54	3.18

### TO-251 AA Outline

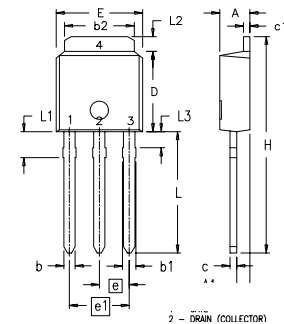

Pins: 1 - Gate 2 - Drain  
3 - Source TAB - Drain

Dim.	Millimeter		Inches	
	Min.	Max.	Min.	Max.
A	2.19	2.38	.086	.094
A1	0.89	1.14	0.035	.045
b	0.64	0.89	.025	.035
b1	0.76	1.14	.030	.045
b2	5.21	5.46	.205	.215
c	0.46	0.58	.018	.023
c1	0.46	0.58	.018	.023
D	5.97	6.22	.235	.245
E	6.35	6.73	.250	.265
e	2.28 BSC		.090 BSC	
e1	4.57 BSC		.180 BSC	
H	17.02	17.78	.670	.700
L	8.89	9.65	.350	.380
L1	1.91	2.28	.075	.090
L2	0.89	1.27	.035	.050
L3	1.15	1.52	.045	.060

IXYS reserves the right to change limits, test conditions, and dimensions.

IXYS MOSFETs and IGBTs are covered by one or more of the following U.S. patents:	4,835,592	4,931,844	5,049,961	5,237,481	6,162,665	6,404,065 B1	6,683,344	6,727,585
	4,850,072	5,017,508	5,063,307	5,381,025	6,259,123 B1	6,534,343	6,710,405 B2	6,759,692
	4,881,106	5,034,796	5,187,117	5,486,715	6,306,728 B1	6,583,505	6,710,463	