

N-Channel JFETs

J108	SST108
J109	SST109
J110	SST110

PRODUCT SUMMARY				
Part Number	V _{GS(off)} (V)	r _{DS(on)} Max (Ω)	I _{D(off)} Typ (pA)	t _{ON} Typ (ns)
J/SST108	-3 to -10	8	20	4
J/SST109	-2 to -6	12	20	4
J/SST110	-0.5 to -4	18	20	4

FEATURES

- Low On-Resistance: J108 <8 Ω
- Fast Switching—t_{ON}: 4 ns
- Low Leakage: 20 pA
- Low Capacitance: 11 pF
- Low Insertion Loss

BENEFITS

- Low Error Voltage
- High-Speed Analog Circuit Performance
- Negligible “Off-Error” Excellent Accuracy
- Good Frequency Response
- Eliminates Additional Buffering

APPLICATIONS

- Analog Switches
- Choppers
- Sample-and-Hold
- Normally “On” Switches
- Current Limiters

DESCRIPTION

The J/SST108 series is designed with high-performance analog switching applications in mind. It features low on-resistance, good off-isolation, and fast switching.

The SST108 series is comprised of surface-mount devices featuring the lowest r_{DS(on)} of any TO-236 (SOT-23) JFET device.

The TO-226AA (TO-92) plastic package provides a low-cost option. Both the J and SST series are available in tape-and-reel for automated assembly (see Packaging Information). For similar products packaged in TO-206AC (TO-52), see the 2N5432/5433/5434 data sheet.

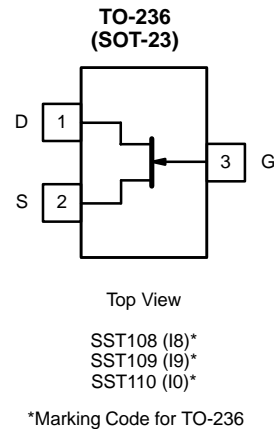
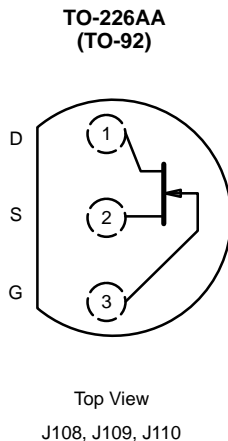



ABSOLUTE MAXIMUM RATINGS

Gate-Drain, Gate-Source Voltage -25 V
 Gate Current 50 mA
 Lead Temperature ($1/16''$ from case for 10 sec.) 300°C
 Storage Temperature -55 to 150°C

Operating Junction Temperature -55 to 150°C
 Power Dissipation^a 350 mW

Notes

a. Derate 2.8 mW/°C above 25°C

SPECIFICATIONS ($T_A = 25^\circ\text{C}$ UNLESS OTHERWISE NOTED)										
Parameter	Symbol	Test Conditions	Typ ^a	Limits						Unit
				J/SST108		J/SST109		J/SST110		
				Min	Max	Min	Max	Min	Max	
Static										
Gate-Source Breakdown Voltage	$V_{(BR)GSS}$	$I_G = -1 \mu\text{A}, V_{DS} = 0 \text{ V}$	-32	-25		-25		-25		V
Gate-Source Cutoff Voltage	$V_{GS(off)}$	$V_{DS} = 5 \text{ V}, I_D = 1 \mu\text{A}$		-3	-10	-2	-6	-0.5	-4	
Saturation Drain Current ^b	I_{DSS}	$V_{DS} = 15 \text{ V}, V_{GS} = 0 \text{ V}$		80		40		10		mA
Gate Reverse Current	I_{GSS}	$V_{GS} = -15 \text{ V}, V_{DS} = 0 \text{ V}$	-0.01		-3		-3		-3	nA
		$T_A = 125^\circ\text{C}$	-5							
Gate Operating Current	I_G	$V_{DG} = 10 \text{ V}, I_D = 10 \text{ mA}$	-0.01							
Drain Cutoff Current	$I_{D(off)}$	$V_{DS} = 5 \text{ V}, V_{GS} = -10 \text{ V}$	0.02		3		3		3	Ω
		$T_A = 125^\circ\text{C}$	1.0							
Drain-Source On-Resistance	$r_{DS(on)}$	$V_{GS} = 0 \text{ V}, V_{DS} \leq 0.1 \text{ V}$			8		12		18	
Gate-Source Forward Voltage	$V_{GS(F)}$	$I_G = 1 \text{ mA}, V_{DS} = 0 \text{ V}$	0.7							V
Dynamic										
Common-Source Forward Transconductance	g_{fs}	$V_{DS} = 5 \text{ V}, I_D = 10 \text{ mA}, f = 1 \text{ kHz}$	17							mS
Common-Source Output Conductance	g_{os}		0.6							
Drain-Source On-Resistance	$r_{ds(on)}$	$V_{GS} = 0 \text{ V}, I_D = 0 \text{ mA}, f = 1 \text{ kHz}$			8		12		18	Ω
Common-Source Input Capacitance	C_{iss}	$V_{DS} = 0 \text{ V}$ $V_{GS} = 0 \text{ V}$ $f = 1 \text{ MHz}$	SST	60						pF
			J Series	60		85		85	85	
Common-Source Reverse Transfer Capacitance	C_{rss}	$V_{DS} = 0 \text{ V}$ $V_{GS} = -10 \text{ V}$ $f = 1 \text{ MHz}$	SST	11						
			J Series	11		15		15	15	
Equivalent Input Noise Voltage	\bar{e}_n	$V_{DG} = 5 \text{ V}, I_D = 10 \text{ mA}$ $f = 1 \text{ kHz}$	3.5							nV/ √Hz
Switching										
Turn-On Time	$t_{d(on)}$	$V_{DD} = 1.5 \text{ V}, V_{GS(H)} = 0 \text{ V}$ See Switching Diagram	3							ns
	t_r		1							
Turn-Off Time	$t_{d(off)}$		4							
	t_f		18							

Notes

a. Typical values are for DESIGN AID ONLY, not guaranteed nor subject to production testing.

b. Pulse test: $PW \leq 300 \mu\text{s}$ duty cycle $\leq 3\%$.

NIP



TYPICAL CHARACTERISTICS (T_A = 25°C UNLESS OTHERWISE NOTED)

On-Resistance and Drain Current vs. Gate-Source Cutoff Voltage

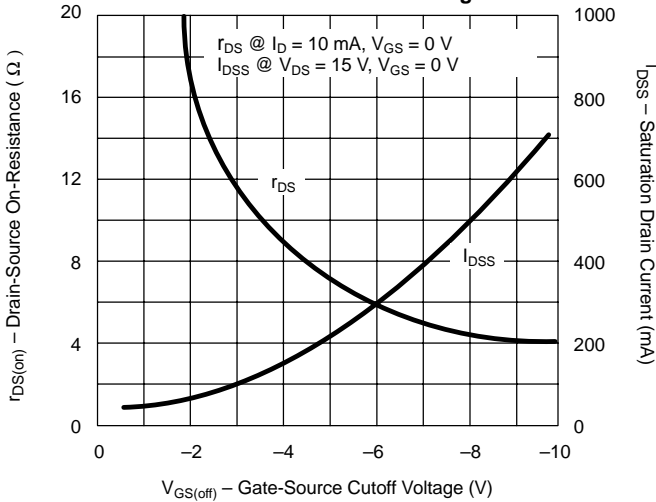

On-Resistance vs. Drain Current

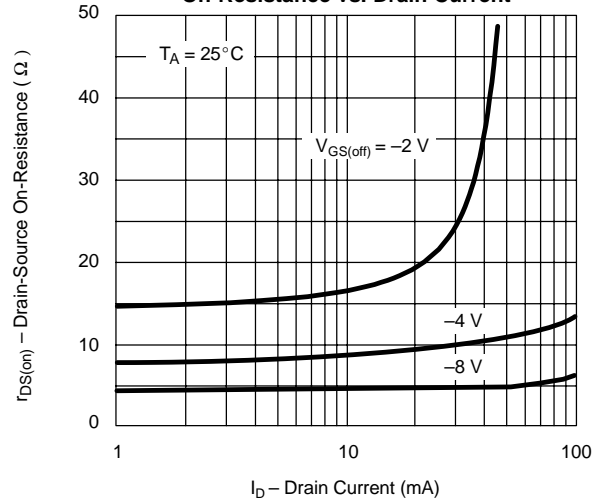

On-Resistance vs. Temperature

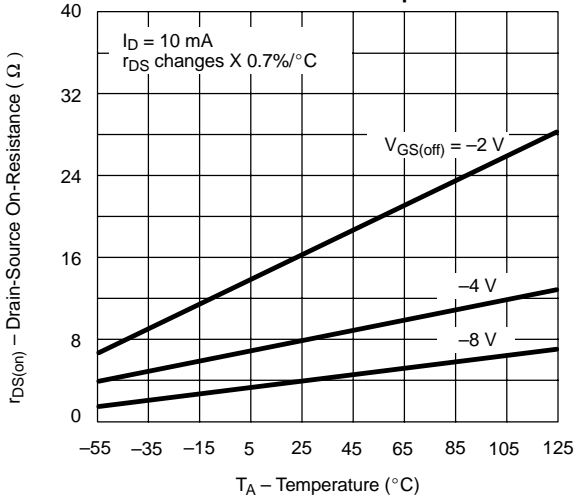

Output Characteristics

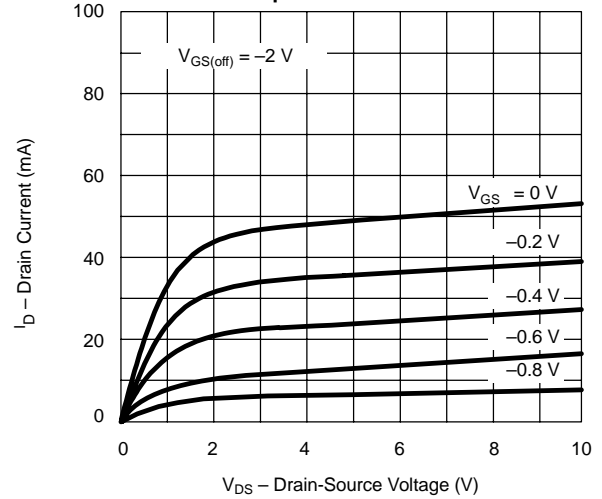

Turn-On Switching

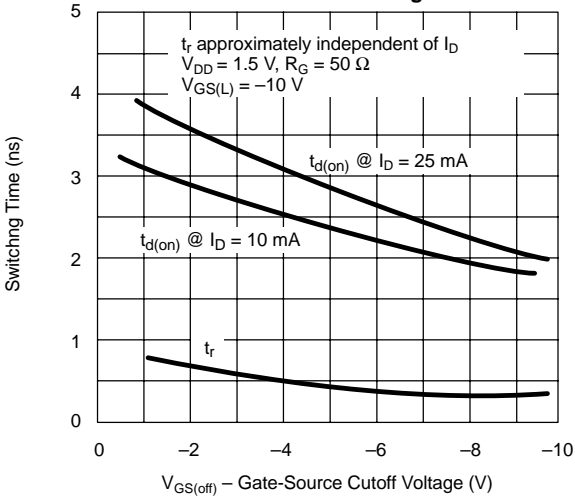

Turn-Off Switching

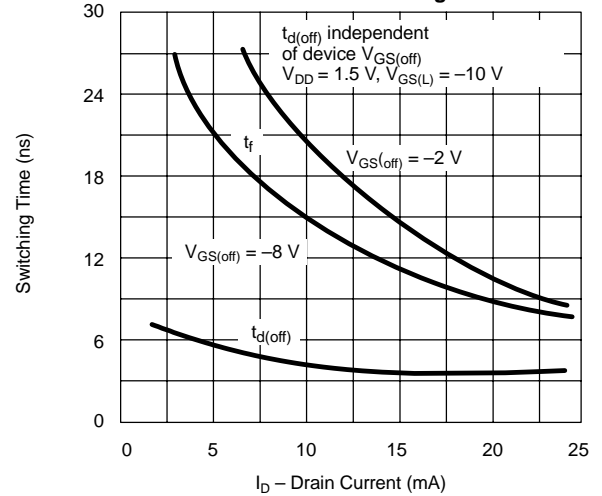



TYPICAL CHARACTERISTICS ($T_A = 25^\circ\text{C}$ UNLESS OTHERWISE NOTED)

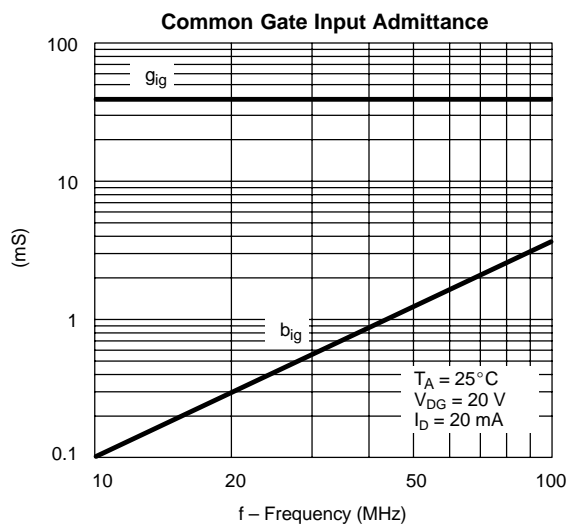
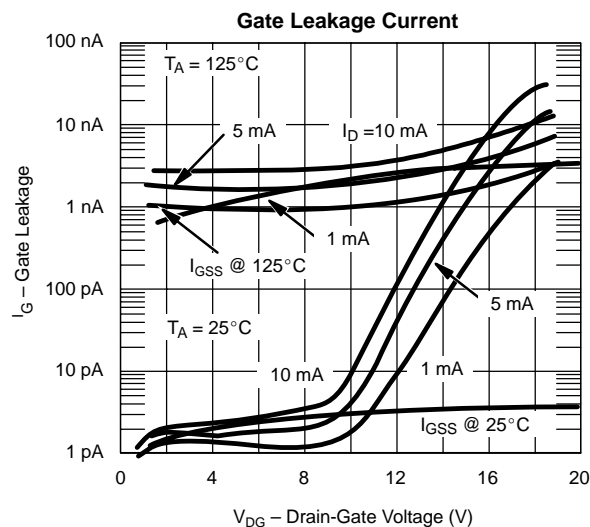
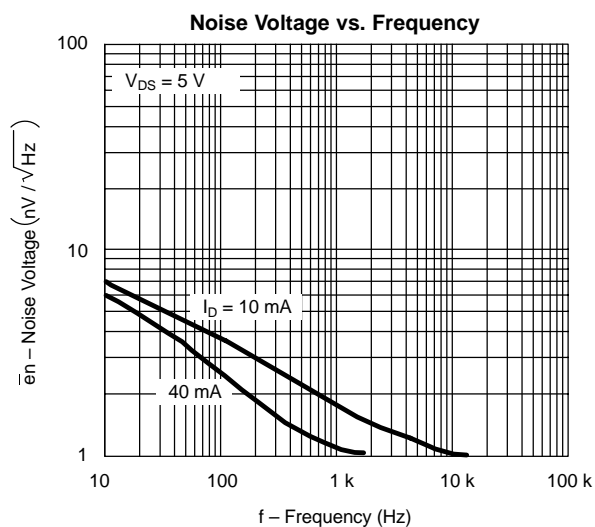
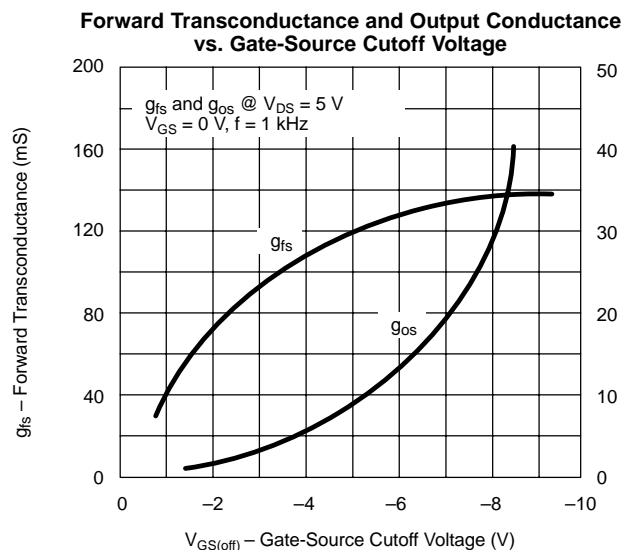
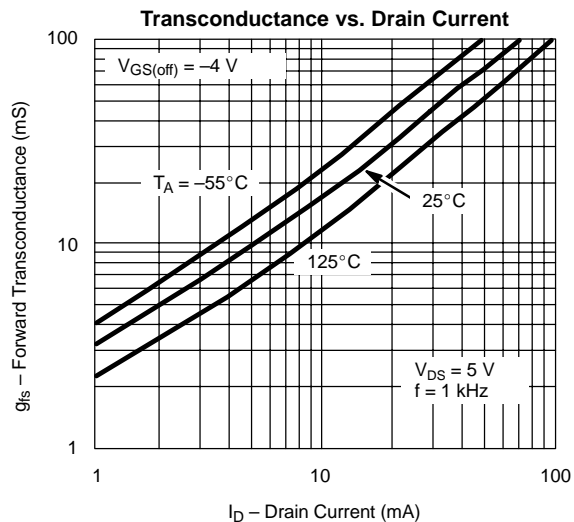
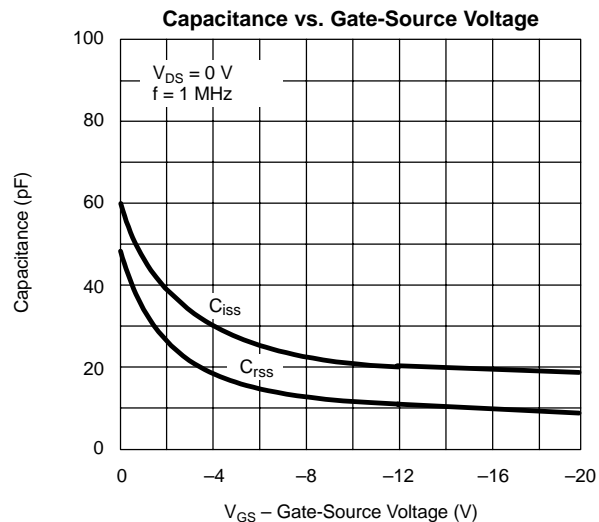



TYPICAL CHARACTERISTICS (T_A = 25°C UNLESS OTHERWISE NOTED)

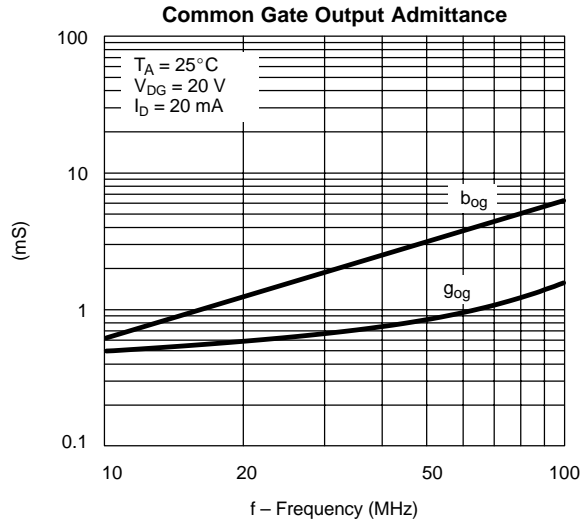
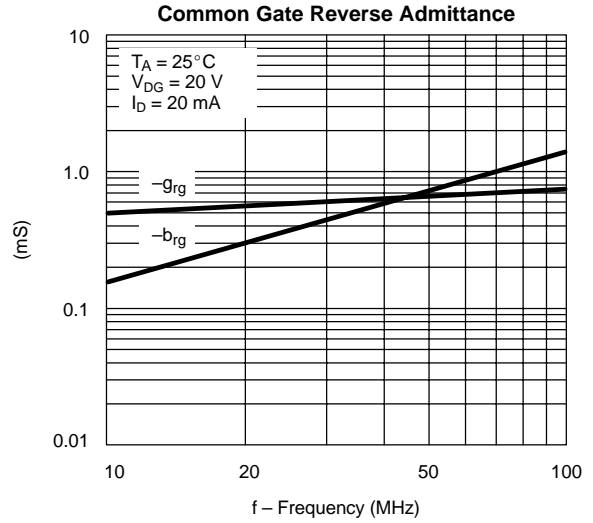
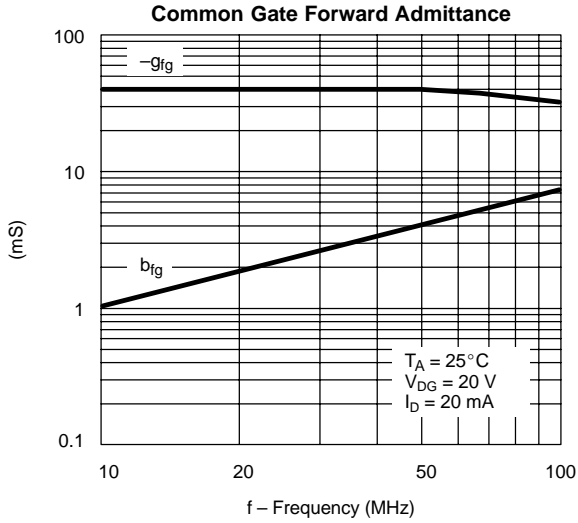

SWITCHING TIME TEST CIRCUIT			
	J/SST108	J/SST109	J/SST110
V _{GS(L)}	-12 V	-7 V	-5 V
R _L *	150 Ω	150 Ω	150 Ω
I _{D(on)}	10 mA	10 mA	10 mA

*Non-inductive

INPUT PULSE

Rise Time < 1 ns
Fall Time < 1 ns
Pulse Width 100 ns
PRF 1 MHz

SAMPLING SCOPE

Rise Time 0.4 ns
Input Resistance 10 MΩ
Input Capacitance 1.5 pF

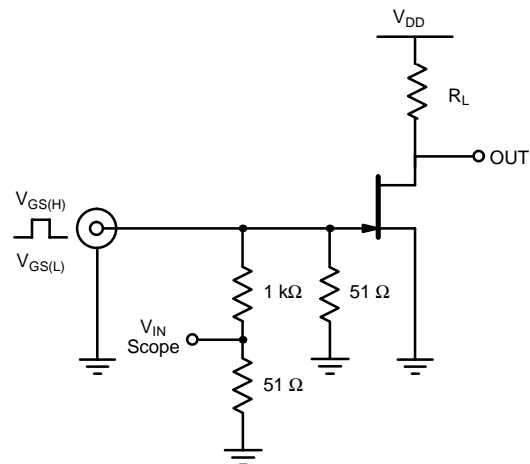



Notice

Specifications of the products displayed herein are subject to change without notice. Vishay Intertechnology, Inc., or anyone on its behalf, assumes no responsibility or liability for any errors or inaccuracies.

Information contained herein is intended to provide a product description only. No license, express or implied, by estoppel or otherwise, to any intellectual property rights is granted by this document. Except as provided in Vishay's terms and conditions of sale for such products, Vishay assumes no liability whatsoever, and disclaims any express or implied warranty, relating to sale and/or use of Vishay products including liability or warranties relating to fitness for a particular purpose, merchantability, or infringement of any patent, copyright, or other intellectual property right.

The products shown herein are not designed for use in medical, life-saving, or life-sustaining applications. Customers using or selling these products for use in such applications do so at their own risk and agree to fully indemnify Vishay for any damages resulting from such improper use or sale.