



MOS FIELD EFFECT TRANSISTOR

2SJ135

FAST SWITCHING P-CHANNEL SILICON POWER MOS FET

PACKAGE DIMENSIONS
(Unit: mm)

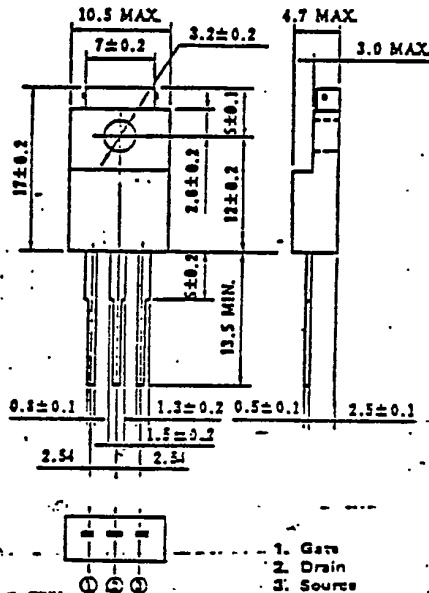

Features

- Suitable for switching power supplies, actuator controls and pulse circuits
 - 4V Gate Drive — Logic Level —
 - Large current switching : $I_D(DC) = 5A$
 - Low $R_{DS(on)}$
 - No Secondary Breakdown
- Absolute Maximum Ratings ($T_a = 25^\circ C$)
- | | | |
|--------------------------|--------------|----------------|
| Drain to Source Voltage | V_{DS} | -100V |
| Gate to Source Voltage | V_{GS} | ± 20V |
| Continuous Drain Current | $I_D(DC)$ | ± 5.0A |
| Pulse Drain Current | $I_D(pulse)$ | * ± 20A |
| Total Power Dissipation | PT | 2.0W |
| Total Power Dissipation | PT** | 30W |
| Channel Temperature | T_{ch} | 150 °C |
| Storage Temperature | T_{stg} | -55 to +150 °C |
- * $T_{ch} \leq 150^\circ C$
** $T_c = 25^\circ C$

Electrical Characteristics ($T_a = 25^\circ C$)

Characteristics	Symbol	Min.	Typ.	Max.	Unit	Test Conditions
Drain Leakage Current	I_{DSS}			- 10	μA	$V_{DS} = -100V, V_{GS} = 0$
Gate to Source Leakage Current	I_{GSS}			100	nA	$V_{GS} = 20V, V_{DS} = 0$
Gate to Source Cutoff Voltage	$V_{GS(off)}$	-1.0		-3.0	V	$V_{DS} = -10V, I_D = -1.0A$
Forward Transfer Admittance	$ y_{fs} $	1.0			S	$V_{DS} = -10V, I_D = -3.5A$
Drain to Source On-State Resistance	$R_{DS(on)}$			0.6	Ω	$V_{GS} = -10V, I_D = -3.5A$
Drain to Source On-State Resistance	$R_{DS(on)}$			0.9	Ω	$V_{GS} = -4.0V, I_D = -3.5A$
Input Capacitance	C_{iss}		1600		pF	$V_{DS} = -10V, V_{GS} = 0$
Output Capacitance	C_{oss}		400		pF	$V_{GS} = 0, f = 1.0MHz$
Reverse Transfer Capacitance	C_{rss}		65		pF	$f = 1.0MHz$
Turn-On Delay Time	$t_{d(on)}$		9		ns	$I_D = -3.5A, V_{GS(on)} = -10V$
Rise Time	t_r		35		ns	$V_{cc} = -50V, R_L = 15 \Omega$
Turn-Off Delay Time	$t_{d(off)}$		55		ns	
Fall Time	t_f		40		ns	

NEC cannot assume any responsibility for any circuits shown or represent that they are free from patent infringement.

TURN-ON AND TURN-OFF TIME TEST CIRCUIT

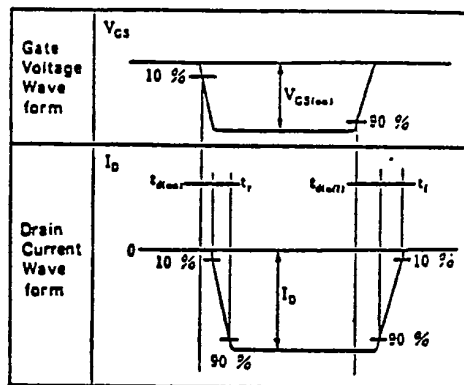
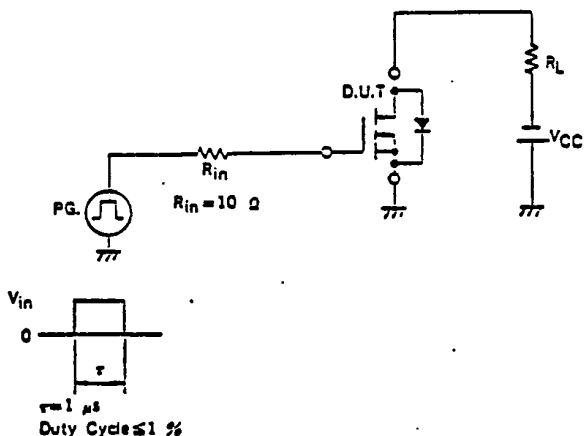

DERATING FACTOR OF FORWARD BIAS SAFE OPERATING AREA

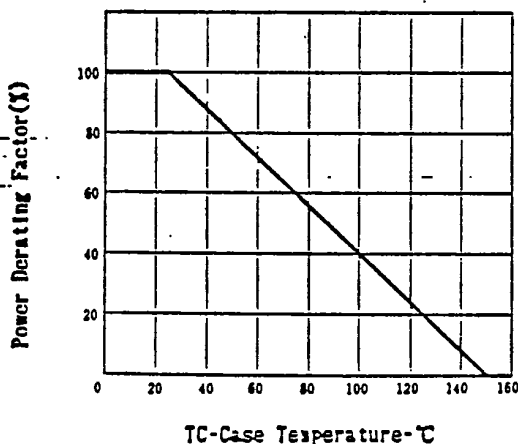

FORWARD BIAS SAFE OPERATING AREA

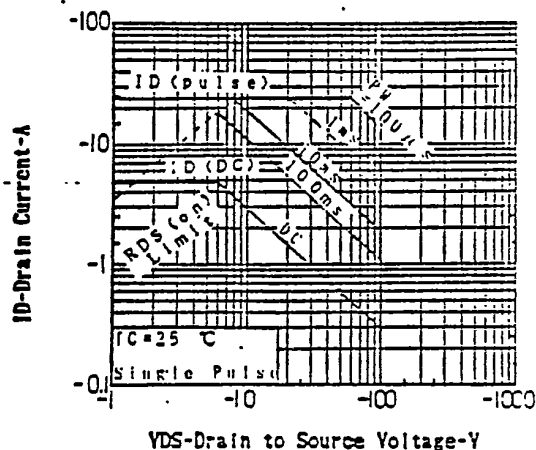

TOTAL POWER DISSIPATION vs. CASE TEMPERATURE

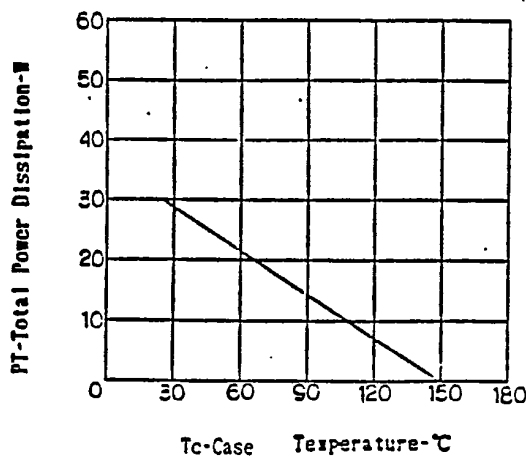

DRAIN CURRENT vs. DRAIN TO SOURCE VOLTAGE

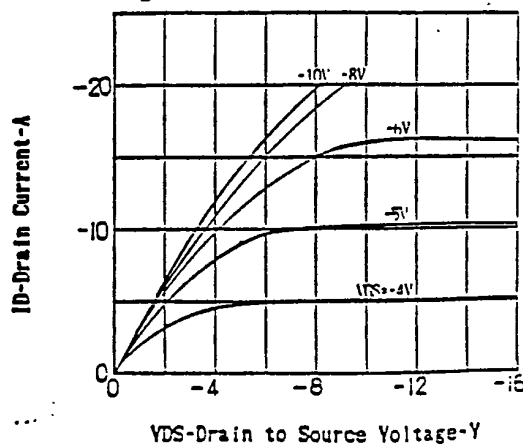

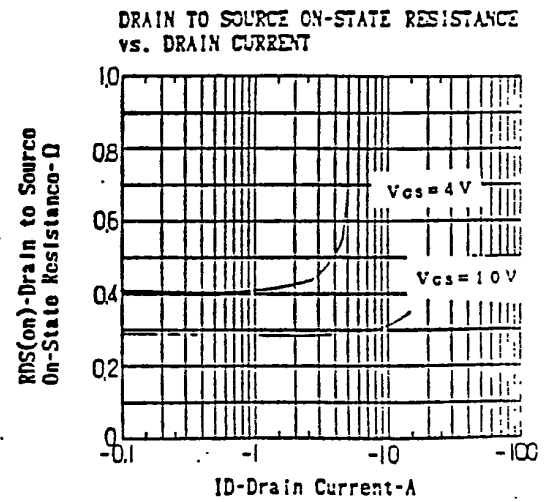
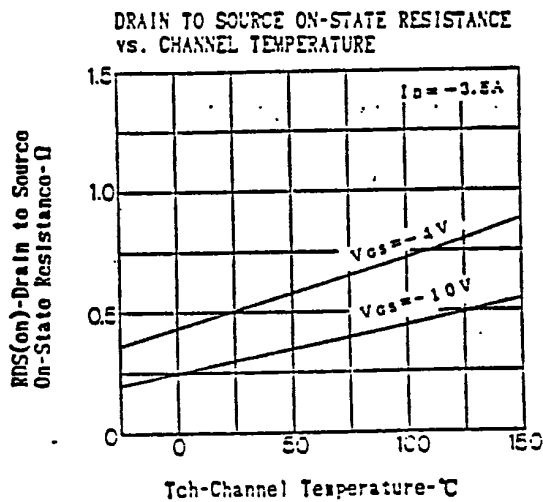
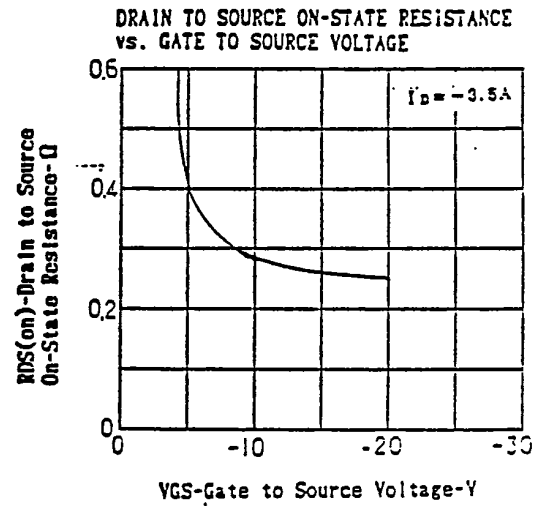
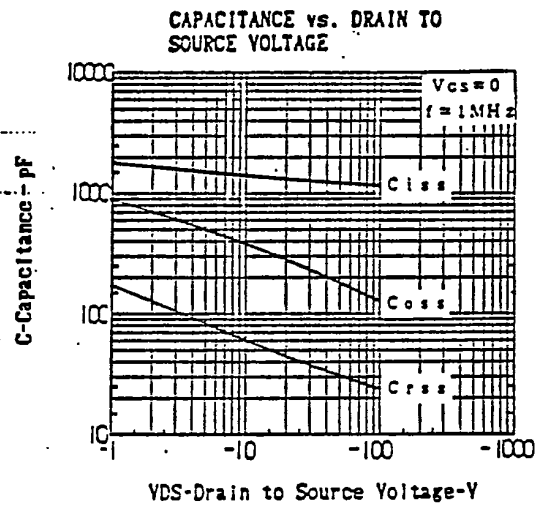
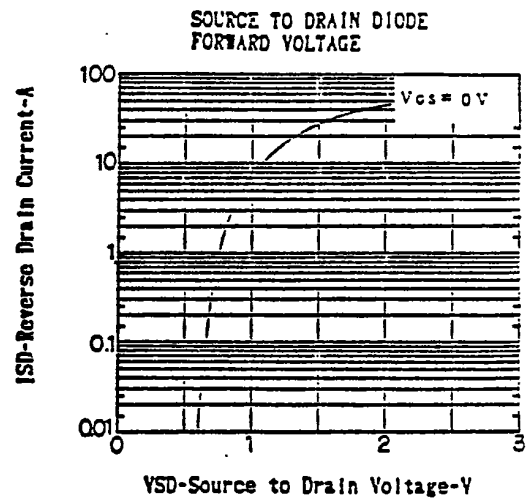
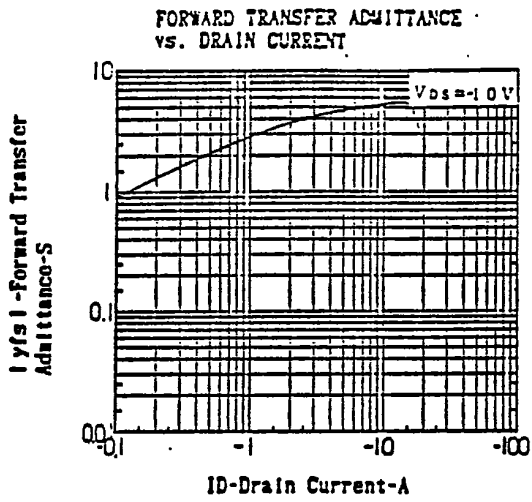

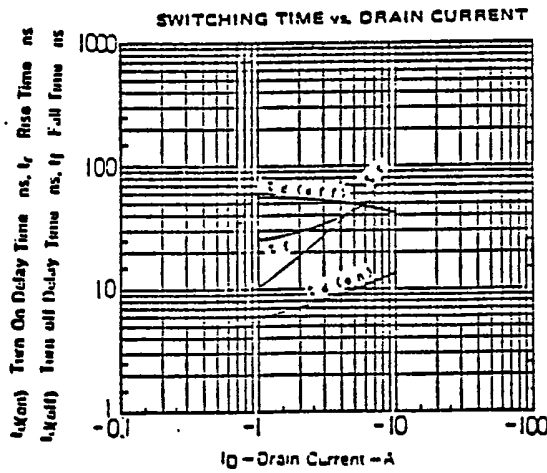
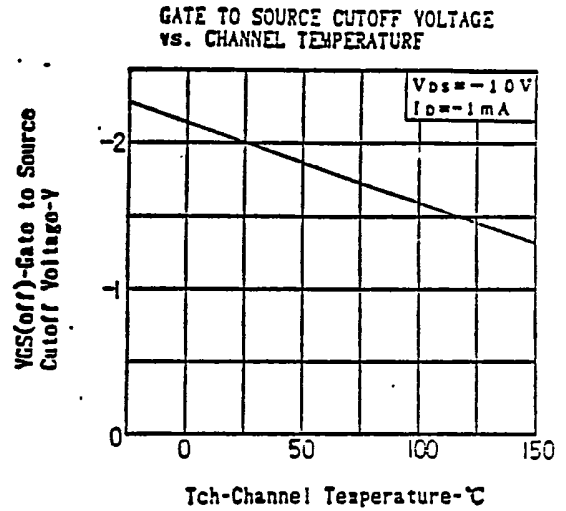
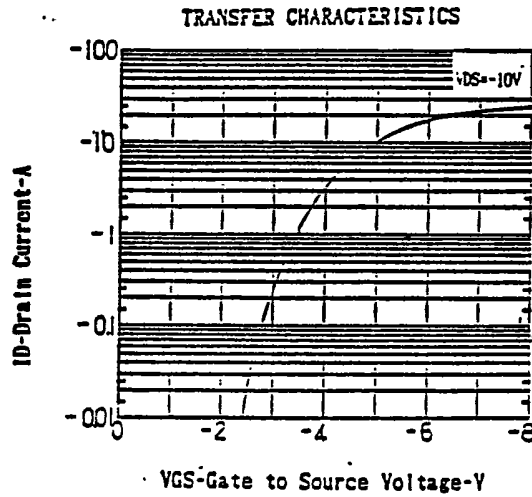

NEC Corporation

INTERNATIONAL ELECTRON DEVICES DIV.
 NEC Building, 33-1, Shiba Gocho
 Minato-ku, Tokyo 108, Japan
 Tel: Tokyo 454-1111
 Telex Address: NECTOK J22626
 Cable Address: MICROPHONE TOKYO