

# J211 / MMBFJ211 N-Channel RF Amplifier

## Description

This device is designed for HF/VHF mixer/amplifier and applications where process 50 is not adequate. Sufficient gain and low-noise for sensitive receivers. Sourced from process 90.



Figure 1. J211 Device Package

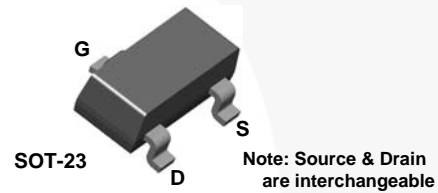

Figure 2. MMBFJ211 Device Package

## Ordering Information

Part Number	Top Mark	Package	Packing Method
J211_D74Z	J211	TO-92 3L	Ammo
MMBFJ211	62W	SOT-23 3L	Tape and Reel

## Absolute Maximum Ratings<sup>(1), (2)</sup>

Stresses exceeding the absolute maximum ratings may damage the device. The device may not function or be operable above the recommended operating conditions and stressing the parts to these levels is not recommended. In addition, extended exposure to stresses above the recommended operating conditions may affect device reliability. The absolute maximum ratings are stress ratings only. Values are at  $T_A = 25^\circ\text{C}$  unless otherwise noted.

Symbol	Parameter	Value	Unit
$V_{DG}$	Drain-Gate Voltage	25	V
$V_{GS}$	Gate-Source Voltage	-25	V
$I_{GF}$	Forward Gate Current	10	mA
$T_J, T_{STG}$	Operating and Storage Junction Temperature Range	-55 to 150	$^\circ\text{C}$

### Notes:

1. These ratings are based on a maximum junction temperature of  $150^\circ\text{C}$ .
2. These are steady-state limits. Fairchild Semiconductor should be consulted on applications involving pulsed or low-duty-cycle operations.

## Thermal Characteristics

Values are at  $T_A = 25^\circ\text{C}$  unless otherwise noted.

Symbol	Parameter	Max.		Unit
		J211 <sup>(3)</sup>	MMBFJ211 <sup>(3)</sup>	
$P_D$	Total Device Dissipation	350	225	mW
	Derate Above $25^\circ\text{C}$	2.8	1.8	mW/ $^\circ\text{C}$
$R_{\theta JC}$	Thermal Resistance, Junction-to-Case	125		$^\circ\text{C}/\text{W}$
$R_{\theta JA}$	Thermal Resistance, Junction-to-Ambient	357	556	$^\circ\text{C}/\text{W}$

### Note:

3. Device mounted on FR-4 PCB 36mm x 18mm x 1.5mm; mounting pad for the collector lead minimum  $6\text{cm}^2$ .

## Electrical Characteristics

Values are at  $T_A = 25^\circ\text{C}$  unless otherwise noted.

Symbol	Parameter	Conditions	Min.	Max.	Unit
<b>Off Characteristics</b>					
$V_{(BR)GSS}$	Gate-Source Breakdown Voltage	$I_G = 1.0 \mu\text{A}, V_{DS} = 0$	-25		V
$I_{GSS}$	Gate Reverse Current	$V_{GS} = 15 \text{ V}, V_{DS} = 0$		-100	pA
$V_{GS(off)}$	Gate-Source Cut-Off Voltage	$V_{DS} = 15 \text{ V}, I_D = 1.0 \text{ nA}$	-2.5	-4.5	V
<b>On Characteristics</b>					
$I_{DSS}$	Zero-Gate Voltage Drain Current <sup>(4)</sup>	$V_{DS} = 15 \text{ V}, V_{GS} = 0$	7.0	20	mA
<b>Small Signal Characteristics</b>					
$g_{fs}$	Common Source Forward Transconductance	$V_{DS} = 15 \text{ V}, V_{GS} = 0,$ $f = 1.0 \text{ kHz}$	7000	12000	$\mu\text{mhos}$
$g_{oss}$	Common Source Output Conductance	$V_{DS} = 15 \text{ V}, V_{GS} = 0,$ $f = 1.0 \text{ kHz}$		200	$\mu\text{mhos}$

### Note:

4. Pulse test: pulse width  $\leq 300 \mu\text{s}$

Typical Performance Characteristics

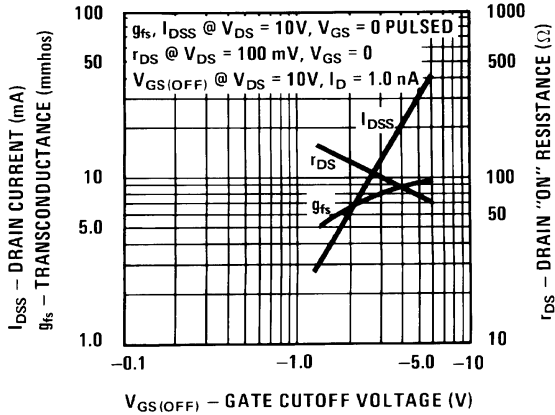

Figure 3. Parameter Interactions

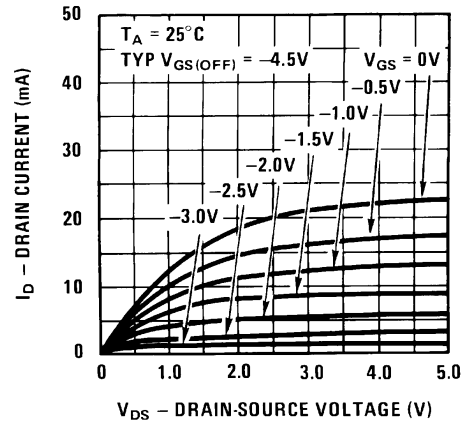

Figure 4. Common Drain-Source

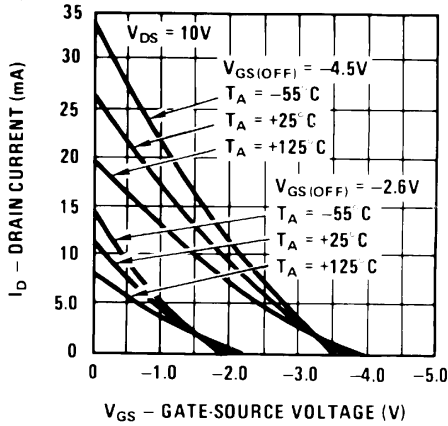

Figure 5. Transfer Characteristics

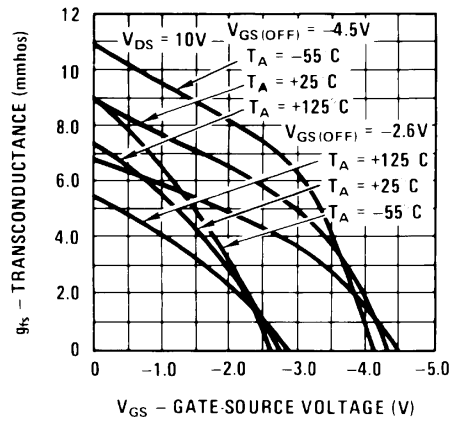

Figure 6. Transfer Characteristics

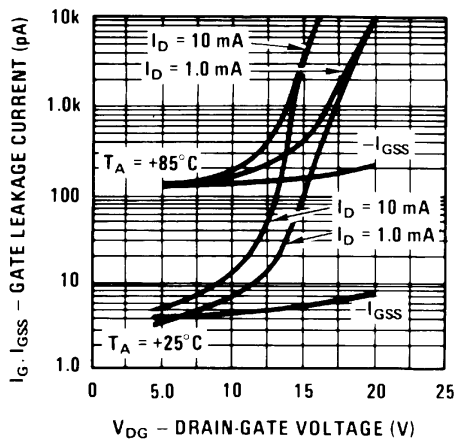

Figure 7. Leakage Current vs. Voltage

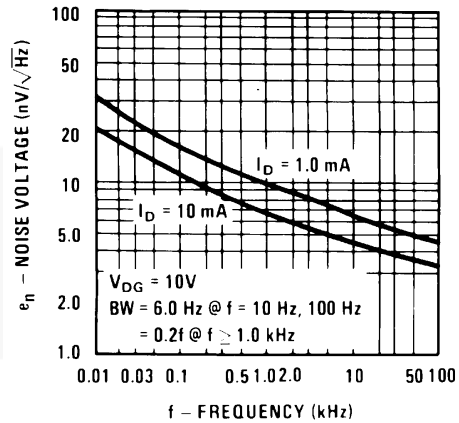

Figure 8. Noise Voltage vs. Frequency

Typical Performance Characteristics (Continued)

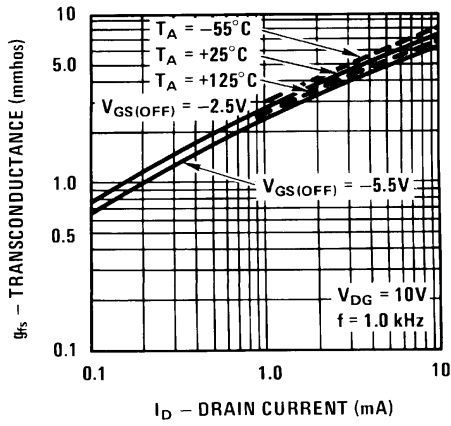

Figure 9. Transconductance vs. Drain Current

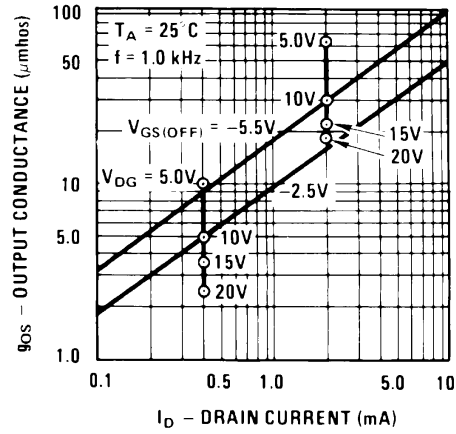

Figure 10. Output Conductance vs. Drain Current

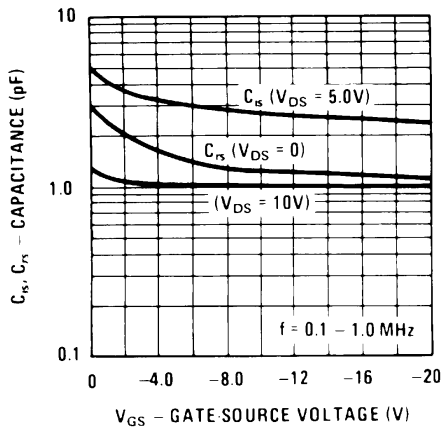

Figure 11. Capacitance vs. Voltage

Common Source Characteristics

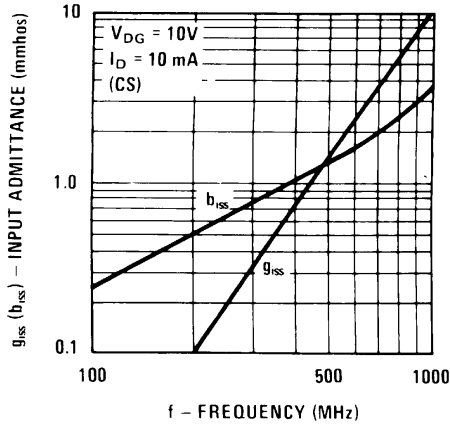

Figure 12. Input Admittance

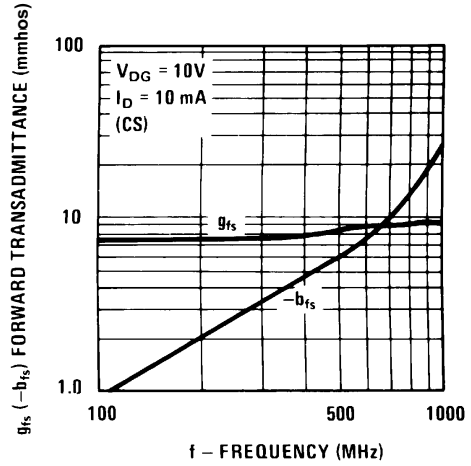

Figure 13. Forward Transadmittance

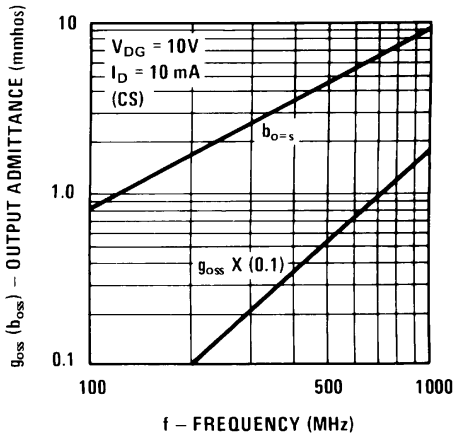

Figure 14. Output Admittance

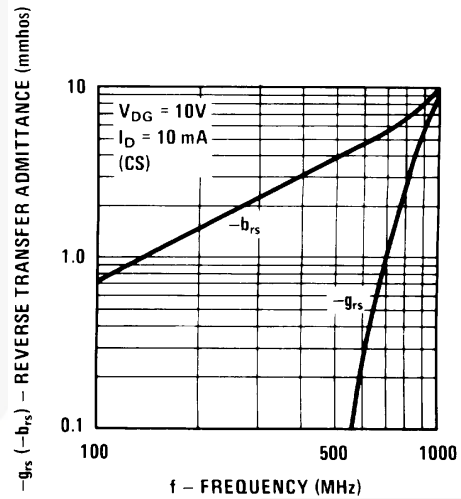

Figure 15. Reverse Transadmittance

Common Gate Characteristics

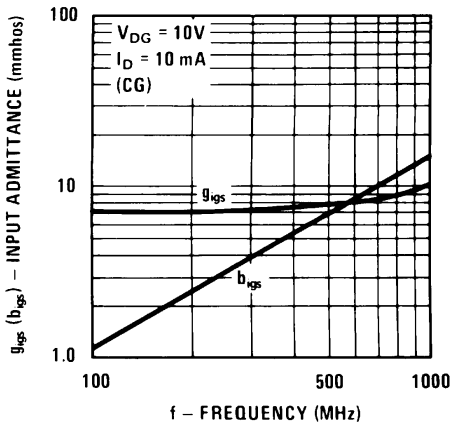

Figure 16. Input Admittance

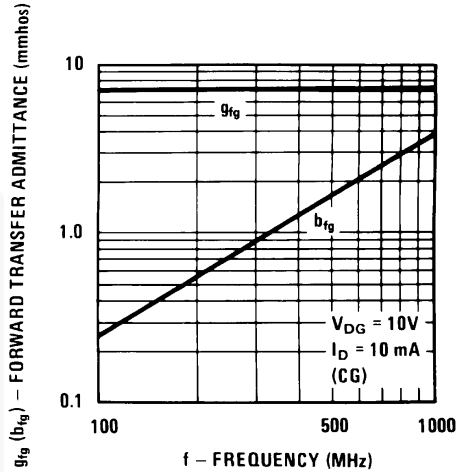

Figure 17. Forward Transadmittance

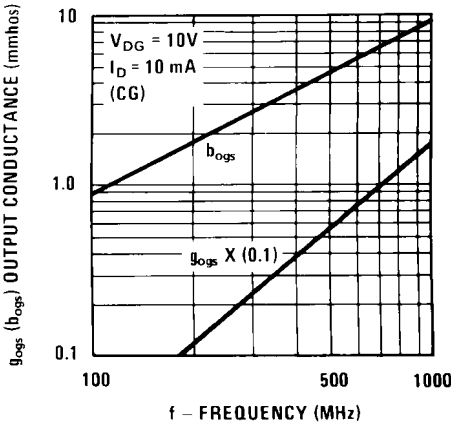

Figure 18. Output Admittance

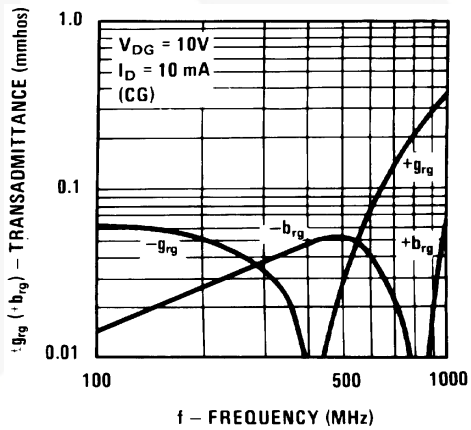
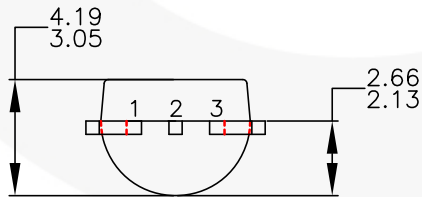
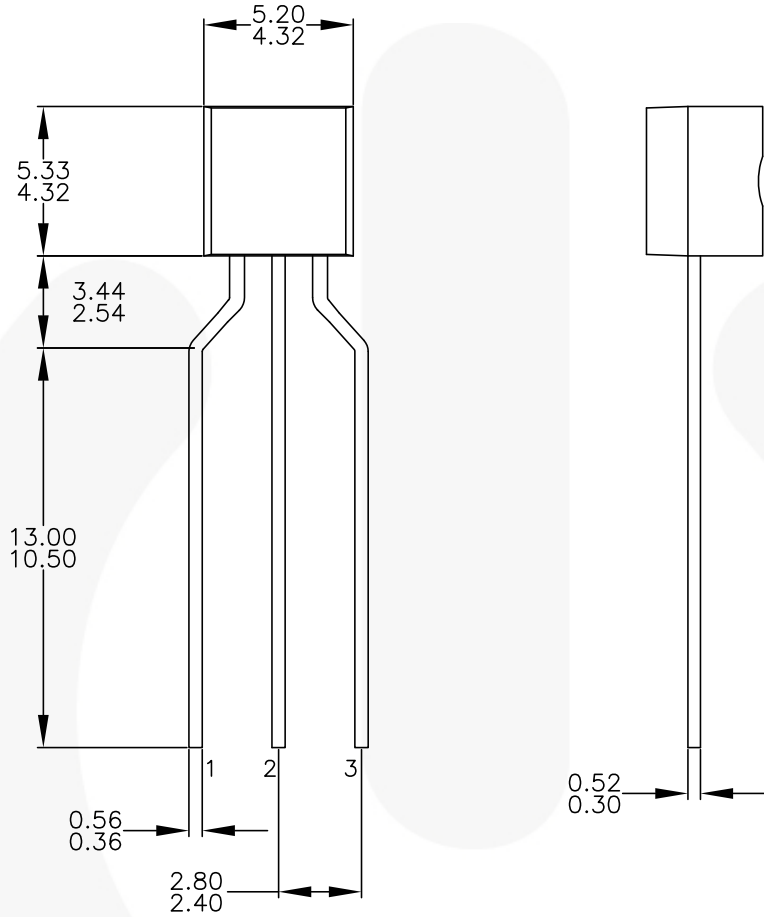

Figure 19. Reverse Transadmittance

Physical Dimensions



NOTES: UNLESS OTHERWISE SPECIFIED

- A. DRAWING CONFORMS TO JEDEC MS-013, VARIATION AC.
- B. ALL DIMENSIONS ARE IN MILLIMETERS.
- C. DRAWING CONFORMS TO ASME Y14.5M-2009.
- D. DRAWING FILENAME: MKT-ZA03FREV3.
- E. FAIRCHILD SEMICONDUCTOR.

Figure 20. 3-Lead, TO-92, Molded, 0.2 In Line Spacing Lead Form

Physical Dimensions (Continued)

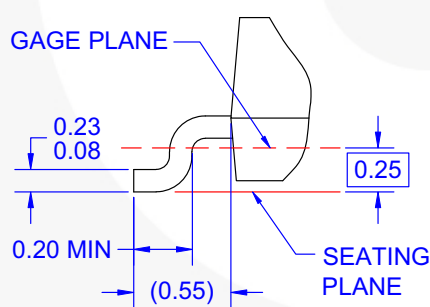
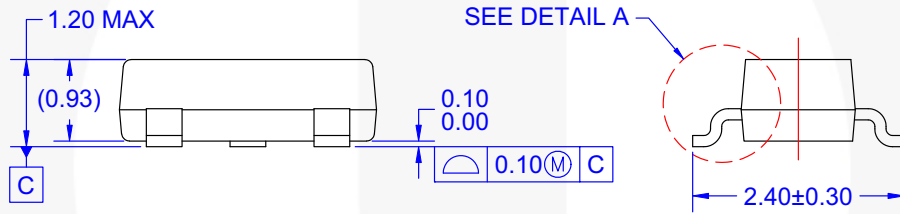
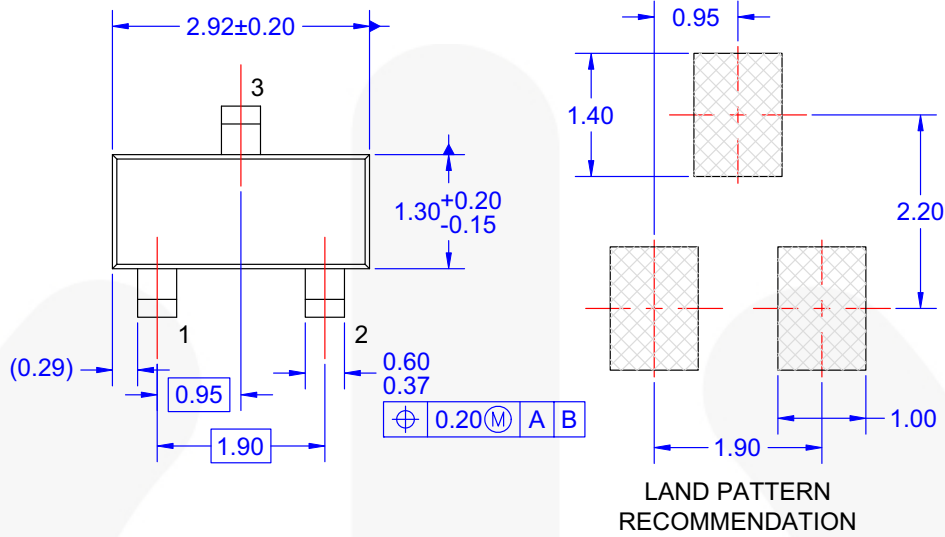

NOTES: UNLESS OTHERWISE SPECIFIED

- A) REFERENCE JEDEC REGISTRATION TO-236, VARIATION AB, ISSUE H.
- B) ALL DIMENSIONS ARE IN MILLIMETERS.
- C) DIMENSIONS ARE INCLUSIVE OF BURRS, MOLD FLASH AND TIE BAR EXTRUSIONS.
- D) DIMENSIONING AND TOLERANCING PER ASME Y14.5M - 1994.
- E) DRAWING FILE NAME: MA03DREV10

**DETAIL A**  
SCALE: 2X





**Figure 21. 3-LEAD, SOT23, JEDEC TO-236, LOW PROFILE**





## TRADEMARKS

The following includes registered and unregistered trademarks and service marks, owned by Fairchild Semiconductor and/or its global subsidiaries, and is not intended to be an exhaustive list of all such trademarks.

AccuPower™	F-PFS™	OPTOPLANAR®	 SYSTEM GENERAL®
AttitudeEngine™	FRFET®	 ®	TinyBoost®
Awinda®	Global Power Resource™ <sup>SM</sup>	Power Supply WebDesigner™	TinyBuck®
AX-CAP®*	GreenBridge™	PowerTrench®	TinyCalc™
BitSiC™	Green FPS™	PowerXS™	TinyLogic®
Build it Now™	Green FPS™ e-Series™	Programmable Active Droop™	TINYOPTO™
CorePLUS™	Gmax™	QFET®	TinyPower™
CorePOWER™	GTO™	QS™	TinyPWM™
CROSSVOLT™	IntelliMAX™	Quiet Series™	TinyWire™
CTL™	ISOPLANAR™	RapidConfigure™	TranSiC™
Current Transfer Logic™	Making Small Speakers Sound Louder and Better™	 ™	TriFault Detect™
DEUXPEED®	MegaBuck™	Saving our world, 1mW/W/kW at a time™	TRUECURRENT®*
Dual Cool™	MICROCOUPLER™	SignalWise™	μSerDes™
EcoSPARK®	MicroFET™	SmartMax™	 SerDes™
EfficientMax™	MicroPak™	SMART START™	UHC®
ESBC™	MicroPak2™	Solutions for Your Success™	Ultra FRFET™
 ®	MillerDrive™	SPM®	UniFET™
Fairchild®	MotionMax™	STEALTH™	VCX™
Fairchild Semiconductor®	MotionGrid®	SuperFET®	VisualMax™
FACT Quiet Series™	MTi®	SuperSOT™-3	VoltagePlus™
FACT®	MTx®	SuperSOT™-6	XS™
FastvCore™	MVN®	SuperSOT™-8	Xsens™
FETBench™	mWSaver®	SupreMOS®	仙童®
FPS™	OptoHiT™	SyncFET™	
	OPTOLOGIC®	Sync-Lock™	

\* Trademarks of System General Corporation, used under license by Fairchild Semiconductor.

## DISCLAIMER

FAIRCHILD SEMICONDUCTOR RESERVES THE RIGHT TO MAKE CHANGES WITHOUT FURTHER NOTICE TO ANY PRODUCTS HEREIN TO IMPROVE RELIABILITY, FUNCTION, OR DESIGN. TO OBTAIN THE LATEST, MOST UP-TO-DATE DATASHEET AND PRODUCT INFORMATION, VISIT OUR WEBSITE AT [HTTP://WWW.FAIRCHILDSEMI.COM](http://www.fairchildsemi.com). FAIRCHILD DOES NOT ASSUME ANY LIABILITY ARISING OUT OF THE APPLICATION OR USE OF ANY PRODUCT OR CIRCUIT DESCRIBED HEREIN; NEITHER DOES IT CONVEY ANY LICENSE UNDER ITS PATENT RIGHTS, NOR THE RIGHTS OF OTHERS. THESE SPECIFICATIONS DO NOT EXPAND THE TERMS OF FAIRCHILD'S WORLDWIDE TERMS AND CONDITIONS, SPECIFICALLY THE WARRANTY THEREIN, WHICH COVERS THESE PRODUCTS.

## AUTHORIZED USE

Unless otherwise specified in this data sheet, this product is a standard commercial product and is not intended for use in applications that require extraordinary levels of quality and reliability. This product may not be used in the following applications, unless specifically approved in writing by a Fairchild officer: (1) automotive or other transportation, (2) military/aerospace, (3) any safety critical application – including life critical medical equipment – where the failure of the Fairchild product reasonably would be expected to result in personal injury, death or property damage. Customer's use of this product is subject to agreement of this Authorized Use policy. In the event of an unauthorized use of Fairchild's product, Fairchild accepts no liability in the event of product failure. In other respects, this product shall be subject to Fairchild's Worldwide Terms and Conditions of Sale, unless a separate agreement has been signed by both Parties.

## ANTI-COUNTERFEITING POLICY

Fairchild Semiconductor Corporation's Anti-Counterfeiting Policy. Fairchild's Anti-Counterfeiting Policy is also stated on our external website, [www.fairchildsemi.com](http://www.fairchildsemi.com), under Terms of Use

Counterfeiting of semiconductor parts is a growing problem in the industry. All manufacturers of semiconductor products are experiencing counterfeiting of their parts. Customers who inadvertently purchase counterfeit parts experience many problems such as loss of brand reputation, substandard performance, failed applications, and increased cost of production and manufacturing delays. Fairchild is taking strong measures to protect ourselves and our customers from the proliferation of counterfeit parts. Fairchild strongly encourages customers to purchase Fairchild parts either directly from Fairchild or from Authorized Fairchild Distributors who are listed by country on our web page cited above. Products customers buy either from Fairchild directly or from Authorized Fairchild Distributors are genuine parts, have full traceability, meet Fairchild's quality standards for handling and storage and provide access to Fairchild's full range of up-to-date technical and product information. Fairchild and our Authorized Distributors will stand behind all warranties and will appropriately address any warranty issues that may arise. Fairchild will not provide any warranty coverage or other assistance for parts bought from Unauthorized Sources. Fairchild is committed to combat this global problem and encourage our customers to do their part in stopping this practice by buying direct or from authorized distributors.

## PRODUCT STATUS DEFINITIONS

### Definition of Terms

Datasheet Identification	Product Status	Definition
Advance Information	Formative / In Design	Datasheet contains the design specifications for product development. Specifications may change in any manner without notice.
Preliminary	First Production	Datasheet contains preliminary data; supplementary data will be published at a later date. Fairchild Semiconductor reserves the right to make changes at any time without notice to improve design.
No Identification Needed	Full Production	Datasheet contains final specifications. Fairchild Semiconductor reserves the right to make changes at any time without notice to improve the design.
Obsolete	Not In Production	Datasheet contains specifications on a product that is discontinued by Fairchild Semiconductor. The datasheet is for reference information only.

Rev. I77