



Size: 1.0in x 1.0in x 0.39in (25.4mm x 25.4mm x 9.9mm)

FEATURES

- 20 Watts Maximum Output Power
- Single and Dual Outputs
- Industry Standard Pin-Out
- Small Size and Low Profile: 1.0" x 1.0" x 0.39"
- 4:1 Ultra Wide Input Voltage Range
- High Efficiency up to 91%
- 1600VDC I/O Isolation
- Ultra Low Quiescent Current
- Fixed Switching Frequency
- Remote ON/OFF Control
- Over Voltage, Over Load, and Short Circuit Protected
- Six-Sided Continuous Shield
- EMI Meets EN55022 Class A Without External Filter
- CE Marked
- UL60950-1, EN60950-1, and IEC60950-1 Safety Approvals
- Compliant to RoHS II & REACH

DESCRIPTION

The JFCW20 series of DC/DC power converters provides 20 watts of output power in a 1.0 x 1.0 x 0.39 inch industry standard package and footprint. This series has single and dual output models with 4:1 ultra wide input voltage ranges of 9-36VDC and 18-75VDC. Some features include high efficiency, ultra low quiescent current, 1600VDC I/O isolation, remote ON/OFF, and trimmable output voltage. This series is also protected against over voltage, over current, input under voltage, and short circuit conditions. All models are RoHS compliant and have UL60950-1, EN60950-1, and IEC60950-1 safety approvals.

- OPTIONS**
- Remote ON/OFF
 - Heatsink
 - Operating Temperature
- APPLICATIONS**
- Wireless Networks
 - Telecom / Datacom
 - Industry Control Systems
 - Distributed Power Architectures
 - Semiconductor Equipment
 - Automation
 - Measurement
 - IPC

MODEL SELECTION TABLE

Single Output Models									
Model Number	Input Voltage Range	Output Voltage	Output Current		No Load Input Current	Efficiency	Maximum Capacitive Load ⁽¹⁾	Output Power	Ripple & Noise
			Min Load	Max Load					
JFCW24S3.3-20	24 VDC (9 – 36 VDC)	3.3 VDC	0mA	4500mA	10mA	89%	7000µF	20W	75mVp-p
JFCW24S5-20		5 VDC	0mA	4000mA	10mA	89%	5000µF		
JFCW24S12-20		12 VDC	0mA	1670mA	6mA	89%	850µF		
JFCW24S15-20		15 VDC	0mA	1330mA	6mA	89%	700µF		
JFCW24S24-20		24VDC	0mA	833mA	10mA	91%	220µF		
JFCW48S3.3-20	48 VDC (18 – 75 VDC)	3.3 VDC	0mA	4500mA	10mA	90%	7000µF	20W	75mVp-p
JFCW48S5-20		5 VDC	0mA	4000mA	10mA	90%	5000µF		
JFCW48S12-20		12 VDC	0mA	1670mA	4mA	89%	850µF		
JFCW48S15-20		15 VDC	0mA	1330mA	4mA	90%	700µF		
JFCW48S24-20		24VDC	0mA	833mA	8mA	91%	220µF		

MODEL SELECTION TABLE

Dual Output Models									
Model Number	Input Voltage Range	Output Voltage	Output Current		No Load Input Current	Efficiency	Maximum Capacitive Load ⁽¹⁾	Output Power	Ripple & Noise
			Min Load	Max Load					
JFCW24D12-20	24 VDC (9 – 36 VDC)	±12 VDC	0mA	±833mA	6mA	89%	±500µF	20W	100mVp-p
JFCW24D15-20		±15 VDC	0mA	±667mA	6mA	90%	±350µF		
JFCW24D24-20		±24 VDC	0mA	±417mA	12mA	91%	±100µF		
JFCW48D12-20	48 VDC (18 – 75 VDC)	±12 VDC	0mA	±833mA	4mA	89%	±500µF	20W	100mVp-p
JFCW48D15-20		±15 VDC	0mA	±667mA	4mA	90%	±350µF		
JFCW48D24-20		±24 VDC	0mA	±417mA	10mA	91%	±100µF		

SPECIFICATIONS

All specifications are based on 25°C, Nominal Input Voltage, and Maximum Output Current unless otherwise noted.
 We reserve the right to change specifications based on technological advances.

SPECIFICATION	TEST CONDITIONS		Min	Typ	Max	Unit
INPUT SPECIFICATIONS						
Input Voltage Range	24VDC Nominal Input Models		9	24	36	VDC
	48VDC Nominal Input Models		18	48	75	
Input Surge Voltage (1 sec. max.)	24VDC Nominal Input Models				50	VDC
	48VDC Nominal Input Models				100	
Start-Up Voltage	24VDC Nominal Input Models				9	VDC
	48VDC Nominal Input Models				18	
Shutdown Voltage	24VDC Nominal Input Models		7.5	8	8.8	VDC
	48VDC Nominal Input Models		15.5	16	17.5	
Input Reflected Ripple Current	Nominal Vin and Full Load			30		mAp-p
Input Filter			Pi Type			
OUTPUT SPECIFICATIONS						
Output Voltage			See Table			
Voltage Accuracy			-1.0		+1.0	%
Line Regulation	Low Line to High Line at Full Load	Single	-0.2		+0.2	%
		Dual	-0.5		+0.5	
Load Regulation	No Load to Full Load	Single	-0.2		+0.2	%
		Dual	-1.0		+1.0	
	10% Load to 90% Load	Single	-0.1		+0.1	
		Dual	-0.8		+0.8	
Voltage Adjustability ⁽²⁾	Single Outputs	24Vout	-10		+20	%
		Others	-10		+10	
Output Power			See Table			
Output Current			See Table			
Maximum Capacitive Load			See Table			
Ripple & Noise (20MHz bandwidth)	With a 1µF M/C X7R and a 10µF T/C	3.3V, 5V, 12V, and 24V		75		mVp-p
	With 2pcs of 6.8µF/50V X7R MLCC	24V		75		
	With a 1µF M/C X7R and a 10µF T/C for each output	±12V and ±15V		100		
	With a 4.7µF/50V X7R MLCC for each output	±24V		100		
Transient Response Recovery Time	25% Load Step Change			250		µS
Start-Up Time	Constant Resistive Load	Power Up			30	mS
		Remote ON/OFF			30	
Temperature Coefficient			-0.02		+0.02	%/°C
Cross Regulation	Asymmetrical load 25%/100% FL, Dual Models		-5.0		+5.0	%
REMOTE ON/OFF CONTROL⁽³⁾						
Positive Logic (Standard)	DC-DC ON		Open or 3~15VDC			
	DC-DC OFF		Short or 0~1.2VDC			
Negative Logic (Optional)	DC-DC ON		Short or 0~1.2VDC			
	DC-DC OFF		Open or 3~15VDC			
Input Current of CTRL Pin			-0.5		1.0	mA
Remote OFF Input Current				2.0		mA
PROTECTION						
Short Circuit Protection			Continuous, Automatic Recovery			
Over Load Protection	%Iout rated; Hiccup Mode			150		%
Over Voltage Protection	3.3V Output Models		3.7		5.4	VDC
	5V Output Models		5.6		7.0	
	12V Output Models		13.5		19.6	
	15V Output Models		16.8		20.5	
	24V Output Models		29.1		32.5	
ENVIRONMENTAL SPECIFICATIONS						
Operating Ambient Temperature	Standard	With derating	-40		+101	°C
	M3 Version	With derating	+55		+101	
Maximum Case Temperature					105	°C
Storage Temperature			-55		+125	°C
Relative Humidity			5		95	%RH
Thermal Impedance ⁽⁴⁾	Without Heat-Sink			17.6		°C/W
	With Heat-Sink			14.8		
Thermal Shock			MIL-STD-810F			
Vibration			MIL-STD-810F			
MTBF	MIL-HDBK-217F, Full Load			1,469,000		Hours

SPECIFICATIONS

All specifications are based on 25°C, Nominal Input Voltage, and Maximum Output Current unless otherwise noted.
We reserve the right to change specifications based on technological advances.

SPECIFICATION	TEST CONDITIONS		Min	Typ	Max	Unit
GENERAL SPECIFICATIONS						
Efficiency			See Table			
Switching Frequency	3.3V Output Models, 5V Output Models		248	275	303	kHz
	Others		297	330	363	
Isolation Voltage	1 minute	Input to Output	1600			VDC
		Input (Output) to Case	1000			
Isolation Resistance	500VDC		1			GΩ
Isolation Capacitance					1500	pF
PHYSICAL SPECIFICATIONS						
Weight			0.53oz (15g)			
Dimensions (L x W x H)			1in x 1in x 0.39in (25.4mm x 25.4mm x 9.9mm)			
Case Material			Nickel-Coated Copper			
Base Material			FR4 PCB			
Potting Material			Silicone (UL94 V-0)			
Shielding			Six-Sided Continuous Shield			
SAFETY CHARACTERISTICS						
Safety Approvals			UL60950-1, EN60950-1, IEC60950-1			UL: E193009 CB: UL (Demko)
EMI ⁽⁵⁾	EN55022	Without external components	Class A			
		With external components	Class B			
ESD	EN61000-4-2	Air ±8kV and Contact ±6kV	Perf. Criteria A			
Radiated Immunity	EN61000-4-3	10 V/m	Perf. Criteria A			
Fast Transient ⁽⁶⁾	EN61000-4-4	±2kV	Perf. Criteria A			
Surge ⁽⁶⁾	EN61000-4-5	±2kV	Perf. Criteria A			
Conducted Immunity	EN61000-4-6	10Vr.m.s	Perf. Criteria A			
Power Frequency Magnetic Field	EN61000-4-8	100A/m Continuous; 1000A/m 1 sec.	Perf. Criteria A			

NOTES

1. Tested by minimum input and constant resistive load.
2. Trimming allows the user to increase or decrease the output voltage set point of the module. This is accomplished by connecting an external resistor between the Trim pin and either +Vout pin or -Vout pin.
3. The ON/OFF control pin is referenced to -Vin. To order Negative Logic Remote ON/OFF add the suffix "R" to the model number.
4. Heatsink is optional and P/N: 7G-0047C-F. See "Model Number Setup" on page 4 for more information.
5. EN55022
 1. To meet Class A the module needs no external components.
 2. To meet Class B please refer to the filter suggestion on page 4.
6. An external input filter capacitor is required if the module has to meet EN61000-4-4, EN61000-4-5. The suggested filter capacitor is Nippon chemicon KY series, 220µF/100V.

CAUTION: This power module is not internally fused. An input line fuse must always be used.

**Due to advances in technology, specifications subject to change without notice.*

DERATING CURVES

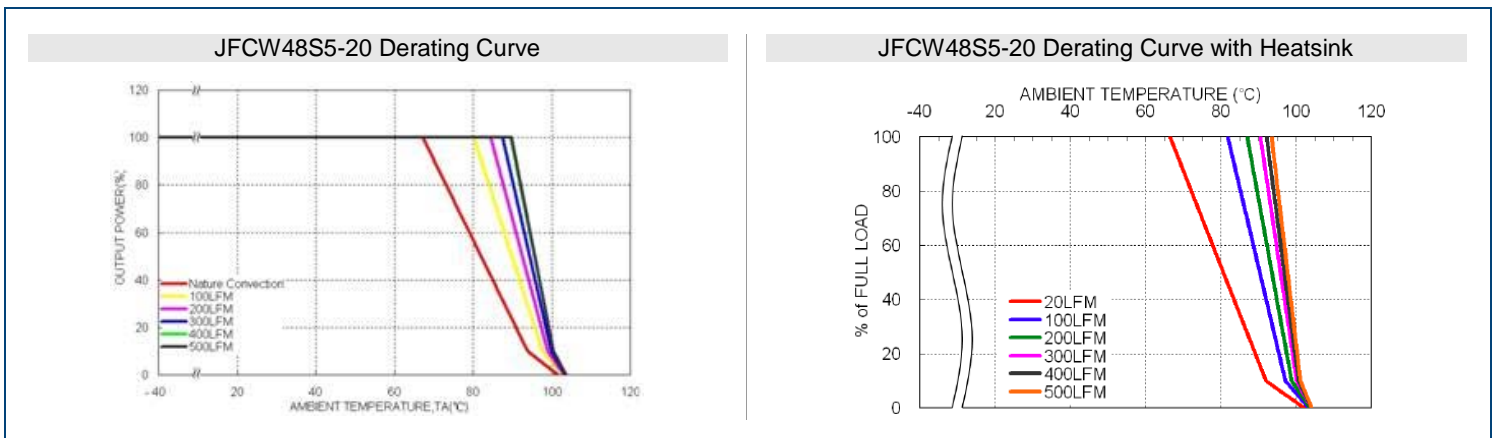

EFFICIENCY GRAPHS

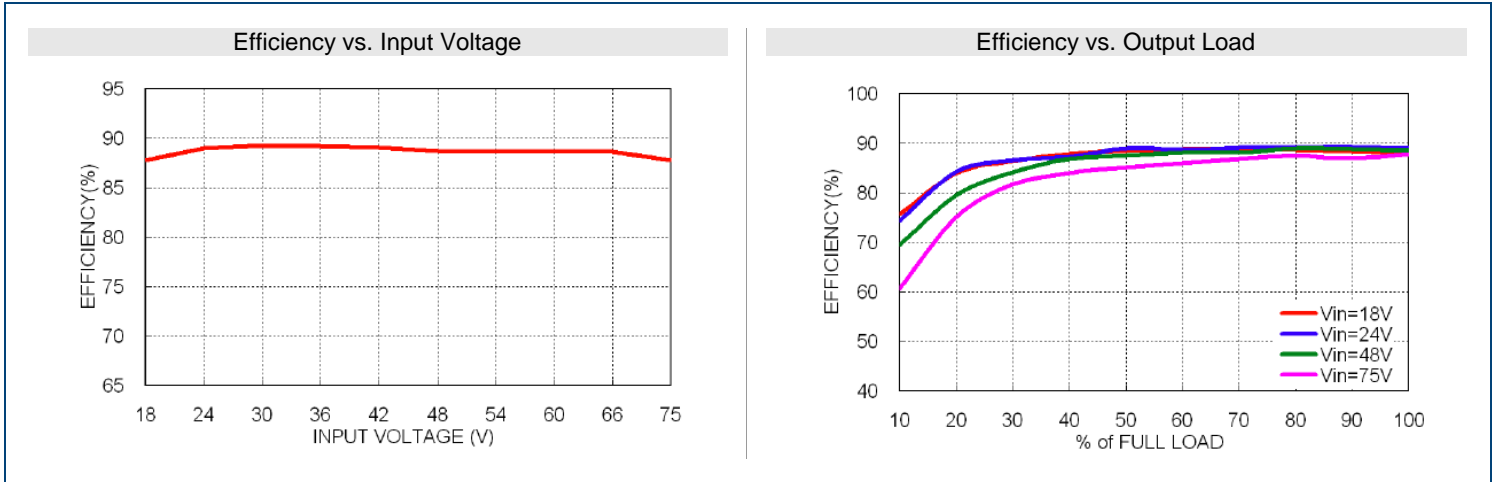

MECHANICAL DRAWINGS

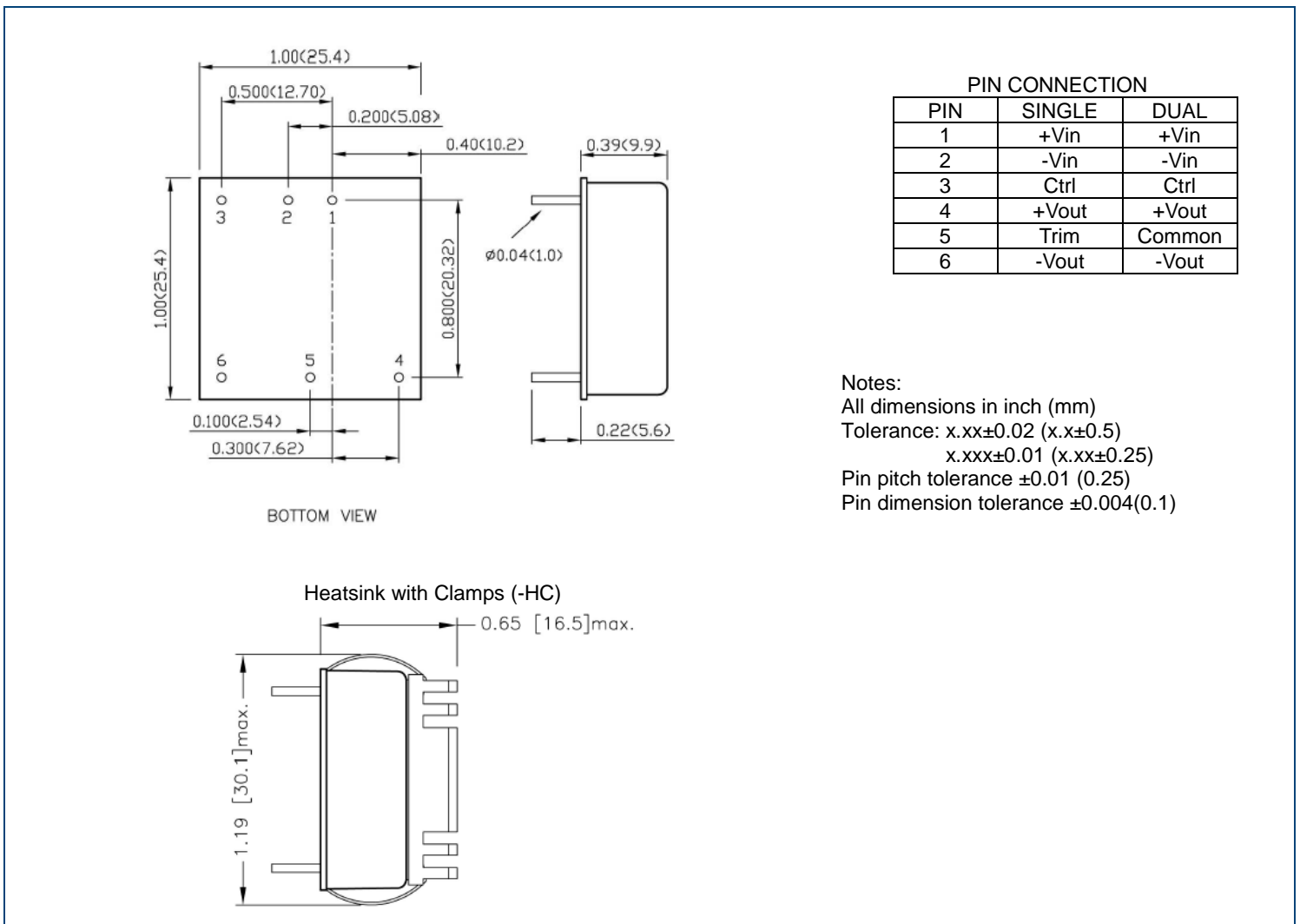

RECOMMENDED PAD LAYOUT

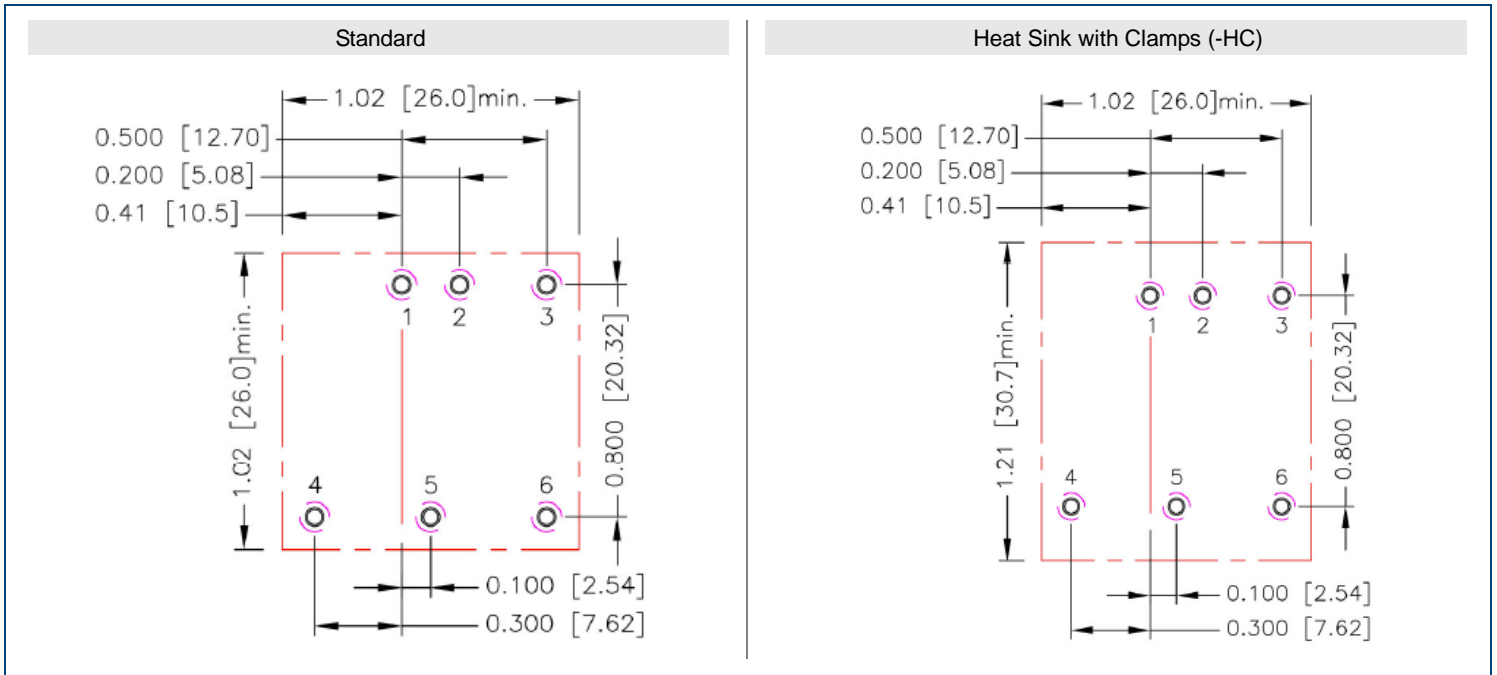

All dimensions in inch [mm]
 Pad size (lead free recommended)
 Through Hole 1.2.3.4.5.6: $\Phi 0.051$ [1.30]
 Top View Pad 1.2.3.4.5.6: $\Phi 0.065$ [1.63]
 Bottom View Pad 1.2.3.4.5.6: $\Phi 0.102$ [2.60]

RECOMMENDED FILTERS

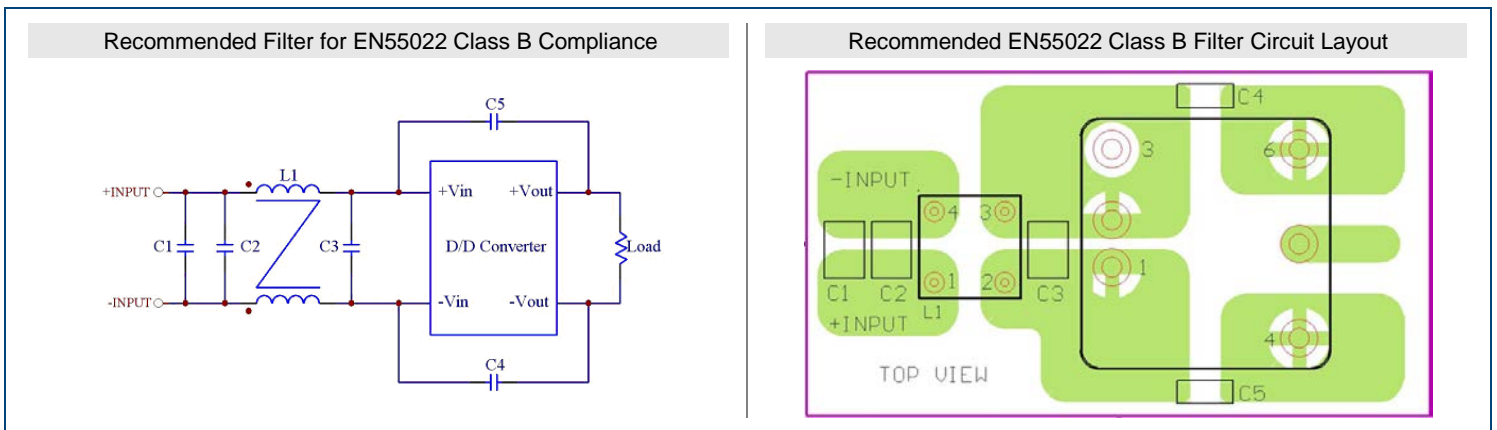

The components used in the figure above are as follows:

	C1, C2	C2	C3	C4 & C5	L1
JFCW-24xxx-20	4.7 μ F/50V 1812 MLCC	N/A	N/A	470pF/2KV 1808 MLCC	325 μ H Common Choke PMT-050
JFCW-48xxx-20	2.2 μ F/100V 1812 MLCC	2.2 μ F/100V 1812 MLCC	2.2 μ F/100V 1812 MLCC	1000pF/2KV 1808 MLCC	325 μ H Common Choke PMT-050

FUSE CONSIDERATION

This power module is not internally fused. An input line fuse must always be used. This encapsulated power module can be used in a variety of applications, ranging from simple stand-alone operation to an integrated part of sophisticated power architecture. To maximum flexibility, internal fusing is not included; however, to achieve maximum safety and system protection, always use an input line fuse. The suggested input line fuse below:

Model	Fuse Rating (A)	Fuse Type
JFCW24Sx-20 & JFCW24Sx-20	4A	Slow-Blow
JFCW48Sx-20 & JFCW48Sx-20	2A	Slow-Blow

The table based on the information provided in this data sheet on inrush energy and maximum DC input current at low Vin.

THERMAL CONSIDERATION

This power module operates in a variety of thermal environments, however, sufficient cooling should be provided to help ensure reliable operation of the unit. Heat is removed by conduction, convection, and radiation to the surrounding environment. Proper cooling can be verified by measuring the point in the figure below. The temperature at this location should not exceed 105°C. When operating, adequate cooling must be provided to maintain the test point temperature at or below 105°C. Although the maximum point temperature of the power modules is 105°C, you can limit this temperature to a lower value for extremely high reliability.

- Thermal test condition with vertical direction by natural convection (20LFM).

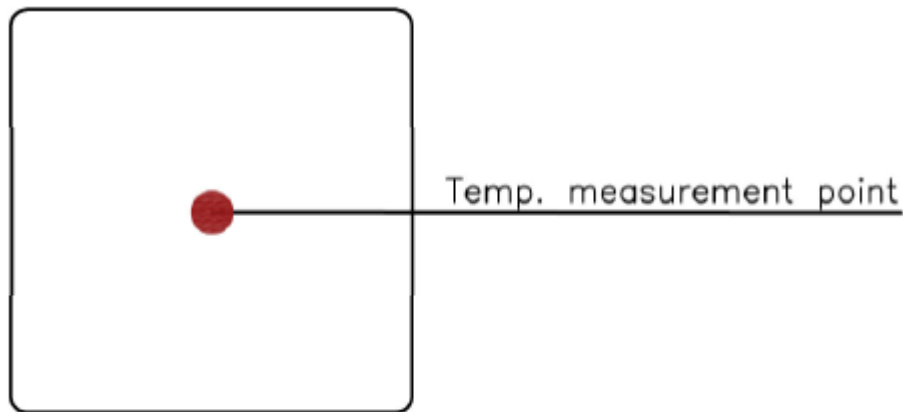

TOP VIEW

OUTPUT VOLTAGE ADJUSTMENT

Output voltage set point adjustment allows the user to increase or decrease the output voltage set point of the module. This is accomplished by connecting an external resistor between the Trim pin and either the +Output or -Output pins. With an external resistor between the Trim and -Output pin, the output voltage set point increases. With an external resistor between the Trim and +Output pin, the output voltage set point decreases. The external Trim resistor needs to be at least 1/16W of rated power.

Trim Up Equation

$$R_U = \left[\frac{G \times L}{(V_{O,up} - L - K)} - H \right] \Omega$$

Trim Down Equation

$$R_D = \left[\frac{(V_{O,down} - L) \times G}{(V_O - V_{O,down})} - H \right] \Omega$$

Module	G	H	K	L
JFCWxxS3.3-20	5110	2050	0.8	2.5
JFCWxxS5-20	5110	2050	2.5	2.5
JFCWxxS12-20	10000	5110	9.5	2.5
JFCWxxS15-20	10000	5110	12.5	2.5
JFCWxxS24-20	56000	13000	21.5	2.5

External Output Trimming

Output can be externally trimmed by using the method shown below.

Trim-Up

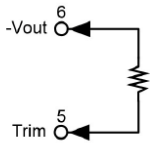

3.3VDC Models

ΔV (%)	1	2	3	4	5	6	7	8	9	10
Vout (V)	3.333	3.366	3.399	3.432	3.465	3.498	3.531	3.564	3.597	3.630
RU (kΩ)	385.071	191.511	126.990	94.730	75.374	62.470	53.253	46.340	40.963	36.662

5VDC Models

ΔV (%)	1	2	3	4	5	6	7	8	9	10
Vout (V)	5.050	5.100	5.150	5.200	5.250	5.300	5.350	5.400	5.450	5.500
RU (kΩ)	253.450	125.700	83.117	61.825	49.050	40.533	34.450	29.888	26.339	23.500

12VDC Models

ΔV (%)	1	2	3	4	5	6	7	8	9	10
Vout (V)	12.120	12.240	12.360	12.480	12.600	12.720	12.840	12.960	13.080	13.200
RU (kΩ)	203.223	99.057	64.334	46.973	36.557	29.612	24.625	20.932	18.038	15.723

15VDC Models

ΔV (%)	1	2	3	4	5	6	7	8	9	10
Vout (V)	15.150	15.300	15.450	15.600	15.750	15.900	16.050	16.200	16.350	16.500
RU (kΩ)	161.557	78.223	54.446	36.557	28.223	22.668	18.700	15.723	13.409	11.557

24VDC Models

ΔV (%)	1	2	3	4	5	6	7	8	9	10
Vout (V)	24.240	24.480	24.720	24.960	25.200	25.440	25.680	25.920	26.160	26.400
RU (kΩ)	570.333	278.667	181.444	132.833	103.667	84.222	70.333	59.917	51.815	45.333
ΔV (%)	11	12	13	14	15	16	17	18	19	20
Vout (V)	26.640	26.880	27.120	27.360	27.600	27.840	28.080	28.320	28.560	28.800
RU (kΩ)	40.030	35.611	31.872	28.667	25.889	23.458	21.314	19.407	17.702	16.167

Trim-Down

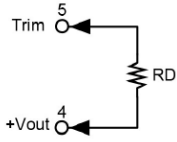

3.3VDC Models

ΔV (%)	1	2	3	4	5	6	7	8	9	10
Vout (V)	3.267	3.234	3.201	3.168	3.135	3.102	3.069	3.036	3.003	2.970
RU (k Ω)	116.719	54.779	34.133	23.810	17.616	13.486	10.537	8.325	6.604	5.228

5VDC Models

ΔV (%)	1	2	3	4	5	6	7	8	9	10
Vout (V)	4.950	4.900	4.850	4.800	4.750	4.700	4.650	4.600	4.550	4.500
RU (k Ω)	248.340	120.590	78.007	56.715	43.940	35.423	29.340	24.778	21.229	18.390

12VDC Models

ΔV (%)	1	2	3	4	5	6	7	8	9	10
Vout (V)	11.880	11.760	11.640	11.520	11.400	11.280	11.160	11.040	10.920	10.800
RU (k Ω)	776.557	380.723	248.779	182.807	143.223	116.834	97.985	83.848	72.853	64.057

15VDC Models

ΔV (%)	1	2	3	4	5	6	7	8	9	10
Vout (V)	14.850	14.700	14.550	14.400	14.250	14.100	13.950	13.800	13.650	13.500
RU (k Ω)	818.223	401.557	262.668	193.223	151.557	123.779	103.938	89.057	77.483	68.223

24VDC Models

ΔV (%)	1	2	3	4	5	6	7	8	9	10
Vout (V)	23.760	23.520	23.280	23.040	22.800	22.560	22.320	22.080	21.840	21.600
RU (k Ω)	4947.667	2439.333	1603.222	1185.167	934.333	767.111	647.667	558.083	488.407	432.667

MODEL NUMBER SETUP

JFCW	48	S	5	-	20	R
Series Name	Input Power	# of Outputs	Output Voltage		Output Power	Remote On/Off Options
	24: 9-36VDC 48: 18-75VDC	S: Single D: Dual	3.3: 3.3VDC 5: 5VDC 12: 12VDC 15: 15VDC 24: 24VDC 12: ± 12 VDC 15: ± 15 VDC 24: ± 24 VDC		20: 20W	None: Positive ON/OFF (standard) R: Negative Remote ON/OFF D: Without ON/OFF G: Without ON/OFF & Trim Pin F: Positive Remote ON/OFF without Trim Pin RF: Negative Remote ON/OFF without Trim Pin

HS	M3
Heatsink Option	Operating Temperature Option
None: None HC: Heat-sink w. Clamp	Blank: Standard -40~101°C With Derating M3: M3 Version -55~101°C With Derating

COMPANY INFORMATION

Wall Industries, Inc. has created custom and modified units for over 50 years. Our in-house research and development engineers will provide a solution that exceeds your performance requirements on-time and on budget. Our ISO9001-2008 certification is just one example of our commitment to producing a high quality, well-documented product for our customers.

Our past projects demonstrate our commitment to you, our customer. Wall Industries, Inc. has a reputation for working closely with its customers to ensure each solution meets or exceeds form, fit and function requirements. We will continue to provide ongoing support for your project above and beyond the design and production phases. Give us a call today to discuss your future projects.

Contact **Wall Industries** for further information:

Phone: ☎ (603)778-2300
Toll Free: ☎ (888)597-9255
Fax: ☎ (603)778-9797
E-mail: sales@wallindustries.com
Web: www.wallindustries.com
Address: 37 Industrial Drive
Exeter, NH 03833