

Specification

BTHQ 128128AJA-FETF-06-LEDWHITE-COG_NT

Doc. No.: MSGF9622-09

Version April 2008

Supplied by:

Midas Components Limited, Electra House, 32 Southtown Road, Great Yarmouth, Norfolk, NR31 0DU

Telephone: +44 (0)1493 602602

Fax: +44 (0)1493 665111

Email: sales@midasdisplays.com

Website: www.midasdisplays.com

REVISION HISTORY:				
Revision	Date	Description	Written By	Approved By
1.0	28-Apr.-2008	New Release (Modified from MSGF9622-07 by removing touch panel).	DengWen	Justin Yeap

Supplied by:

Midas Components Limited, Electra House, 32 Southtown Road, Great Yarmouth, Norfolk, NR31 0DU

Telephone: +44 (0)1493 602602

Fax: +44 (0)1493 665111

Email: sales@midasdisplays.comWebsite: www.midasdisplays.com

CONTENTS

- 1.0 GENERAL SPECIFICATION**
- 2.0 LCM NUMBERING SYSTEM**
- 3.0 OUTLINE DRAWING**
- 4.0 INTERFACE PIN DESCRIPTION**
- 5.0 BLOCK DIAGRAM**
- 6.0 OPERATING PRINCIPLE & DRIVING METHOD**
- 7.0 ABSOLUTE MAXIMUM RATINGS**
- 8.0 ELECTRICAL CHARACTERISTICS**
- 9.0 ELECTRO-OPTICAL CHARACTERISTICS**
- 10.0 BACKLIGHT SPECIFICATION**
- 11.0 STANDARD SPECIFICATION FOR RELIABILITY**
- 12.0 QUALITY ASSURANCE**
- 13.0 PRECAUTIONS FOR USING LCD MODULE**
- 14.0 LOT NUMBERING SYSTEM**
- 15.0 PACKAGING STANDARD**
- 16.0 RoHS COMPLIANT PRODUCT**
- 17.0 LIMITED WARRANTY**
- 18.0 MANUFACTURER CONTACT**

Supplied by:

Midas Components Limited, Electra House, 32 Southtown Road, Great Yarmouth, Norfolk, NR31 0DU

Telephone: +44 (0)1493 602602

Fax: +44 (0)1493 665111

Email: sales@midasdisplays.com

Website: www.midasdisplays.com

1.0 GENERAL SPECIFICATION

Item	Contents	Unit
LCD type	FSTN Positive Transflective	-
Driving Scheme	1/128 Duty 1/12 Bias	-
LCD controller/ driver	NT7506H-BDT	-
Module size (W×H×T)	75.0 × 135.0× 7.8	mm
Viewing area (W×H)	69.0 × 69.0	mm
Viewing angle	6	O'clock
Number of dots	128 × 128	dots
Dot size (W×H)	0.48 × 0.48	mm
Dot pitch (W×H)	0.495 × 0.495	mm
Backlight	LED	-
Backlight color	White	-
Operating temperature	-20 ~ 70	°C
Storage temperature	-30 ~ 80	°C

2.0 LCM NUMBERING SYSTEM

JIC - M S G F 9622 - 09
 (1) (2) (3) (4) (5) (6) (7)

- (1) JIC symbol
- (2) Custom-made LCD module
- (3) Display type (T: TN, S: STN/FSTN, H: HTN, C: CSTN)
- (4) Controller/driver package type (G: COG, T: TCP, F: COF, B: COB)
- (5) Interface connection type (F: FPC/COF, H: heatseal, Z: zebra connector, P: Pin, T: TAB)
- (6) Serial number
- (7) Product revision

Supplied by:

Midas Components Limited, Electra House, 32 Southtown Road, Great Yarmouth, Norfolk, NR31 0DU

Telephone: +44 (0)1493 602602

Fax: +44 (0)1493 665111

Email: sales@midasdisplays.com

Website: www.midasdisplays.com

3.0 OUTLINE DRAWING

BATRON

PIN ASSIGNMENT:

PIN	SYMBOL
1	A
2	K
3	A
4	K
5	NC
6	V0
7	V1
8	V2
9	V3
10	V4
11	C4+
12	C2-
13	C2+
14	C1+
15	C1-
16	C3+
17	C5+
18	VOUT
19	VSS
20	VDD
21	DB7
22	DB6
23	DB5
24	DB4
25	DB3
26	DB2
27	DB1
28	DB0
29	RD
30	WR
31	RS
32	RESETB
33	CSB
34	PS1
35	PS0

B745195
 BPH0 128128MA-FET-06-LEDWHITE-COG
 YINMO00XX
 LIGHT SHIELDING TAPE WITH DATE CODE

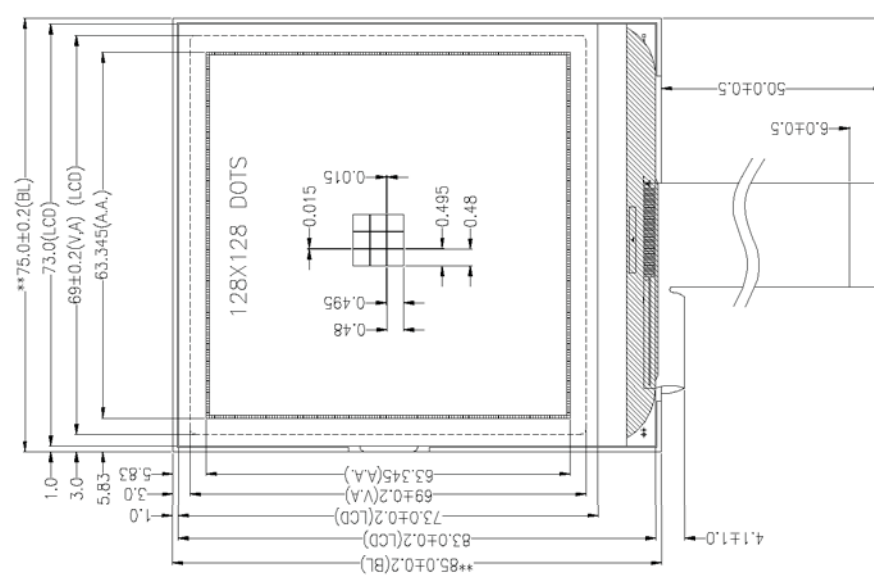
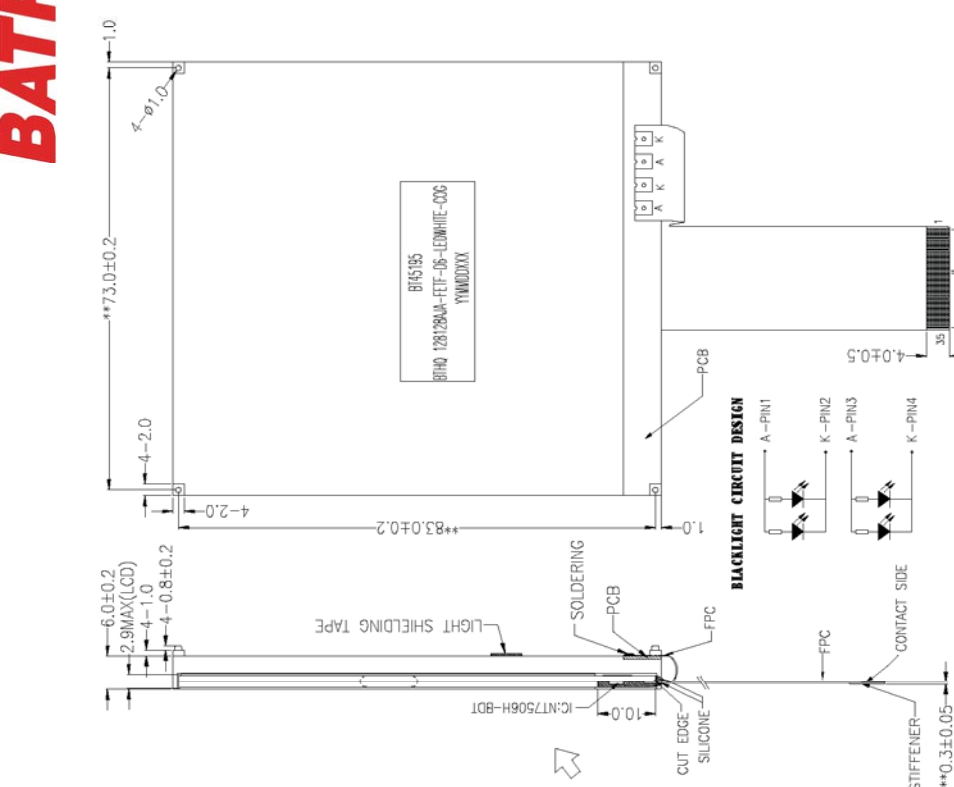

NOTE:
 1. ? SPECIAL DIMENSION (PPK/CPK DATA NEEDED > 1.67)
 2. ** CRITICAL DIMENSION
 3. ALL UNMARKED "0" OR "*" DIMENSIONS ARE REFERENCE DIMENSIONS AND NO MEASUREMENT NEEDED.
 4. VDD(TYP) = 3.3V (THIS VALUE WILL BE USED FOR JIC FUNCTIONAL TESTING SETTING, PLEASE SPECIFY IF DIFFERENT FROM THIS VALUE)
 5. BACKLIGHT: WHITE, FPCS VF=3.3±0.2@IF=15mA/FCS, brightness: 200cd/m²
 6. I.C. VERSION: VER 2.2 (2007/9/13)
 Green/Red compliant product Yes No

QTN No.	0845-05	TYPE	FSTN-POSITIVE TRANSPARENT
CUSTOMER NAME	DATA MODUL	VIEWING DIRECTION	6 O'clock
CUSTOMER P/N	COG 128X128	DRIVE CONDITION	$\sim 12.5V$ 1/128 duty 1/12 Bias
		Top	$-20^{\circ}C \sim +70^{\circ}C$
		Tst	$-30^{\circ}C \sim +80^{\circ}C$
		REVISION RECORD	REVISION RECORD
		REVISOR	YANGLIANG
		DATE	071219
		UNIT	mm
		THROW OFF IP	071219
		UNSPRDFD TOLERANCE	± 0.2
		THROW ANGLE	
		CUSTOMER ORDERING NO.	JIC-MSGF9622-09
		MODEL NO.	JIC-MSGF9622-09
		VERSION	A
		DWG-MSGF9622-09-VERA	
		DATE	071219
		APPROD BY	YANGLIANG
		DATE	071219
		CHECK BY	YANGLIANG
		DATE	071219
		DRAWING BY	YANGLIANG
		DATE	071219
		PAGE	3-1

Supplied by:
 Midas Components Limited, Electra House, 32 Southtown Road, Great Yarmouth, Norfolk, NR31 0DU
 Telephone: +44 (0)1493 602602
 Fax: +44 (0)1493 665111
 Email: sales@midasdisplays.com
 Website: www.midasdisplays.com

4.0 INTERFACE PIN DESCRIPTION

Pin No.	Symbol	Pin Description
1, 3	A	LED anode supply
2, 4	K	LED cathode supply
5	NC	NO Connection
6 ~10	V0 ~ V4	LCD driver supply voltage
11	C4+	Capacitor for voltage converter.
12	C2-	Capacitor for voltage converter.
13	C2+	Capacitor for voltage converter.
14	C1+	Capacitor for voltage converter.
15	C1-	Capacitor for voltage converter.
16	C3+	Capacitor for voltage converter.
17	C5+	Capacitor for voltage converter.
18	VOUT	Voltage converter input/ output pin.
19	VSS	Ground
20	VDD	Power supply
21~ 28	DB7 ~ DB0	8 bits data bus
29	RD	Read control input
30	WR	Write control input
31	RS	Determines whether the data bits are data or a command. RS= "H" display data RS= "L" control data
32	RESETB	Reset input . REST= "L" the setting are initialised.
33	CSB	Chip select pin
34	PS1	6800-series/ 8080-series interface select pin.
35	PS0	Parallel/ serial data input select pin.

Supplied by:

Midas Components Limited, Electra House, 32 Southtown Road, Great Yarmouth, Norfolk, NR31 0DU

Telephone: +44 (0)1493 602602

Fax: +44 (0)1493 665111

Email: sales@midasdisplays.comWebsite: www.midasdisplays.com

5.0 BLOCK DIAGRAM

5.1 Interface with 6800-series MPU

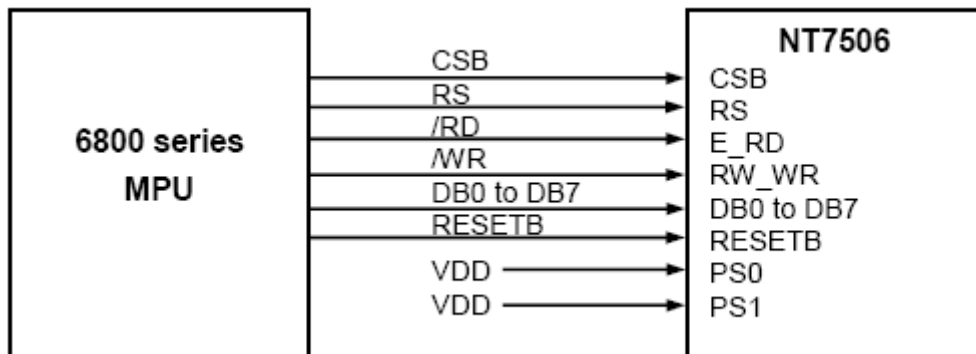

5.2 Interface with 8080-series MPU

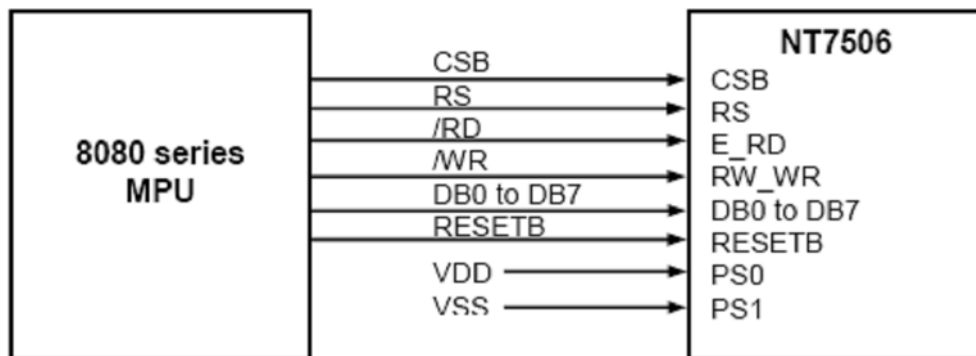

Supplied by:

Midas Components Limited, Electra House, 32 Southtown Road, Great Yarmouth, Norfolk, NR31 0DU

Telephone: +44 (0)1493 602602

Fax: +44 (0)1493 665111

Email: sales@midasdisplays.com

Website: www.midasdisplays.com

6.0 OPERATING PRINCIPLE & DRIVING METHOD

- 6.1 Please refer to NT7506 V2.2 IC data sheet.
- 6.2 Instruction Description (based on IC spec ver as stated in 6.1 where the product is designed). This instruction description is for reference only. Customer is encouraged to always refer to the latest IC specification.

Instruction	RS	RW	DB7	DB6	DB5	DB4	DB3	DB2	DB1	DB0	Description
Read display data	1	1	Read data								Read data from DDRAM
Write display data	1	0	Write data								Write data into DDRAM
Read status	0	1	BUSY	ON/OFF	RES	0	0	0	1	0	Read the internal status
ICON control register ON/OFF	0	0	1	0	1	0	0	0	1	ICON	ICON=0: ICON disable (default) ICON=1: ICON enable & set the page address to 16
Set page address	0	0	1	0	1	1	P3	P2	P1	P0	Set page address
Set column address MSB	0	0	0	0	0	1	0	Y7	Y6	Y5	Set column address MSB
Set column address LSB	0	0	0	0	0	0	Y4	Y3	Y2	Y1	Set column address LSB
Set modify-read	0	0	1	1	1	0	0	0	0	0	Set modify-read mode
Reset modify-read	0	0	1	1	1	0	1	1	1	0	Release modify-read mode
Display ON/OFF	0	0	1	0	1	0	1	1	1	D	D=0: display OFF D=1: display ON
Set initial display line register	0	0	0	1	0	0	0	0	×	×	2-byte instruction to specify the initial display line to realize vertical scrolling
	0	0	×	S6	S5	S4	S3	S2	S1	S0	
Set initial COM0 Register	0	0	0	1	0	0	0	1	×	×	2-byte instruction to specify the initial COM0 to realize vertical scrolling
	0	0	×	C6	C5	C4	C3	C2	C1	C0	
Set partial display duty ratio	0	0	0	1	0	0	1	0	×	×	2-byte instruction to set partial display duty ratio
	0	0	D7	D6	D5	D4	D3	D2	D1	D0	
Set N-line inversion	0	0	0	1	0	0	1	1	×	×	2-byte instruction to set N-line inversion register
	0	0	×	×	×	N4	N3	N2	N1	N0	
Release N-line inversion	0	0	1	1	1	0	0	1	0	0	Release N-line inversion mode
Reverse display ON/OFF	0	0	1	0	1	0	0	1	1	REV	REV=0: normal display REV=1: reverse display
Entire display ON/OFF	0	0	1	0	1	0	0	1	0	EON	EON=0: normal display EON=1: entire display ON
Power control	0	0	0	0	1	0	1	VC	VR	VF	Control power circuit operation
Select DC-DC step-up	0	0	0	1	1	0	0	1	DC1	DC0	Select the step-up of the internal voltage converter
Select regulator resistor	0	0	0	0	1	0	0	R2	R1	R0	Select internal resistance ratio of the regulator resistor
Set electronic	0	0	1	0	0	0	0	0	0	1	2-byte instruction to

Supplied by:

Midas Components Limited, Electra House, 32 Southtown Road, Great Yarmouth, Norfolk, NR31 0DU

Telephone: +44 (0)1493 602602

Fax: +44 (0)1493 665111

Email: sales@midasdisplays.com

Website: www.midasdisplays.com

volume register	0	0	×	×	EV5	EV4	EV3	EV2	EV1	EV0	specify the reference voltage
Select LCD bias	0	0	0	1	0	1	0	B2	B1	B0	Select LCD bias
SHL select	0	0	1	1	0	0	SHL	×	×	×	COM bi-directional selection SHL=0: normal direction SHL=1: reverse direction
ADC select	0	0	1	0	1	0	0	0	0	ADC	SEG bi-directional selection ADC=0: normal direction ADC=1: reverse direction
Oscillator on start	0	0	1	0	1	0	1	0	1	1	Start the built-in Oscillator
Set power save mode	0	0	1	0	1	0	1	0	0	P	P=0: normal mode P=1: sleep mode
Release power save mode	0	0	1	1	1	0	0	0	0	1	Release power save mode
Reset	0	0	1	1	1	0	0	0	1	0	Initialize the internal functions
Set data direction & display data length (DDL)	×	×	1	1	1	0	1	0	0	0	2-byte instruction to specify the number of data bytes
NOP	0	0	1	1	1	0	0	0	1	1	No operation
Test Instruction	0	0	1	1	1	1	×	×	×	×	Don't use this instruction
Set FRC and PWM	0	0	1	0	0	1	0	FRC	PWM1	PWM0	FRC (1:3 FRC, 0:4 FRC) PWM1 PWM0 0 0 9PWM 0 1 9PWM 1 0 12PWM 1 1 15PWM
Set white mode and 1 st /2 nd frame, set pulse width	0	0	1	0	0	0	1	0	0	0	Set white mode and 1 st /2 nd frame
Set white mode and 3 rd /4 th frame, set pulse width	0	0	1	0	0	0	1	0	0	1	Set white mode and 3 rd /4 th frame
Set light gray mode and 1 st /2 nd frame, set pulse width	0	0	1	0	0	0	1	0	1	0	Set light gray mode and 1 st /2 nd frame
Set light gray mode and 3 rd /4 th frame, set pulse width	0	0	1	0	0	0	1	0	1	1	Set light gray mode and 3 rd /4 th frame

Set dark gray mode and 1 st /2 nd frame, set pulse width	0	0	1	0	0	0	1	1	0	0	Set dark gray mode and 1 st /2 nd frame
Set dark gray mode and 3 rd /4 th frame, set pulse width	0	0	1	0	0	0	1	1	0	1	Set dark gray mode and 3 rd /4 th frame
Set black mode and 1 st /2 nd frame, set pulse width	0	0	1	0	0	0	1	1	1	0	Set black mode and 1 st /2 nd frame
Set black mode and 3 rd /4 th frame, set pulse width	0	0	1	0	0	0	1	1	1	1	Set black mode and 3 rd /4 th frame

Supplied by:

Midas Components Limited, Electra House, 32 Southtown Road, Great Yarmouth, Norfolk, NR31 0DU

Telephone: +44 (0)1493 602602

Fax: +44 (0)1493 665111

Email: sales@midasdisplays.com

Website: www.midasdisplays.com

7.0 ABSOLUTE MAXIMUM RATINGS (Ta = 25°C, VSS = 0 V)

Parameter	Symbol	Min	Typ.	Max	Unit
Supply voltage for Logic	V _{DD}	-0.3	-	7.0	V
Supply voltage for LCD	V ₀ -V _{SS}	-0.3	-	+19.8	V
Input voltage	V _{IN}	-0.3	-	V _{DD} +0.3	V
Operating temperature	T _{OP}	-20	-	70	°C
Storage temperature	T _{ST}	-30	-	80	°C

Remarks: it is a normal characteristic that the LCD color and contrast will change (sometimes unevenness can be seen) under low temperature and high temperature environment. When the application temperature returns back to room temperature, LCD color and contrast will reverse back to its original color and contrast within 24 hours and its functionality is not affected.

8.0 ELECTRICAL CHARACTERISTICS (Ta = 25°C, VSS = 0 V, VDD=3.3V)

Parameter	Symbol	Min	Typ.	Max	Unit
Supply voltage for LCD	V _{LCD} or V _{OP}	13.05	13.25	13.45	V
Input voltage	V _{IH}	0.8V _{DD}	-	V _{DD}	V
	V _{IL}	V _{SS}	-	0.2V _{DD}	V
Logic supply current	I _{DD}	-	-	300	μA
LCM supply current	I _{LCM}	-	-	1500	μA

Remarks: Please kindly set the supply voltage for LCD, V_{LCD} within the recommended V_{op} range. For high duty ratio or grayscale display, small mismatch (even 1%) between the required supply voltage for LCD (V_{op}) with the IC driving voltage (V_{LCD}) can cause cross-talk or display dim issue. It is unlikely for LCD maker and IC maker to have such high precision (<1%) on the V_{op} and V_{LCD} respectively. Thus it is strongly recommended default-V_{LCD} fine tuning is needed at customer side to ensure best LCD visual performance. Default-V_{LCD} fine tuning can be done using software method (electronic volume setting adjustment, OTP or MTP) or hardware method (external resistor trim pot or voltage regulator).

9.0 ELECTRO-OPTICAL CHARACTERISTICS

No	Item	Symbol	Measuring Conditions	Min.	Typ.	Max.	Unit	Remark	
1	Response Time	Rise	Tr	θ = 0° φ = 0°	70°C	--	80	ms	Note (a)
					25°C	--	150		
					-20°C	--	2000		
		Fall	Tf	θ = 0° φ = 0°	70°C	--	120		
					25°C	--	200		
					-20°C	--	5000		
2	Viewing Angle (CR ≥ 2)	θ	φ = 0°	25°C	30	35	Deg	Note (b)	
				25°C	30	35			
				25°C	30	35			
				25°C	30	35			
3	Contrast Ratio	CR	-	25°C	8	20	-	Note (c)	

Supplied by:

Midas Components Limited, Electra House, 32 Southtown Road, Great Yarmouth, Norfolk, NR31 0DU

Telephone: +44 (0)1493 602602

Fax: +44 (0)1493 665111

Email: sales@midasdisplays.com

Website: www.midasdisplays.com

Note (a): Definition of Response Time

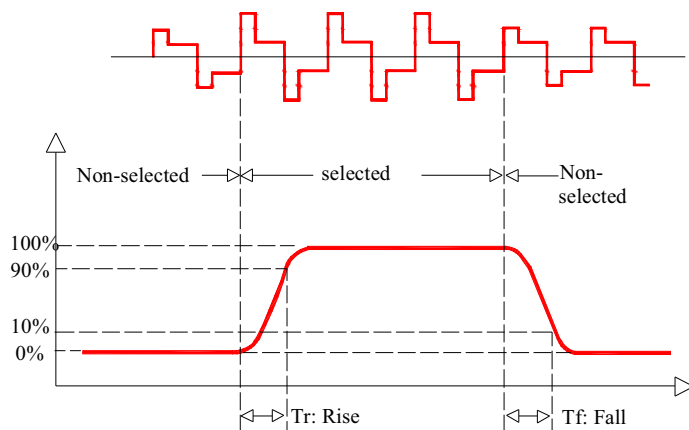

Note(b): Definition of Viewing angle

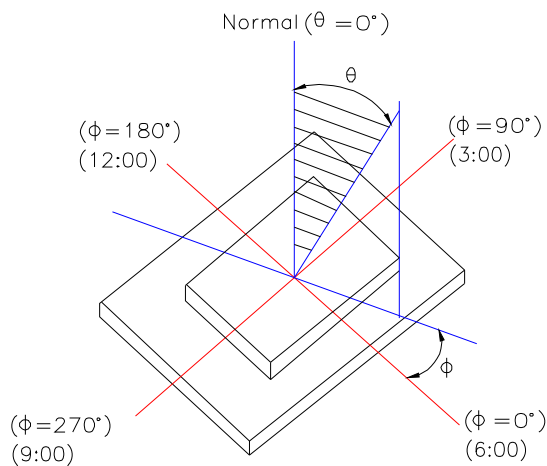

Note (c): Definition of Contrast Ratio

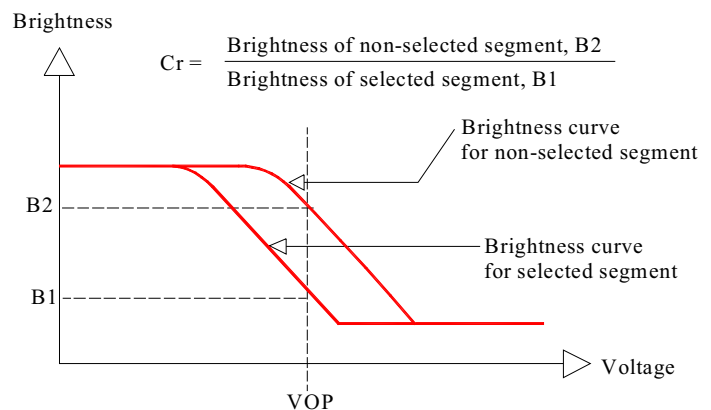

10.0 BACKLIGHT SPECIFICATION

10.1 LED Backlight Absolute Maximum Ratings ($T_a=25^\circ\text{C}$)

Item	Symbol	Conditions	Min	Max	Unit
Absolute maximum forward current	I_{f_m}	-	-	2×60	mA
Peak forward current	I_{f_p}	1 msec plus , 1/10 duty cycle	-	2×200	mA
Reverse voltage	V_r	-	-	3	V
Power dissipation	P_b	-	-	2×105	mW
Operating temperature range	T_{opr}	-	-20	70	$^\circ\text{C}$
Storage temperature range	T_{stg}	-	-30	80	$^\circ\text{C}$

Supplied by:

Midas Components Limited, Electra House, 32 Southtown Road, Great Yarmouth, Norfolk, NR31 0DU

Telephone: +44 (0)1493 602602

Fax: +44 (0)1493 665111

Email: sales@midasdisplays.com

Website: www.midasdisplays.com

10.2 LED Backlight Electrical-optical characteristics

Item	Symbol	Min.	Typ.	Max.	Unit	Conditions
Forward voltage	V _f	3.1	3.3	3.5	V	I _f =2x30mA T=25°C
Luminance	L _v	200	-	-	cd/m ²	
Chromaticity coordinates	X	0.26	-	0.30	-	
	Y	0.28	-	0.32	-	
Reverse current	I _r	-	-	20	μA	V _r = 3V
Uniformity	Δ	70%	-	-	%	Min/max*100%

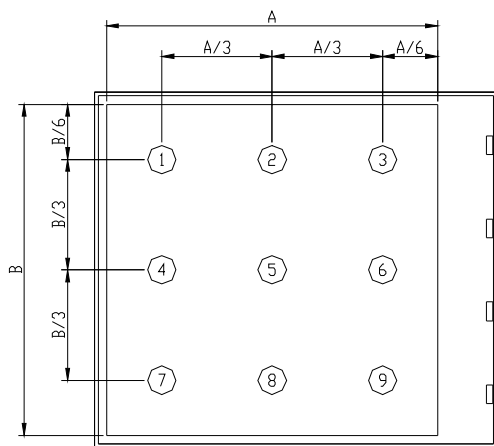

The luminance is the average value of 9 point.
The measurement instrument is BM-7 luminance Colorimeter.
The field = 1.0 ABS.

10.3 LED Backlight Circuit Diagram (LED 2*2=4 dies)

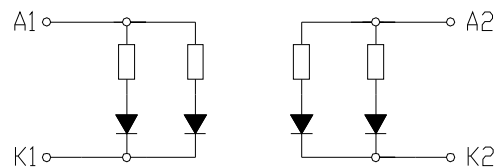

10.4 LED Electrical Characteristics

(1) A LED Forward current VS.
- Ambient Temperature

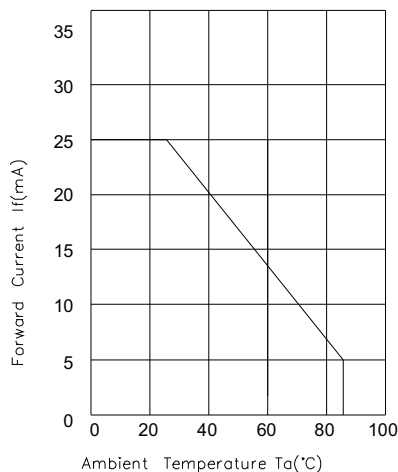

(2) A LED Forward current VS.
- Forward Voltage

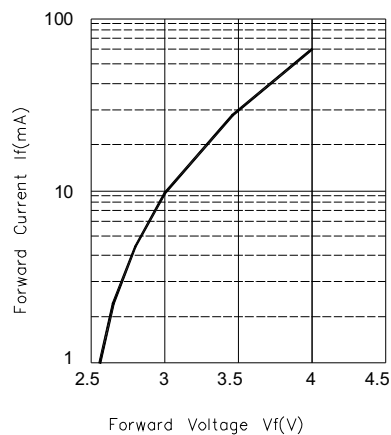

Supplied by:

Midas Components Limited, Electra House, 32 Southtown Road, Great Yarmouth, Norfolk, NR31 0DU

Telephone: +44 (0)1493 602602

Fax: +44 (0)1493 665111

Email: sales@midasdisplays.com

Website: www.midasdisplays.com

11.0 STANDARD SPECIFICATION FOR RELIABILITY

11.1 Standard specification of Reliability Test

Environmental Test				
No.	Test Item	Content of Test	Test Condition	Applicable Standard
1	Low temperature storage	Endurance test applying the low storage temperature for a long time.	-30+/-3°C for 96Hrs	----
2	High Temperature Storage	Endurance test applying the high storage temperature for a long time.	80+/-3 °C for 96Hrs	----
3	Moisture Temperature Operation	Endurance test applying the electric stress and temperature / humidity stress to the element for a long time.	40+/-3 °C, 90%RH for 240Hrs	----
4	Temperature Cycling	Endurance test applying the low and high temperature cycle.	-30°C/30min, +80°C/30min, 10 cycles	----
Mechanical Test				
5	Drop Test	Endurance test applying the drop during transportation.	Packed, 100cm free fall (6 sides, 1 corner, 3edges)	----

Remarks:

- 1) For operation test, above specification is applicable when test pattern is changing during entire operation test.
- 2) Inspections after reliability tests are performed when the display temperature resumes back to room temperature.
- 3) It is a normal characteristic that some display abnormality can be seen during reliability test. If the display abnormality can resume back to normal condition at room temperature within 24hours, there is no permanent destruction over the display. The display still possesses its functionality after reliability tests.

11.2 Failure Judgment Criteria

After the reliability tests above, test sample shall be let return to room temperature and humidity for at least 4 hours before final tests are carried out.

Criterion Item	Failure Judgment Criteria
Electrical characteristic	Electrical short and open.
Mechanical characteristic	Out of mechanical specification
Optical characteristic	Out of the Appearance Standard

12.0 QUALITY ASSURANCE

12.1 Acceptable Quality Level (AQL)

Each lot should satisfy the quality level defined as follows:

- a) Inspection method: MIL-STD-105E Level II normal one time sampling
- b) AQL level

Category	AQL	Definition
Major	0.25%	Functional defective as product
Minor	1.00%	Satisfy all functions as product but not satisfy cosmetic standard

12.2 Conditions of Inspection

The inspection should be performed under following conditions:

- a) Under 2 pieces of 30W white fluorescent lamps located 1m height from the LCD module.
- b) 30cm view distance vertically from the LCD panel.
- c) Under normal temperature 20~25°C and normal humidity 60±15%RH.
- d) LCD driving voltage at stated in the specification and within ±0.5V of the typical value at 25°C.

12.3 Cosmetic Screening Criteria

No	Defect	Judgment Criteria	Category		
1	Spots/Dust /Bubble (Round type)	Size, d (mm)	Acceptable quantity in active area	Minor	
		$d \leq 0.15$	Disregard		
		$0.15 < d \leq 0.20$	3		
		$d > 0.20$	0		
2	Dust/Scratches/ Black streak (Line type)	Width, W (mm)	Length, L (mm)	Acceptable quantity in active area	Minor
		$W \leq 0.02$	Disregard	Disregard	
		$W \leq 0.03$	$L \leq 1.0$	Disregard	
		$W \leq 0.05$	$L \leq 2.0$	3	
		$W > 0.05$	Disregard	0	
3	Allowable density	Above defects should be separated more than 5mm each other.	Minor		
4	Rainbow	Obvious uneven color (rainbow) shall not be noticeable.	Minor		
5	Display condition	Dim display on the patterns, extra pattern and short circuit are not acceptable.	Major		
6	No display or missing display	The patterns of display shall light up as required. No display or missing display are not acceptable.	Major		

Note: $d = (\text{long length} + \text{short length}) / 2$

13.0 PRECAUTIONS FOR USING LCD MODULE

13.1 Handling Precautions

- 13.1.1 The display panel is made of glass and polarizer. Do not subject it to mechanical shock by dropping or impact which may cause chipping especially on the edges.
- 13.1.2 Do not touch, push or rub the exposed polarizers with anything harder than an HB pencil lead (glass, tweezers, etc.). The polarizer covering the display surface of the LCD module is soft and easily scratched. Handle this polarizer carefully.
- 13.1.3 If the display surface becomes contaminated, breathe on the surface and gently wipe it with a soft dry cloth. If it is heavily contaminated, moisten

Supplied by:

Midas Components Limited, Electra House, 32 Southtown Road, Great Yarmouth, Norfolk, NR31 0DU

Telephone: +44 (0)1493 602602

Fax: +44 (0)1493 665111

Email: sales@midasdisplays.com

Website: www.midasdisplays.com

- cloth with Isopropyl alcohol or ethyl alcohol. Avoid using solvents like acetone (ketene), water, toluene, ethanol to clean the polarizer surface.
- 13.1.4 Please keep the temperature within specified range for use and storage. Polarization degradation, bubble generation or polarizer peel-off may occur with high temperature and high humidity.
 - 13.1.5 Do not apply excessive force to the display surface or the adjoining areas since this may cause the color tone to vary.
 - 13.1.6 Install the LCD Module by using the mounting holes. When mounting the LCD module make sure it is free of twisting, warping and distortion.
 - 13.1.7 Exercise care to minimize corrosion of the electrode. Corrosion of the electrodes is accelerated by water droplets, moisture condensation or a current flow in a high-humidity environment.
 - 13.1.8 NC terminal should be open. Do not connect anything.
 - 13.1.9 If the logic circuit power is off, do not apply the input signals.
 - 13.1.10 Avoid contacting oil and fats.
 - 13.1.11 Condensation on the surface and contact with terminals due to cold will damage, stain or dirty the polarizers. After products are tested at low temperature they must be warmed up in a container before coming is contacting with room temperature air.
 - 13.1.12 Wipe off saliva or water drops immediately, contact with water over a long period of time may cause deformation or color fading.

13.2 Electro-Static Discharge Control

- 13.2.1 Since this module uses a CMOS LSI, the same careful attention should be paid to electrostatic discharge as for an ordinary CMOS IC.
- 13.2.2 Be sure to ground the body when handling the LCD modules. Tools required for assembling, such as soldering irons, must be properly grounded.
- 13.2.3 To reduce the amount of static electricity generated, do not conduct assembling and other work under dry conditions. To reduce the generation of static electricity, be careful that the air in the work is not too dried. A relative humidity of 50%-60% is recommended.
- 13.2.4 The LCD module is coated with a film to protect the display surface. Exercise care when peeling off this protective film since static electricity may be generated.
- 13.2.5 When soldering the terminal of LCM, make certain the AC power source for the soldering iron does not leak.

13.3 Precaution for soldering to the LCM

- 13.3.1 Observe the following when soldering lead wire, connector cable and etc. to the LCD module.
 - Soldering iron temperature: 300 ~ 350°C.
 - Soldering time: ≤ 3 sec.
 - Solder: eutectic solder.Above is a recommended approach. Due to different solder composition and processing method, it is recommended that customer to study and fine tuning their soldering process parameters accordingly.
- 13.3.2 If soldering flux is used, be sure to remove any remaining flux after finishing to soldering operation. (This does not apply in the case of a non-halogen type of flux.) It is recommended that you protect the LCD surface with a cover during soldering to prevent any damage due to flux spatters.

13.4 Precautions for Operation

Supplied by:

Midas Components Limited, Electra House, 32 Southtown Road, Great Yarmouth, Norfolk, NR31 0DU

Telephone: +44 (0)1493 602602

Fax: +44 (0)1493 665111

Email: sales@midasdisplays.com

Website: www.midasdisplays.com

- 13.4.1 Viewing angle varies with the change of liquid crystal driving voltage (V_O). Adjust V_O to show the best contrast.
- 13.4.2 Driving the LCD in the voltage above the limit shortens its lifetime.
- 13.4.3 Response time is greatly delayed at temperature below the operating temperature range. However, it will recover when it returns to the specified temperature range.
- 13.4.4 If the display area is pushed hard during operation, the display will become abnormal. However, it will return to normal if it is turned off and then back on.
- 13.4.5 When turning the power on, input each signal after the positive/negative voltage becomes stable (below figure is a general illustration where typical value depends on individual product design).

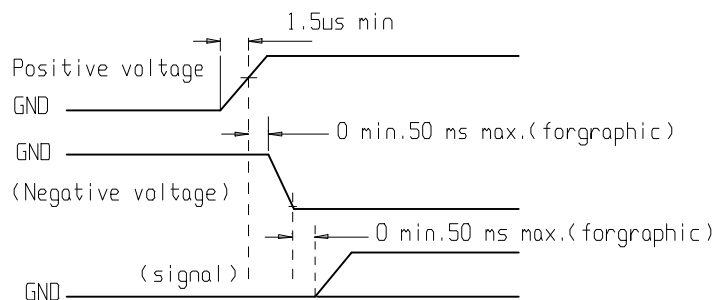

13.5 Storage

13.5.1 When storing LCDs as spares for some years, the following precautions are necessary.

- Store them in a sealed polyethylene bag. If properly sealed, there is no need for desiccant.
- Store them in a dark place. Do not expose to sunlight or fluorescent light, keep the temperature between 0°C and 35°C.

13.5.2 Environmental conditions:

- Do not leave them for more than 168hrs. at 60°C.
- Should not be left for more than 48hrs. at -20°C.

13.6 Safety

13.6.1 It is recommended to crush damaged or unnecessary LCD into pieces and wash them off with solvents such as acetone and ethanol, which should later be burned.

13.6.2 If any liquid leaks out of a damaged glass cell and comes in contact with the hands, wash off thoroughly with soap and water.

14.0 LOT NUMBERING SYSTEM

14.1 Definition of Lot Number

One lot means the delivery date and times to customer at one time.

YYMMDD XXX

(1) (2)

(1) Manufacturing date (COG bonding) (YY: Year, MM: Month, DD: Day)

(2) Serial number starts from A01,A02.....A99,B01,B02.....

14.2 Location of datecode number

Supplied by:

Midas Components Limited, Electra House, 32 Southtown Road, Great Yarmouth, Norfolk, NR31 0DU

Telephone: +44 (0)1493 602602

Fax: +44 (0)1493 665111

Email: sales@midasdisplays.com

Website: www.midasdisplays.com

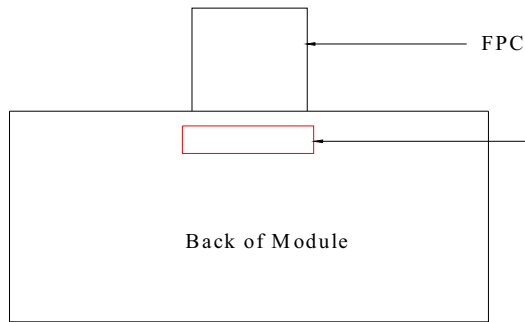

Datecode:
 This datecode is meant for traceability purpose and will not affect functionality of the display module. Thus, there is no special control on the font type, font size and orientation of the datecode as long as it is visible and readable. Please refer to outline drawing for datecode content.

15.0 PACKAGING STANDARD

Product No.	JIC-MSGF9622-09	Recycle	No
Product Name	LCD Module		
Quantity / each box	144 pcs	Box Material	Paper Carton
Outer carton Box size	46.5cm × 40.5cm × 30.5cm	Box Type	New
Quantity / inner box Quantity /outer box	12 × 6 × 2 = 144pcs	Weight	-kg

There are 12 pcs LCD per each anti-static plastic plate.
There are 6 layer plastic plates per each inner carton box.
There are 2 inner carton box per each outer carton box.

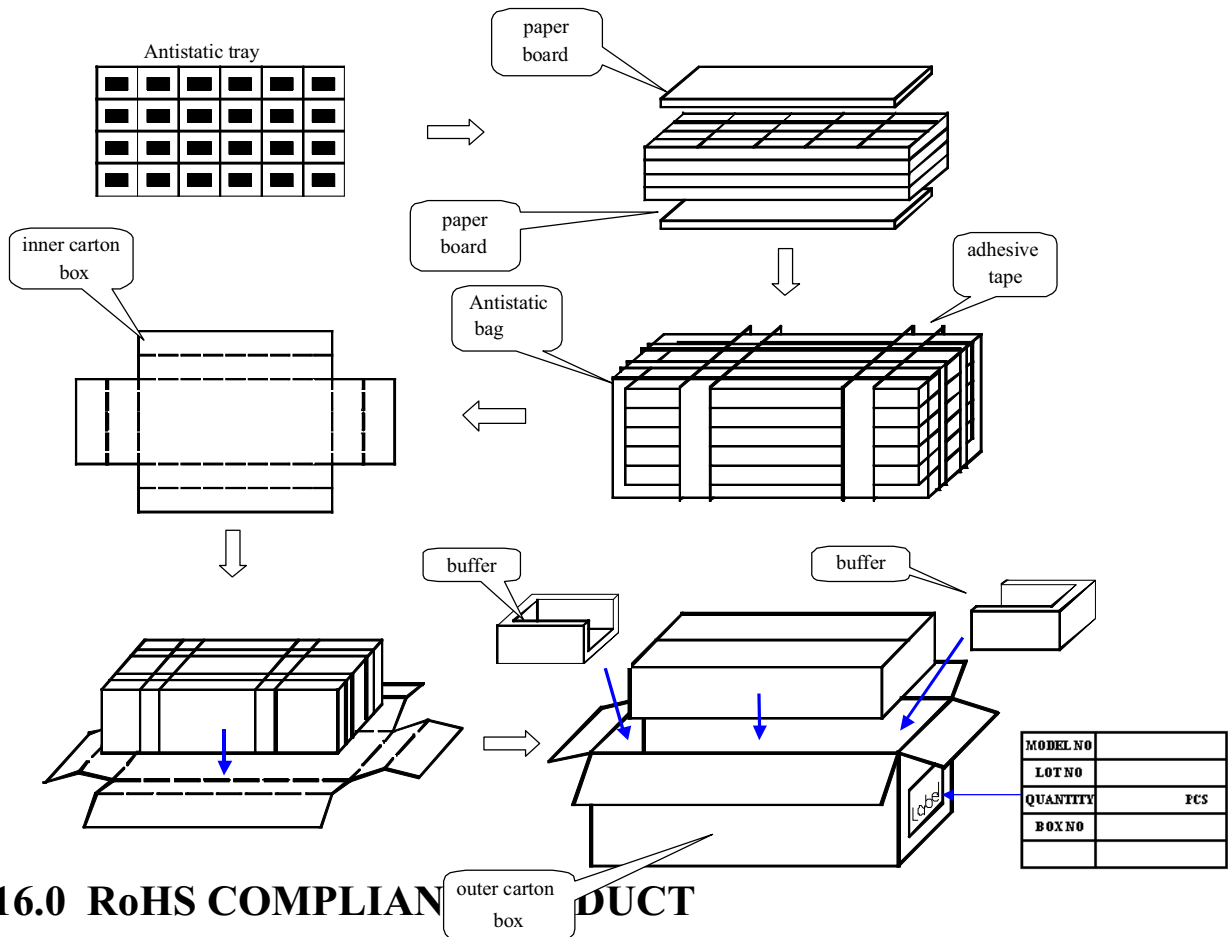

16.0 RoHS COMPLIANT PRODUCT

Standard of specific chemical substance

1. Cadmium and Cadmium Compounds	Less than 100ppm
2. Hexavalent Chromium Compounds	Less than 1000ppm
3. Lead and Lead Compounds	Less than 1000ppm
4. Mercury and Mercury Compounds	Less than 1000ppm
5. Polybrominated Biphenyls (PBBs)	Less than 1000ppm
6. Polybrominated Diphenyl ethers (PBDEs)	Less than 1000ppm

17.0 LIMITED WARRANTY

Unless agreed between JIC and customer, JIC will replace or repair any of its LCD modules, which are found to be functionally defective when inspected in accordance with JIC LCD acceptance standards (copies available upon request) for a period of one year from date of shipments. Cosmetic/visual defects must be returned to JIC within 90 days of shipment. Confirmation of such date shall be based on freight documents. The warranty liability of JIC limited to repair and/or replacement on the terms set forth above. JIC will not be responsible for any subsequent or consequential events.

18.0 MANUFACTURER CONTACT:**18.1 Manufacturer Name:****JETUP ELECTRONIC (SHENZHEN) COMPANY LIMITED**

Factory Address:

Sanyidui Industrial Zone, Zhoushi Road Jiuwei Community,

Xixiang Street, Bao'an District, Shen Zhen, Guangdong,

Postal Code 518102, People's Republic Of China.

Telephone No : 86-755-27827222

Fax No : 86-755-27825120

Supplied by:

Midas Components Limited, Electra House, 32 Southtown Road, Great Yarmouth, Norfolk, NR31 0DU

Telephone: +44 (0)1493 602602**Fax:** +44 (0)1493 665111Email: sales@midasdisplays.comWebsite: www.midasdisplays.com