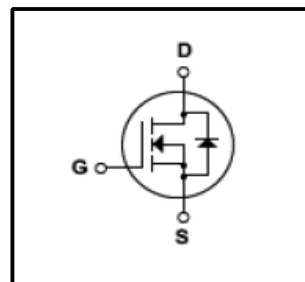
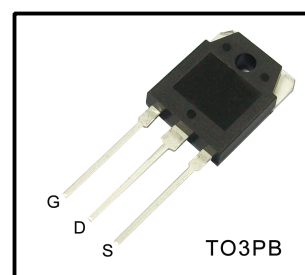

Silicon N-Channel MOSFET
Features

- 24A,500V, $R_{DS(on)}$ (Max0.19 Ω)@ $V_{GS}=10V$
- Ultra-low Gate charge(Typical 90nC)
- Fast Switching Capability
- 100%Avalanche Tested
- Maximum Junction Temperature Range(150 $^{\circ}C$)

General Description

This N-Channel enhancement mode power field effect transistors are produced using Winsemi's proprietary, planar stripe ,DMOS technology. This advanced technology has been especially tailored to minimize on-state resistance , provide superior switching performance, and withstand high energy pulse in the avalanche and commutation mode. These devices are well suited for high efficiency switch mode power supplies.

Absolute Maximum Ratings

Symbol	Parameter	Value	Units
V_{DSS}	Drain Source Voltage	500	V
I_D	Continuous Drain Current(@ $T_c=25^{\circ}C$)	24	A
	Continuous Drain Current(@ $T_c=100^{\circ}C$)	15.2	A
I_{DM}	Drain Current Pulsed (Note1)	96	A
V_{GS}	Gate to Source Voltage	± 30	V
E_{AS}	Single Pulsed Avalanche Energy (Note2)	1100	mJ
E_{AR}	Repetitive Avalanche Energy (Note1)	29	mJ
dv/dt	Peak Diode Recovery dv/dt (Note3)	4.5	V/ ns
P_D	Total Power Dissipation(@ $T_c=25^{\circ}C$)	271	W
	Derating Factor above 25 $^{\circ}C$	2.22	W/ $^{\circ}C$
T_J	Junction Temperature	150	$^{\circ}C$
T_{stg}	Storage Temperature	-55~150	$^{\circ}C$
T_L	Channel Temperature	300	$^{\circ}C$

Thermal Characteristics

Symbol	Parameter	Value			Units
		Min	Typ	Max	
R_{QJC}	Thermal Resistance , Junction -to -Case	-	-	0.46	$^{\circ}C/W$
R_{QJA}	Thermal Resistance , Junction-to -Ambient	-	-	40	$^{\circ}C/W$

Electrical Characteristics(Tc=25°C)

Characteristics	Symbol	Test Condition	Min	Type	Max	Unit	
Gate leakage current	I _{GSS}	V _{GS} =±25V, V _{DS} =0V	-	-	±100	nA	
Gate-source breakdown voltage	V _{(BR)GSS}	I _G =±10 μA, V _{DS} =0V	±30	-	-	V	
Drain cut -off current	I _{DSS}	V _{DS} =500V, V _{GS} =0V	-	-	1	μA	
		V _{DS} =400V, Tc=125 °C			10		
Drain -source breakdown voltage	V _{(BR)DSS}	I _D =10 mA, V _{GS} =0V	500	-	-	V	
Breakdown voltage Temperature coefficient	$\Delta BV_{DSS} / \Delta T_J$	I _D =250μA, Referenced to 25 °C	-	0.53	-	V/°C	
Gate threshold voltage	V _{GS(th)}	V _{DS} =10V, I _D =1mA	3.0	-	5.0	V	
Drain -source ON resistance	R _{DS(ON)}	V _{GS} =10V, I _D =9A	-	0.16	0.19	Ω	
Forward Transconductance	g _{fs}	V _{DS} =40V, I _D =9A	-	22	-	S	
Input capacitance	C _{iss}	V _{DS} =25V,	-	3500	4500	pF	
Reverse transfer capacitance	C _{rss}	V _{GS} =0V,	-	55	70		
Output capacitance	C _{oss}	f=1MHz	-	520	670		
Switching time	Rise time	tr	V _{DD} =250V, I _D =18A R _G =25Ω (Note4,5)	-	250	500	ns
	Turn-on time	ton		-	80	170	
	Fall time	tf		-	155	320	
	Turn-off time	toff		-	200	400	
Total gate charge(gate-source plus gate-drain)	Qg	V _{DD} =400V, V _{GS} =10V, I _D =18A (Note4,5)	-	90	120	nC	
Gate-source charge	Qgs		-	23	-		
Gate-drain("miller") Charge	Qgd		-	44	-		

Source-Drain Ratings and Characteristics(Ta=25°C)

Characteristics	Symbol	Test Condition	Min	Type	Max	Unit
Continuous drain reverse current	I _{DR}	-	-	-	24	A
Pulse drain reverse current	I _{DRP}	-	-	-	96	A
Forward voltage(diode)	V _{DSF}	I _{DR} =24A, V _{GS} =0V	-	-	1.4	V
Reverse recovery time	t _{rr}	I _{DR} =24A, V _{GS} =0V,	-	400	-	ns
Reverse recovery charge	Q _{rr}	dI _{DR} / dt =100 A / μs	-	4.3	-	μC

Note 1.Repeativity rating :pulse width limited by junction temperature

2.L=3.4mH I_{AS}=24A, V_{DD}=50V, R_G=25Ω, Starting T_J=25°C

3.I_{SD}≤24A, di/dt≤200A/us, V_{DD}<BV_{DSS}, STARTING T_J=25°C

4.Pulse Test:Pulse Width≤300us, Duty Cycle≤2%

5. Essentially independent of operating temperature.

This transistor is an electrostatic sensitive device

Please handle with caution

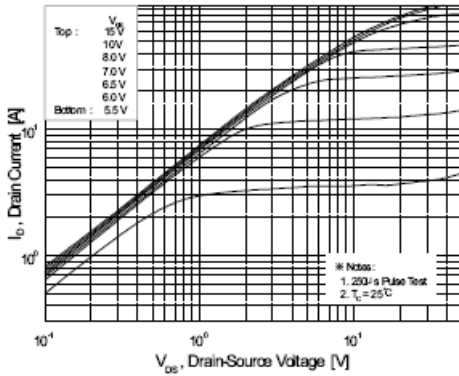

Fig.1 On State Characteristics

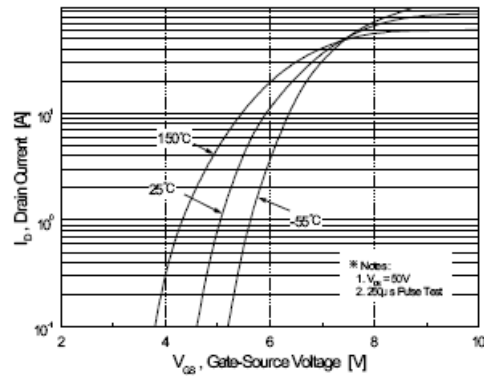

Fig.2 Transfer Current Characteristics

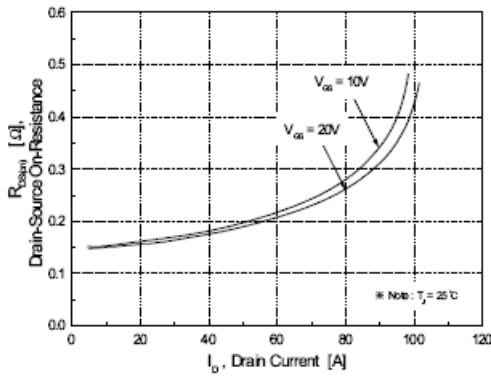

Fig.3 On-Resistance Variation vs Drain Current and gate voltage

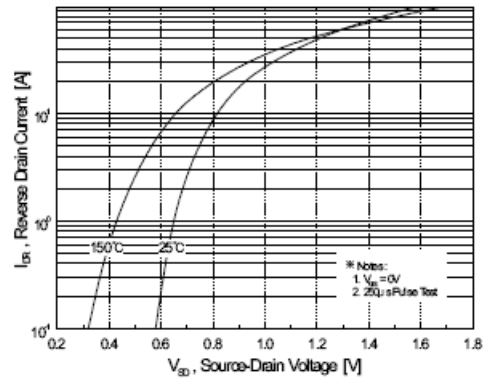

Fig.4 Body Diode Forward Voltage Variation with Source Current and Temperature

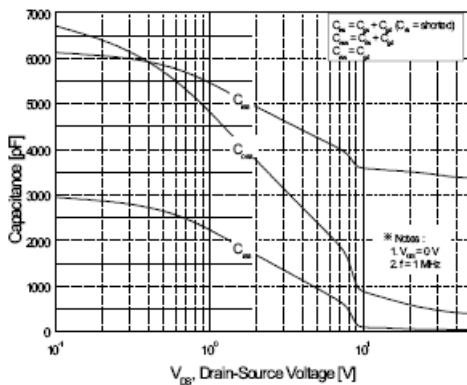

Fig.5 Capacitance Characteristics

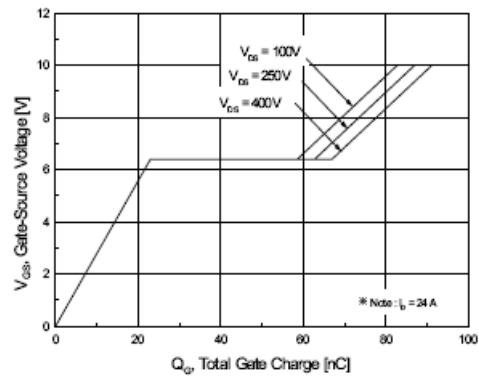

Fig.6 Gate Charge Characteristics

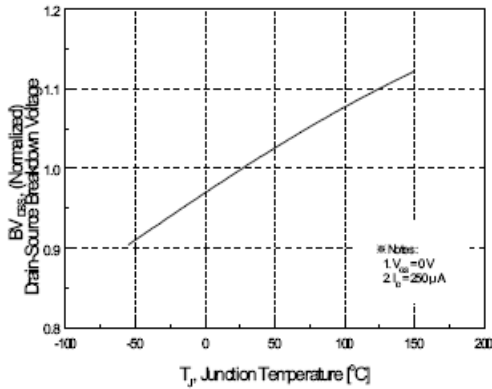

Fig.7 Breakdown Voltage Variation

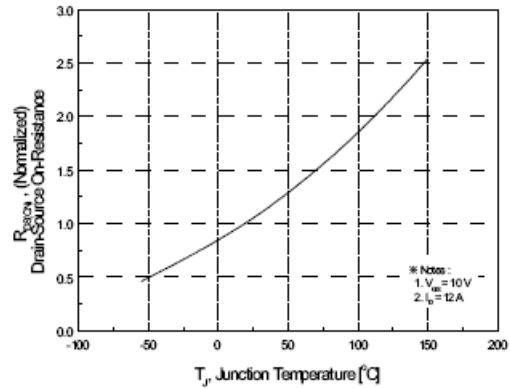

Fig.8 On-Resistance Variation vs. Temperature

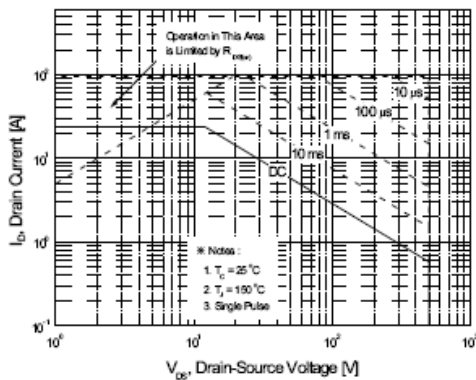

Fig.9 Maximum Safe Operation Area

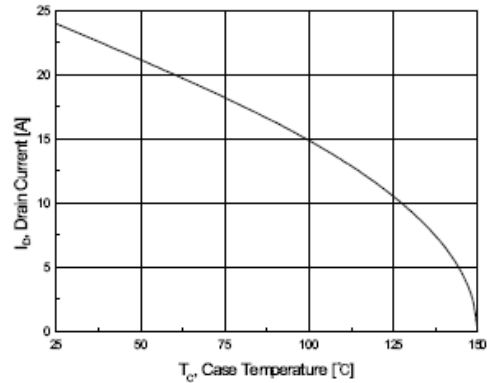

Fig.10 Maximum Drain Current vs Case Temperature

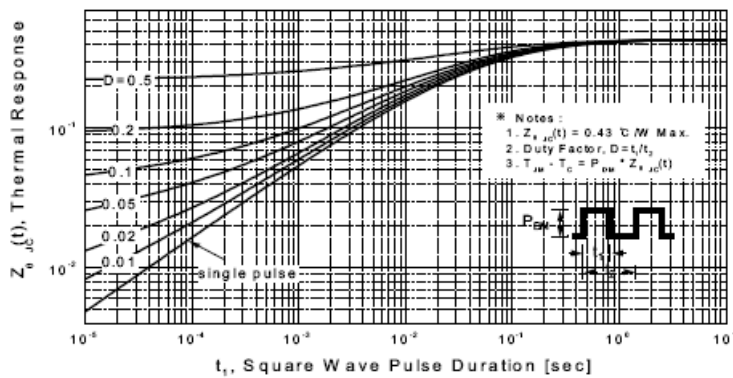

Fig.11 Transient Thermal Response Curve

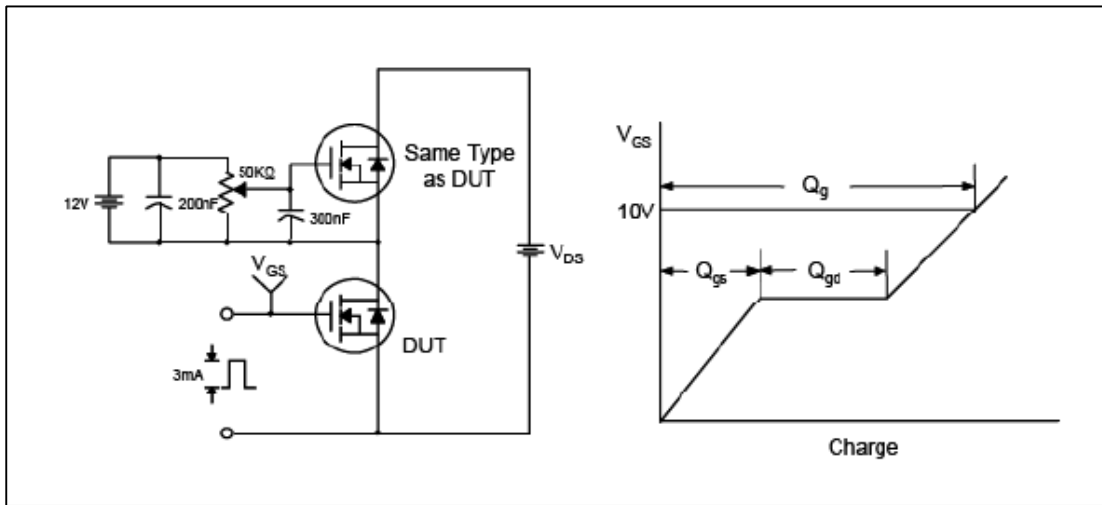

Fig.12 Gate Test Circuit & Waveform

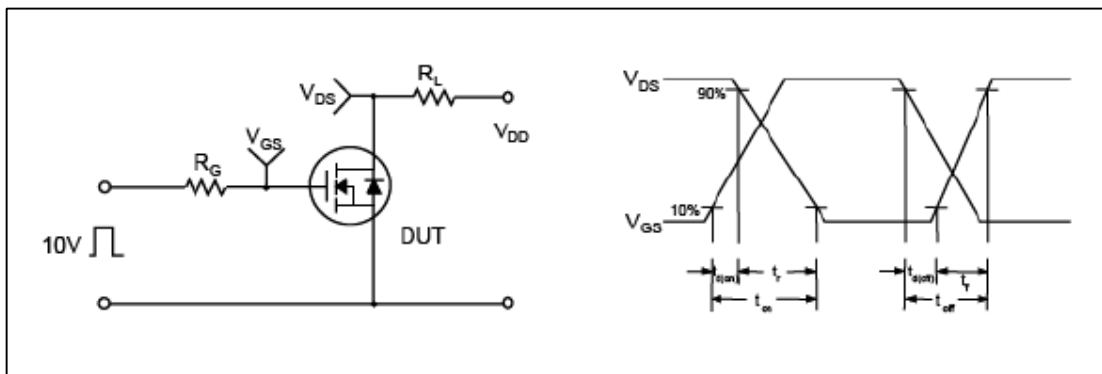

Fig.13 Resistive Switching Test Circuit & Waveform

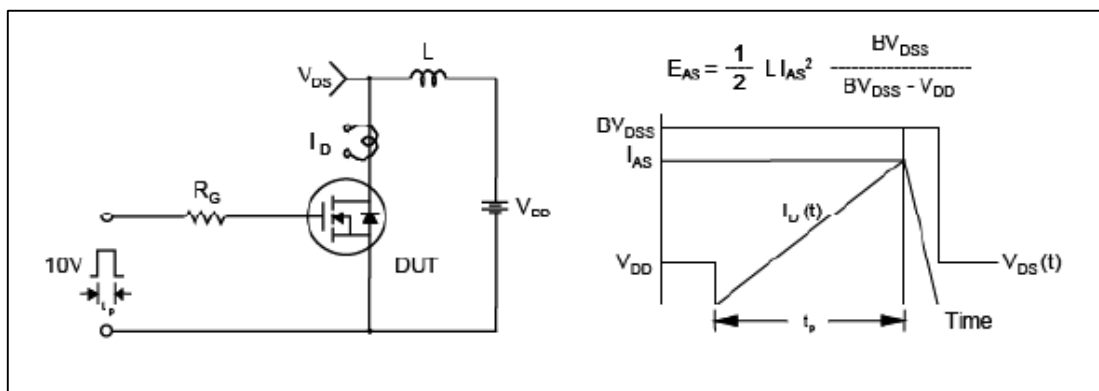

Fig.14 Unclamped Inductive Switching Test Circuit & Waveform

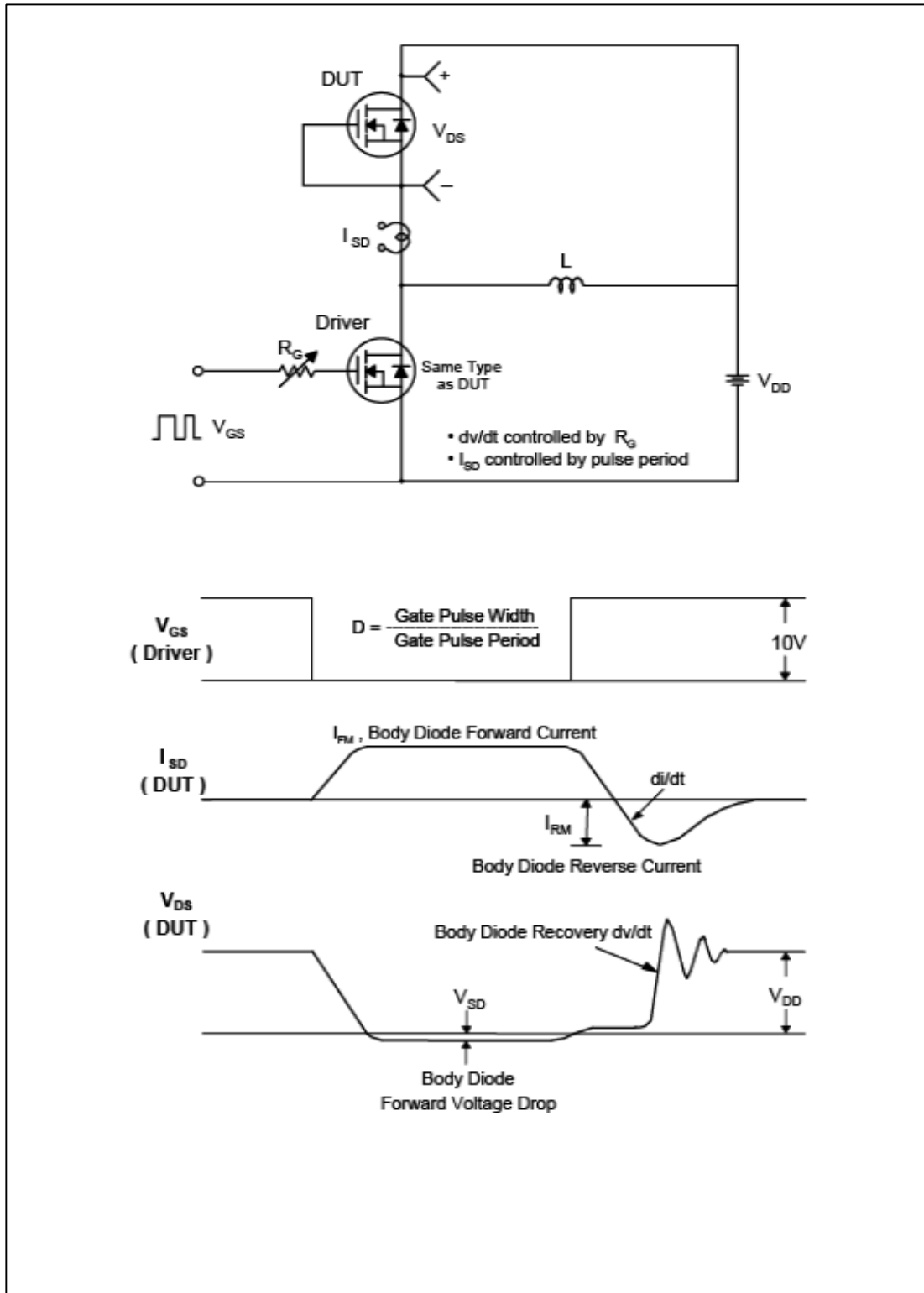

Fig.15 Peak Diode Recovery dv/dt Test Circuit & Waveform

TO-3PB Package Dimension

