



SK32BF THRU SK320BF

SURFACE MOUNT SCHOTTKY BARRIER RECTIFIER

Reverse Voltage - 20 to 200 Volts Forward Current - 3.0 Ampere

SMBF

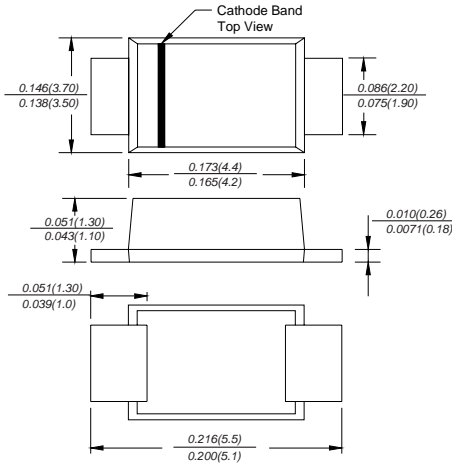

FEATURES

- ◆ Metal silicon junction, majority carrier conduction
- ◆ For surface mounted applications
- ◆ Low power loss, high efficiency
- ◆ High forward surge current capability
- ◆ For use in low voltage, high frequency inverters, free wheeling, and polarity protection applications

MECHANICAL DATA

Case: JEDEC SMBF molded plastic body
Terminals: leads solderable per MIL-STD-750, Method 2026
Mounting Position: Any
Weight: 57mg/0.002oz

MAXIMUM RATINGS AND ELECTRICAL CHARACTERISTICS

Ratings at 25°C ambient temperature unless otherwise specified.
 Single phase half-wave 60Hz, resistive or inductive load, for capacitive load current derate by 20%.

| MDD Catalog Number | SYMBOLS | SK32BF | SK34BF | SK36BF | SK38BF | SK310BF | SK315BF | SK320BF | UNITS |
|---|-----------------|-------------|--------|--------|------------|---------|---------|---------|-------|
| Marking code | | K32B | K34B | K36B | K38B | K310B | K315B | K320B | |
| Maximum repetitive peak reverse voltage | V_{RRM} | 20 | 40 | 60 | 80 | 100 | 150 | 200 | VOLTS |
| Maximum RMS voltage | V_{RMS} | 14 | 28 | 42 | 56 | 70 | 105 | 140 | VOLTS |
| Maximum DC blocking voltage | V_{DC} | 20 | 40 | 60 | 80 | 100 | 150 | 200 | VOLTS |
| Maximum average forward rectified current at TL (see fig.1) | $I_{(AV)}$ | 3.0 | | | | | | | Amp |
| Peak forward surge current 8.3ms single half sine-wave superimposed on rated load (JEDEC Method) | I_{FSM} | 80.0 | | | 70.0 | | | | Amps |
| Maximum instantaneous forward voltage at 3.0A | V_F | 0.55 | 0.70 | 0.85 | | 0.95 | | | Volts |
| Maximum DC reverse current at rated DC blocking voltage | I_R | 0.5 5.0 | | | 0.3 3.0 | | | | mA |
| Typical junction capacitance (NOTE 1) | C_J | 450 | | | 400 | | | | pF |
| Typical thermal resistance (NOTE 2) | $R_{\theta JA}$ | 50.0 | | | | | | | °C/W |
| Operating junction temperature range | T_J | -50 to +125 | | | | | | | °C |
| Storage temperature range | T_{STG} | -50 to +150 | | | | | | | °C |

Note: 1. Measured at 1MHz and applied reverse voltage of 4.0V D.C.
 2. P.C.B. mounted with 0.2x0.2" (5.0x5.0mm) copper pad areas



RATINGS AND CHARACTERISTIC CURVES SK32BF THRU SK320BF

Fig.1 Forward Current Derating Curve

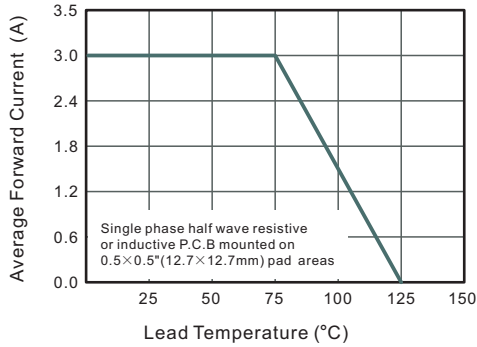

Fig.2 Typical Reverse Characteristics

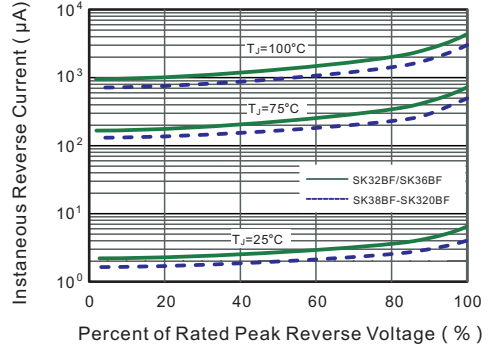

Fig.3 Typical Forward Characteristic

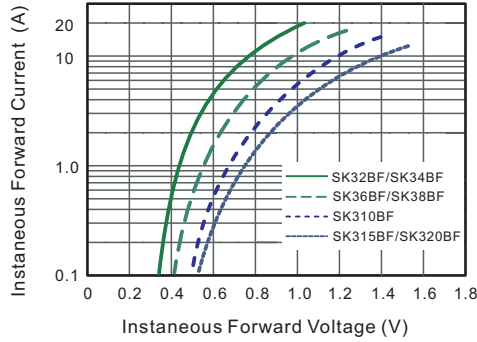

Fig.4 Typical Junction Capacitance

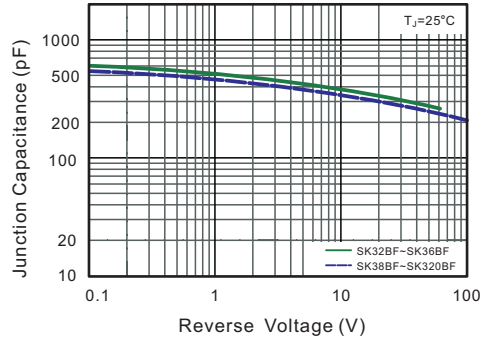

Fig.5 Maximum Non-Repetitive Peak Forward Surge Current

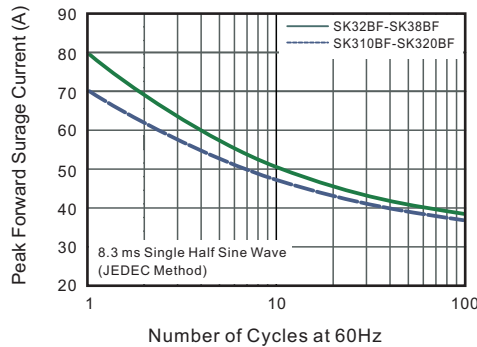
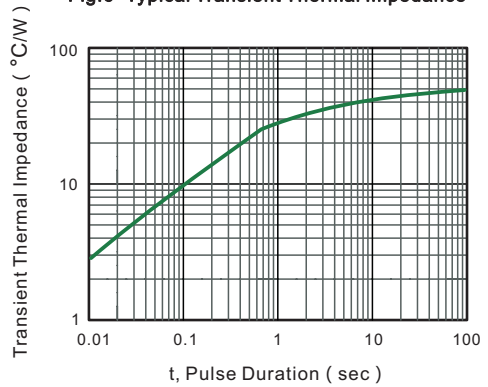

Fig.6- Typical Transient Thermal Impedance



The cruve graph is for reference only, can't be the basis for judgment(曲线图仅供参考!)

