

Single-phase Current Relay K8AB-AS

CSM_K8AB-AS_DS_E_5_1

Ideal for current monitoring for industrial facilities and equipment.

- Monitor for overcurrents or undercurrents.
- Manual resetting and automatically resetting supported by one Relay.
- Startup lock and operating time can be set separately.
- One SPDT output relay, 6 A at 250 VAC (resistive load).
- Output relay can be switched between normally open and normally closed.
- Process control signal (4 to 20 mA) and commercial CT input (0 to 1 A or 0 to 5 A) supported.
- Output status can be monitored using LED indicator.
- Inputs are isolated from the power supply.

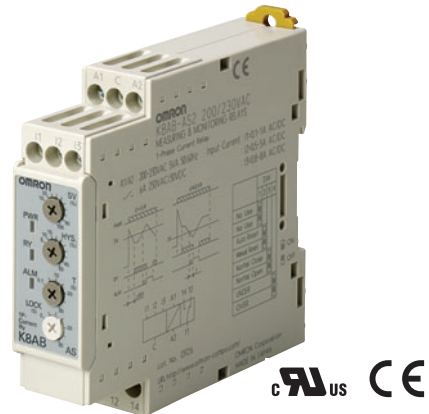

Refer to *Safety Precautions for the K8AB Series*. Refer to page 9 for the Q&A section.

Model Number Structure

■ Model Number Legend

K8AB-□□□□

1 2 3 4

1. Basic Model

K8AB: Measuring and Monitoring Relays

2. Functions

AS: Single-phase Current Relay (One-sided operation)

3. Measuring Current

- 1: 2 to 20 mA AC/DC, 10 to 100 mA AC/DC, 50 to 500 mA AC/DC
- 2: 0.1 to 1 A AC/DC, 0.5 to 5 A AC/DC, 0.8 to 8 A AC/DC
- 3: 10 to 100 A AC, 20 to 200 A AC (See note.)

Note: The K8AB-AS3 is specially designed to be used in combination with the OMRON K8AC-CT200L Current Transformer (CT). (Direct input is not possible.)

4. Supply Voltage

- 24 VAC/DC: 24 VAC/DC
100-115 VAC: 100 to 115 VAC
200-230 VAC: 200 to 230 VAC

Ordering Information

List of Models

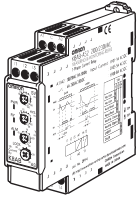
Single-phase Current Relay	Measuring current	Supply voltage	Model
	2 to 20 mA AC/DC, 10 to 100 mA AC/DC, 50 to 500 mA AC/DC	24 VAC/DC	K8AB-AS1 24 VAC/DC
		100-115 VAC	K8AB-AS1 100-115 VAC
		200-230 VAC	K8AB-AS1 200-230 VAC
	0.1 to 1 A AC/DC, 0.5 to 5 A AC/DC, 0.8 to 8 A AC/DC	24 VAC/DC	K8AB-AS2 24 VAC/DC
		100-115 VAC	K8AB-AS2 100-115 VAC
		200-230 VAC	K8AB-AS2 200-230 VAC
	10 to 100 A AC, 20 to 200 A AC (See note.)	24 VAC/DC	K8AB-AS3 24 VAC/DC
		100-115 VAC	K8AB-AS3 100-115 VAC
		200-230 VAC	K8AB-AS3 200-230 VAC

Note: The K8AB-AS3 is designed to be used in combination with an OMRON K8AC-CT200L Current Transformer (CT). (Direct input is not possible.)

Accessory (Order Separately)

OMRON CT

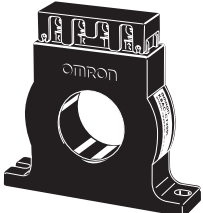
Current Transformer	Input range	Applicable Relay	Model
	10 to 100 A AC, 20 to 200 A AC	K8AB-AS3	K8AC-CT200L

Other CTs

CT current on secondary side	Applicable Relay
0 to 1 A AC, 0 to 5 A AC	K8AB-AS2

Ratings and Specifications

Input Range

Model	Range*	Connection terminal	Measuring current	Input impedance	Overload capacity
K8AB-AS1	0 to 20 mA AC/DC	I1-COM	2 to 20 mA AC/DC, 10 to 100 mA AC/DC, 50 to 500 mA AC/DC	Approx. 5 Ω	Continuous input: 120% of maximum input 1 s max.: 150% of maximum input
	0 to 100 mA AC/DC	I2-COM		Approx. 1 Ω	
	0 to 500 mA AC/DC	I3-COM		Approx. 0.2 Ω	
K8AB-AS2	0 to 1 A AC/DC	I1-COM	0.1 to 1 A AC/DC, 0.5 to 5 A AC/DC, 0.8 to 8 A AC/DC	Approx. 0.12 Ω (Load: 0.5 VA)	
	0 to 5 A AC/DC	I2-COM		Approx. 0.02 Ω (Load: 1.5 VA)	
	0 to 8 A AC/DC	I3-COM		Approx. 0.02 Ω (Load: 3 VA)	
K8AB-AS3	0 to 100 A AC	I2-COM	10 to 100 A AC, 20 to 200 A AC (See note.)	Using OMRON CT	Continuous input: 120% of maximum input 30 s max.: 200% of maximum input 1 s max.: 600% of maximum input
	0 to 200 A AC	I3-COM		Using OMRON CT	

Note: The K8AB-AS3 is designed to be used in combination with an OMRON K8AC-CT200L Current Transformer (CT). (Direct input is not possible.)

* The range is selected using connected terminals.

■ Ratings

Power supply voltage	Isolated power supply	24 VDC, 24 VAC, 100 to 115 VAC, 200 to 230 VAC
Power consumption		24 VDC: 1 W max. 24 VAC: 4 VA max. 100 to 115 VAC: 4 VA max. 200 to 230 VAC: 5 VA max.
Operating value setting range (SV)		10% to 100% of maximum measuring current K8AB-AS1: 2 to 20 mA AC/DC 10 to 100 mA AC/DC 50 to 500 mA AC/DC K8AB-AS2: 0.1 to 1 A AC/DC 0.5 to 5 A AC/DC 0.8 to 8 A AC/DC K8AB-AS3: When used together with a K8AC-CT200L Current Transformer 10 to 100 A AC 20 to 200 A AC
Operating value		100% operation at set value
Reset value setting range (HYS.)		5% to 50% of operating value
Reset method		Manual reset/automatic reset (switchable) Note: Manual reset: Turn OFF power supply for 1 s or longer.
Operating time setting range (T)		0.1 to 30 s
Startup lock time setting range (LOCK) Note: Enabled only for overcurrent operation.		0 to 30 s (The startup lock timer starts when the input has reached approximately 30% or more of the set value.) Note: Enabled only for overcurrent operation.
Indicators		Power (PWR): Green, Relay output (RY): Yellow, Alarm outputs (ALM): Red
Input impedance		Refer to "Input Range" on previous page.
Output relays		One SPDT relay (NO/NC switched using DIP switch.)
Output relay ratings		Rated load Resistive load 6 A at 250 VAC ($\cos\phi = 1$) 6 A at 30 VDC ($L/R = 0$ ms) Inductive load 1 A at 250 VAC ($\cos\phi = 0.4$) 1 A at 30 VDC ($L/R = 7$ ms) Maximum contact voltage: 250 VAC Maximum contact current: 6 A AC Maximum switching capacity: 1,500 VA Minimum load: 10 mA at 5 VDC Mechanical life: 10,000,000 operations Electrical life: Make: 50,000 times, Break: 30,000 times
Ambient operating temperature		-20 to 60°C (with no condensation or icing)
Storage temperature		-40 to 70°C (with no condensation or icing)
Ambient operating humidity		25% to 85% (with no condensation)
Storage humidity		25% to 85% (with no condensation)
Altitude		2,000 m max.
Terminal screw tightening torque		0.49 N·m
Terminal wiring method		Recommended wire Solid wire: 2.5 mm ² Twisted wires: AWG16, AWG18 Note: 1. Ferrules with insulating sleeves must be used with twisted wires. 2. Two wires can be twisted together. Recommended ferrules Al 1,5-8BK (for AWG16) manufactured by Phoenix Contact Al 1-8RD (for AWG18) manufactured by Phoenix Contact Al 0,75-8GY (for AWG18) manufactured by Phoenix Contact
Case color		Munsell 5Y8/1
Case material		PBT/ABS resin (self-extinguishing resin) UL94-V0
Weight		Approx. 130 g
Mounting		Mounted to DIN Track or via M4 screws (tightening torque: 1.2 N·m)
Dimensions		22.5 (W) × 90 (H) × 100 (D) mm

■ Specifications

Allowable power supply voltage range		85% to 110% of power supply voltage
Allowable power supply frequency range		50/60 Hz \pm 5 Hz
Input frequency range		K8AB-AS1 and K8AB-AS2: DC input or AC input (45 to 65 Hz) K8AB-AS3: AC input (45 to 65 Hz)
Overload capacity		K8AB-AS1 and K8AB-AS2: Continuous input: 120% of maximum input, 1 s max.: 150% of maximum input. K8AB-AS3: Continuous input: 120% of maximum input, 30 s max.: 200% of maximum input, 1 s max.: 600% of maximum input Note: Overload capacity of primary side of CT.
Setting error	Operating value	Set value \pm 10% full scale
	Reset value	
	Operating time	
	Startup lock time	
Repeat error	Operating value	Operating value \pm 2% Error calculation: Error = ((Maximum operating value – Minimum operating value (over 10 operations))/2)/Average value \times 100%
	Reset value	Reset value \pm 2% Error calculation: Error = ((Maximum reset value – Minimum reset value (over 10 resets))/2)/Average value \times 100%
	Operating time	Operating time repeat error: \pm 50 ms Overcurrent: Measured when input suddenly changes from 0% to 120% of setting. Undercurrent: Measured when input suddenly changes from 120% to 0% of setting.
	Startup lock time	Startup lock time repeat error: \pm 50 ms (measured at sudden change from 0% to 120% of setting)
Temperature influence		Operating value Drift based on measured value at standard temperature: –20°C to standard temperature: \pm 1,000 ppm/°C max. Standard temperature to 60°C: \pm 1,000 ppm/°C max. (Humidity: 25% to 80%) Operating time Fluctuation based on measured value at standard temperature: –20°C to standard temperature: \pm 10% max. Standard temperature to 60°C: \pm 10% max. (Humidity: 25% to 80%)
Humidity influence		Operating value Based on ambient humidity of 65% 25% to 80%: \pm 5% max. Operating time Based on ambient room humidity 25% to 80%: \pm 10% max.
Influence of power supply voltage		Operating value: \pm 5% max. Operating time: \pm 10% max. Note: The error in the operating value and operating time under standard conditions.
Influence of power supply frequency		Operating value: \pm 5% max. (at 45 to 65 Hz) Operating time: \pm 10% max. (at 45 to 65 Hz) Note: The error in the operating value and operating time under standard conditions.
Influence of input frequency		Operating value (45 to 65 Hz) K8AB-AS1 and K8AB-AS2: \pm 5% max. K8AB-AS3: \pm 10% max. Operating time (45 to 65 Hz) \pm 10% max. Note: The error in the operating value and operating time under standard conditions.
Applicable standards	Conforming standards	EN60255-5 and EN60255-6 Installation environment (Pollution Degree 2, Overvoltage Category III)
	EMC	EN61326
Insulation resistance		20 M Ω min. Between external terminals and case Between power supply terminals and input terminals (excluding models with DC power supply) Between power supply terminals and output terminals Between input terminals and output terminals
Dielectric strength		2,000 VAC for one minute Between external terminals and case Between power supply terminals and input terminals (excluding models with DC power supply) Between power supply terminals and output terminals Between input terminals and output terminals
Noise immunity		1,500 V power supply terminal common/normal mode Square-wave noise of \pm 1 μ s/100 ns pulse width with 1-ns rise time
Vibration resistance		Frequency 10 to 55 Hz, 0.35-mm single amplitude, acceleration 50 m/s ² 10 sweeps of 5 min each in X, Y, and Z directions
Shock resistance		100 m/s ² , 3 times each in 6 directions along three axes (up/down, left/right, forward/backward)
Degree of protection		Terminal section: Finger protection

Connections

■ Wiring Diagram

Overcurrent Operation Diagram (Output Relay Drive Method: Normally Open)

DIP switch setting: SW3 OFF.

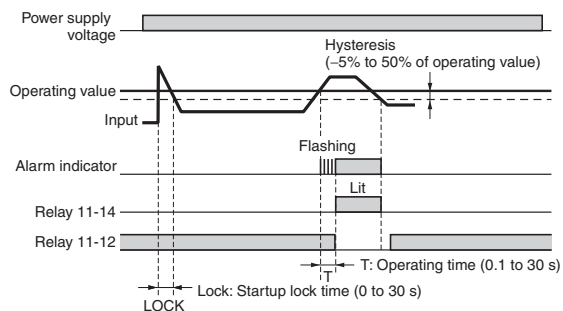

Undercurrent Operation Diagram (Output Relay Drive Method: Normally Closed)

DIP switch setting: SW3 ON.

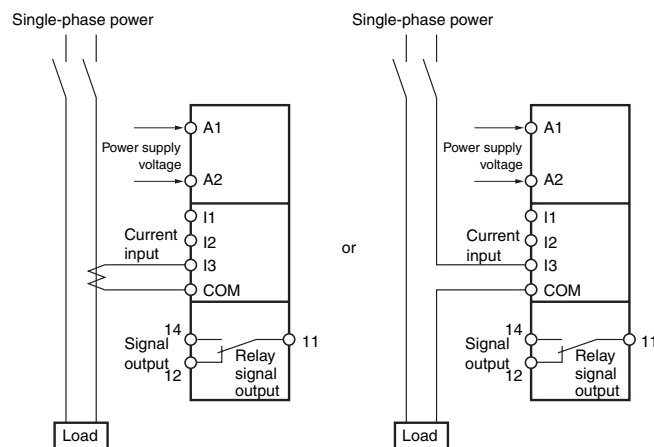
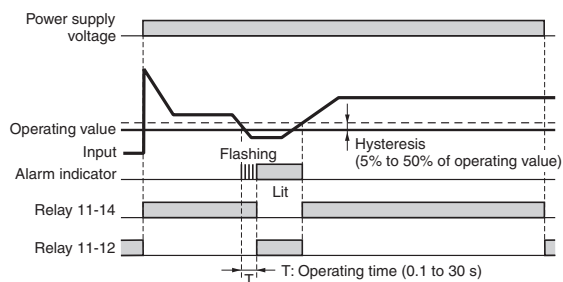

- Note:**
1. The K8AB-AS3 is designed to be used in combination with the OMRON K8AC-CT200L Current Transformer (CT).
 2. There is no polarity when a DC current input is used.
 3. Refer to the "Setting Ranges and Wiring Connections" as the explanation of current input I1, I2, and I3 terminal.

Nomenclature

Front

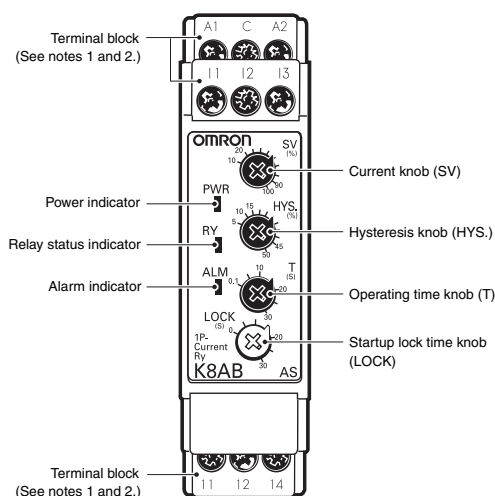

Indicators

Item	Meaning
Power indicator (PWR: Green)	Lit when power is being supplied.
Relay status indicator (RY: Yellow)	Lit when relay is operating.
Alarm indicator (ALM: Red)	Lit when there is an overcurrent or undercurrent. The indicator flashes to indicate the error status after the input has exceeded the threshold value while the operating time is being clocked.

Setting Knobs

Item	Usage
Current knob (SV)	Used to set the current to 10% to 100% of maximum measuring current.
Hysteresis knob (HYS.)	Used to set the rest value to 5% to 50% of the operating value.
Operating time knob (T)	Used to set the operating time to 0.1 to 30 s.
Startup lock time knob (LOCK)	Used to set the startup lock time to 0 to 30 s.

Note: 1. Use either a solid wire of 2.5 mm² maximum or a ferrule with insulating sleeve for the terminal connection. The length of the exposed current-carrying part inserted into the terminal must be 8 mm or less to maintain dielectric strength after connection.

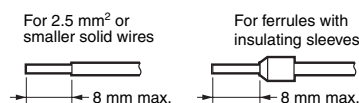

Recommended ferrules

- Phoenix Contact
- AI 1,5-8BK (for AWG16)
 - AI 1-8RD (for AWG18)
 - AI 0,75-8GY (for AWG18)

- 2.** Tightening torque
Recommended: 0.49 N·m
Maximum: 0.54 N·m

■ Operation and Setting Methods

Setting Ranges and Wiring Connections

Model	Measuring current	Wiring connection
K8AB-AS1	2 to 20 mA AC/DC	I1-COM
	10 to 100 mA AC/DC	I2-COM
	50 to 500 mA AC/DC	I3-COM
K8AB-AS2	0.1 to 1 A AC/DC	I1-COM
	0.5 to 5 A AC/DC	I2-COM
	0.8 to 8 A AC/DC	I3-COM
K8AB-AS3	10 to 100 A AC (See note 2.)	I2-COM
	20 to 200 A AC (See note 2.)	I3-COM

- Note:**
1. The DC input terminals have no polarity.
 2. The K8AB-AS3 is designed to be used in combination with the OMRON K8AC-CT200L Current Transformer (CT). (Direct input is not possible.)

Connections

1. Input

Connect the input between the I1-COM, I2-COM, or I3-COM terminals, according to the input current. Malfunctions may occur if the input is connected to unused terminals and the Unit will not operate correctly.

Terminal I1 is not used by the K8AB-AS3.

If using the OMRON K8AC-CT200L CT, connect to terminals k and l on the K8AC-CT200L. (Terminals kt and lt are not used.)

2. Power Supply

Connect the power supply to terminals A1 and A2.

3. Outputs

SPDT relays are output to terminals 11, 12, and 14.

Note: Use the recommended ferrules if using twisted wires.

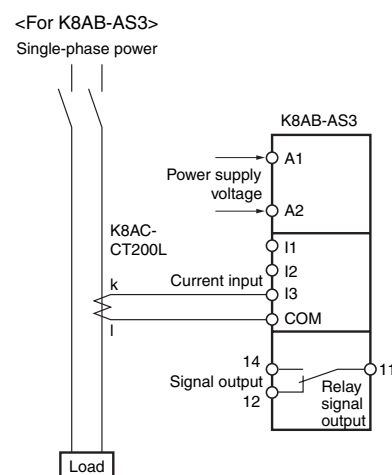

DIP Switch Settings

The resetting method, relay drive method, and operating mode are set using the DIP switch located on the bottom of the Unit.

K8AB-AS□ does not use SW1.

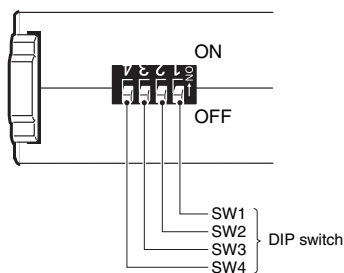

DIP Switch Functions

SWITCH	ON ● ↑ OFF ○ ↓	4 ON ● OFF ○	3	2	1
Resetting method	Automatic reset	---	---	●	NO USE
	Manual reset	---	---	○	
Relay drive method	Normally closed	---	●	---	
	Normally open	---	○	---	
Operating mode	Undercurrent	●	---	---	
	Overcurrent	○	---	---	

Note: All pins are set to OFF at the factory.

Setting Method

1. Setting Current

The current knob (SV) is used to set the current.

The current can be set to 10% to 100% of the maximum measuring current.

Turn the knob while there is an input to the input terminals until the alarm indicator flashes (when the set value and the input have reached the same level.)

Use this as a guide to set the current.

The maximum measuring current will differ depending on the model and the input terminal.

Example: K8AB-AS3 Using Input Terminals I3-COM

The maximum measuring current will be 200 A AC and the setting range will be 20 to 200 A.

2. Hysteresis

Hysteresis is set using the hysteresis knob (HYS.)

The setting range is 5 to 50% of the operating value.

Turn the knob while there is an input to the input terminals until the alarm indicator flashes (when the set value and the input have reached the same level.)

Use this as a guide to set the hysteresis.

Example: Maximum of 200 A AC, Current Setting (SV) of 50%, and Overcurrent Operation

Operation will be at 100 A and resetting at 90 A when the hysteresis (HYS.) is set to 10%.

3. Operating Time

The operating time is set using the operating time knob (T).

The operating time can be set to between 0.1 and 30 s.

Turn the knob while there is an input to the input terminals until the alarm indicator flashes (when the set value and the input have reached the same level.)

Use this as a guide to set the operating time.

If the input current exceeds (drops lower than) the current setting, the alarm indicator will start flashing for the set period and then stay lit.

4. Startup Lock Time

The startup lock time is set using the startup lock time knob (LOCK).

The startup lock time can be set to between 0 and 30 s.

Turn the knob while there is an input to the input terminals until the alarm indicator flashes (when the set value and the input have reached the same level.)

Use this as a guide to set the startup lock time.

The startup lock time will start when the input current reaches 30% or more of the current setting.

Use startup lock time to prevent unwanted operation, e.g., as a result of inrush current.

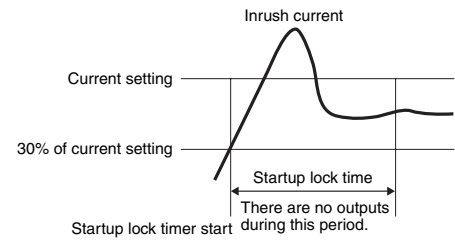

Dimensions

(Unit: mm)

Single-phase Current Relays

K8AB-AS1
K8AB-AS2
K8AB-AS3

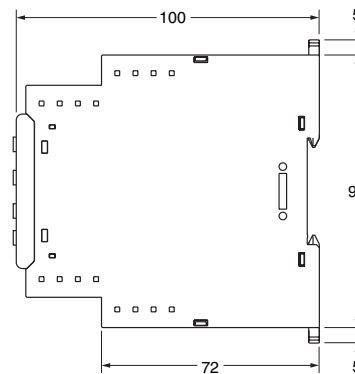
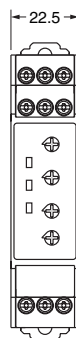
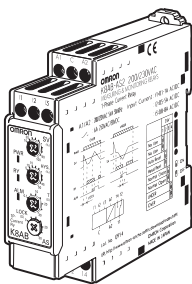

OMRON CT

K8AC-CT200L

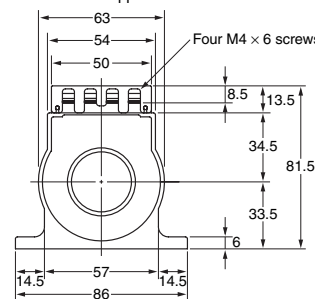
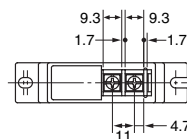
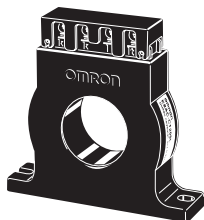

Mounting Hole Dimensions

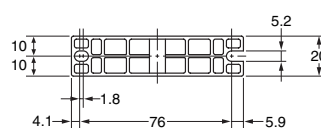
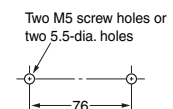

Note: The OMRON Current Transformer (CT) is designed to be used with the K8AB-AS3. Use terminals k and l for connections. (Terminals kt and lt are not used.)

Questions and Answers

Q Checking Operation

A Overcurrents
Gradually increase the input from 80% of the setting. The input will equal the operating value when the input exceeds the setting and the alarm indicator starts flashing. Operation can be checked by the relay outputs that will start after the operating time has passed.

Undercurrent
Gradually decrease the input from 120% of the setting and check the operation using the same method as for overcurrent.

Example: Overcurrent Operating Mode, Normally Open Relay Drive, and an Operating Time of 5 s

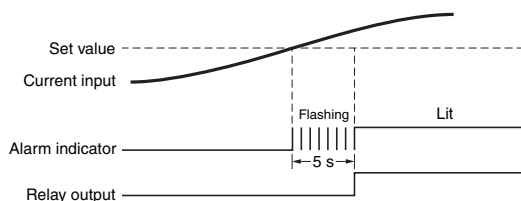

Connection Diagram

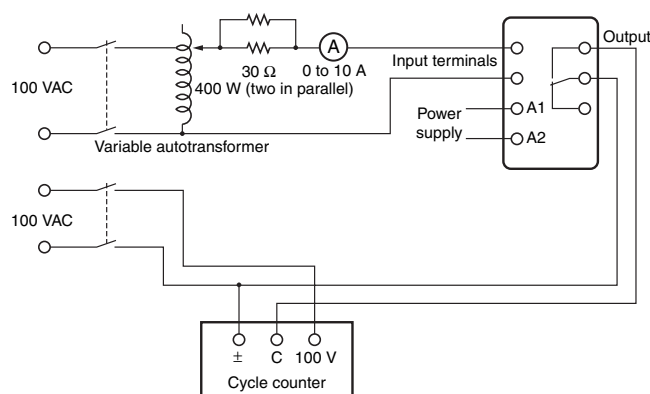

Q How to Measure the Operating Time

A Overcurrent
Change the input suddenly from 0% to 120% of the set value and measure the time until the Unit operates.

Undercurrent
Change the input suddenly from 120% to 0% of the set value and measure the time until the Unit operates.

Q Monitoring Switch-mode Power Supplies

A Switch-mode Power Supplies cannot be monitored. In circuits with a capacitor input, including switch-mode power supplies, the input capacitor recharge current flows in pulse form as the load current. The K8AB-AS□ has a built-in filter as a countermeasure against high frequencies and cannot be used to remove pulse current.

Q Operating Adjustment Knobs

A Use a screwdriver to turn the knobs. There is a stopper to prevent the knob from turning any further once it has been turned completely to the left or right. Do not force the knob past these limits.

Q Can a motor with a rated current of 5 A be monitored using the K8AB? Are there any application precautions?

A The K8AB-AS1 and K8AB-AS2 cannot be used with motor loads. Use the K8AB-AS3 in combination with the K8AC-CT200L Current Transformer (CT). With motor loads, the startup current and stall current will cause a current of many times the rated current to flow. Refer to the following figure for information on the motor startup current.

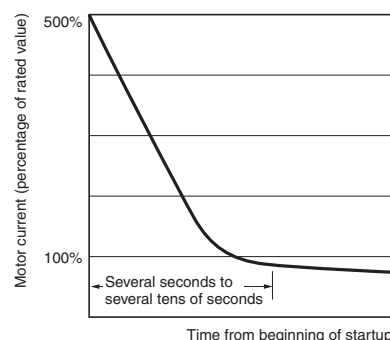

For a motor with a rating of 5 A, the startup current will be approximately 30 A. The startup current will exceed the overload capacity (rating: 150% for 1 s) of the K8AB-AS1 and K8AB-AS2 and result in failure of the Relay. To monitor the motor load, use the K8AB-AS3. (Overload capacity: 120% of rating for continuous load, 200% of rating for 30 s, and 600% of rating for 1 s). The K8AB-AS3 has a large input range. Pass the conductors multiple times through the special CT.

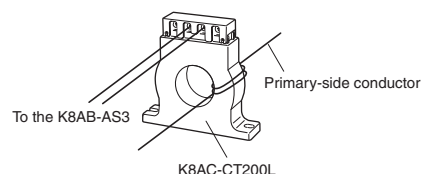

Concept behind Passing Conductor through the CT When Using the K8AB-AS3

Example: Monitoring Overload of a Motor with a Rated Current of 5 A

K8AB settings:
Overcurrent detection, operating value setting: 25%, operating time: 0.1 s
Startup lock timer: 0.1 to 30 s (Set the timer according to the duration of the startup current.)

The setting range for the K8AB-AS3 is 10% to 100% of the rated current (i.e., 10 to 100 A). Pass the conductors through the CT five times so that at least 10 A of current flows. The input current to the K8AB will be 25 A (i.e., 5 A x 5 loops).

If a startup current of six times the rated current is generated, it will be 150 A (i.e., 25 A x 6). The overload capacity for the K8AB-AS3 is 200% of the rating for 30 s. The Relay will not fail even if the startup current continues for 30 s, and it is possible to perform overload detection.

ALL DIMENSIONS SHOWN ARE IN MILLIMETERS.

To convert millimeters into inches, multiply by 0.03937. To convert grams into ounces, multiply by 0.03527.

In the interest of product improvement, specifications are subject to change without notice.

Read and Understand This Catalog

Please read and understand this catalog before purchasing the products. Please consult your OMRON representative if you have any questions or comments.

Warranty and Limitations of Liability

WARRANTY

OMRON's exclusive warranty is that the products are free from defects in materials and workmanship for a period of one year (or other period if specified) from date of sale by OMRON.

OMRON MAKES NO WARRANTY OR REPRESENTATION, EXPRESS OR IMPLIED, REGARDING NON-INFRINGEMENT, MERCHANTABILITY, OR FITNESS FOR PARTICULAR PURPOSE OF THE PRODUCTS. ANY BUYER OR USER ACKNOWLEDGES THAT THE BUYER OR USER ALONE HAS DETERMINED THAT THE PRODUCTS WILL SUITABLY MEET THE REQUIREMENTS OF THEIR INTENDED USE. OMRON DISCLAIMS ALL OTHER WARRANTIES, EXPRESS OR IMPLIED.

LIMITATIONS OF LIABILITY

OMRON SHALL NOT BE RESPONSIBLE FOR SPECIAL, INDIRECT, OR CONSEQUENTIAL DAMAGES, LOSS OF PROFITS OR COMMERCIAL LOSS IN ANY WAY CONNECTED WITH THE PRODUCTS, WHETHER SUCH CLAIM IS BASED ON CONTRACT, WARRANTY, NEGLIGENCE, OR STRICT LIABILITY.

In no event shall the responsibility of OMRON for any act exceed the individual price of the product on which liability is asserted.

IN NO EVENT SHALL OMRON BE RESPONSIBLE FOR WARRANTY, REPAIR, OR OTHER CLAIMS REGARDING THE PRODUCTS UNLESS OMRON'S ANALYSIS CONFIRMS THAT THE PRODUCTS WERE PROPERLY HANDLED, STORED, INSTALLED, AND MAINTAINED AND NOT SUBJECT TO CONTAMINATION, ABUSE, MISUSE, OR INAPPROPRIATE MODIFICATION OR REPAIR.

Application Considerations

SUITABILITY FOR USE

OMRON shall not be responsible for conformity with any standards, codes, or regulations that apply to the combination of products in the customer's application or use of the products.

At the customer's request, OMRON will provide applicable third party certification documents identifying ratings and limitations of use that apply to the products. This information by itself is not sufficient for a complete determination of the suitability of the products in combination with the end product, machine, system, or other application or use.

The following are some examples of applications for which particular attention must be given. This is not intended to be an exhaustive list of all possible uses of the products, nor is it intended to imply that the uses listed may be suitable for the products:

- Outdoor use, uses involving potential chemical contamination or electrical interference, or conditions or uses not described in this catalog.
- Nuclear energy control systems, combustion systems, railroad systems, aviation systems, medical equipment, amusement machines, vehicles, safety equipment, and installations subject to separate industry or government regulations.
- Systems, machines, and equipment that could present a risk to life or property.

Please know and observe all prohibitions of use applicable to the products.

NEVER USE THE PRODUCTS FOR AN APPLICATION INVOLVING SERIOUS RISK TO LIFE OR PROPERTY WITHOUT ENSURING THAT THE SYSTEM AS A WHOLE HAS BEEN DESIGNED TO ADDRESS THE RISKS, AND THAT THE OMRON PRODUCTS ARE PROPERLY RATED AND INSTALLED FOR THE INTENDED USE WITHIN THE OVERALL EQUIPMENT OR SYSTEM.

PROGRAMMABLE PRODUCTS

OMRON shall not be responsible for the user's programming of a programmable product, or any consequence thereof.

Disclaimers

CHANGE IN SPECIFICATIONS

Product specifications and accessories may be changed at any time based on improvements and other reasons.

It is our practice to change model numbers when published ratings or features are changed, or when significant construction changes are made. However, some specifications of the products may be changed without any notice. When in doubt, special model numbers may be assigned to fix or establish key specifications for your application on your request. Please consult with your OMRON representative at any time to confirm actual specifications of purchased products.

DIMENSIONS AND WEIGHTS

Dimensions and weights are nominal and are not to be used for manufacturing purposes, even when tolerances are shown.

PERFORMANCE DATA

Performance data given in this catalog is provided as a guide for the user in determining suitability and does not constitute a warranty. It may represent the result of OMRON's test conditions, and the users must correlate it to actual application requirements. Actual performance is subject to the OMRON Warranty and Limitations of Liability.

ERRORS AND OMISSIONS

The information in this document has been carefully checked and is believed to be accurate; however, no responsibility is assumed for clerical, typographical, or proofreading errors, or omissions.

2009.12

In the interest of product improvement, specifications are subject to change without notice.

OMRON Corporation
Industrial Automation Company

<http://www.ia.omron.com/>

(c)Copyright OMRON Corporation 2009 All Right Reserved.