

QUAD OPERATIONAL AMPLIFIERS

The KA248/KA348 is a true quad KA741. It consists of four independent, high-gain, internally compensated, low-power operational amplifiers which have been designed to provide functional characteristics identical to those of the familiar KA741 operational amplifier. In addition the total supply current for all four amplifiers is comparable to the Supply current of a single KA741 type OP Amp.

Other features include input offset currents and input bias current which are much less than those of a standard KA741. Also, excellent isolation between amplifiers has been achieved by independently biasing each amplifier and using layout techniques which minimize thermal coupling.

FEATURES

- KA741 OP Amp operating characteristics
- Low supply current drain
- Class AB output stage-no crossover distortion
- Pin compatible with the KA324 & KA3403
- Low input offset voltage- 1mV Type.
- Low input offset current-4nA Type.
- Low input bias current-30nA Type.
- Gain bandwidth product for KA348 (unity gain)-1.0MHz Type.
- High degree of isolation between amplifiers-120dB
- Overload protection for inputs and outputs

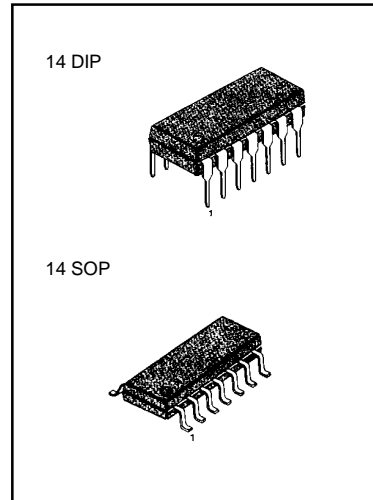

BLOCK DIAGRAM

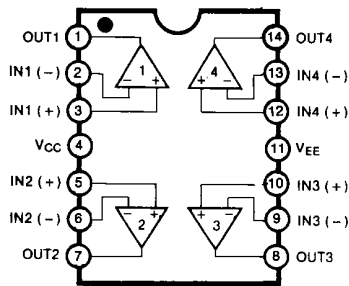

ORDERING INFORMATION

Device	Package	Operating Temperature
KA348	14 DIP	0 ~ +70 °C
KA348D	14 SOP	
KA248	14 DIP	-25 ~ +85 °C
KA248D	14 SOP	

SCHEMATIC DIAGRAM (One Section Only)

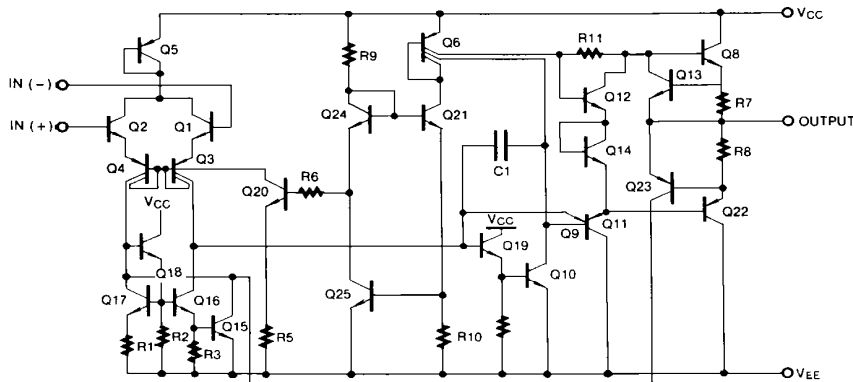

ABSOLUTE MAXIMUM RATINGS ($T_A = 25^\circ\text{C}$)

Characteristic	Symbol	Value	Unit
Supply Voltage	V_{CC}	± 18	V
Differential Input Voltage	$V_{I(DIFF)}$	± 36	V
Input Voltage	V_i	± 18	V
Output Short Circuit Duration		Continuous	
Operating Temperature KA248	T_{OPR}	- 25 ~ +85	$^\circ\text{C}$
KA348		0~ +70	$^\circ\text{C}$
Storage Temperature	T_{STG}	- 65~ +150	$^\circ\text{C}$

ELECTRICAL CHARACTERISTICS

(V_{CC} = 15V, V_{EE} = -15V, T_A = 25 $^\circ\text{C}$, unless otherwise specified)

Characteristic	Symbol	Test Conditions	KA248			KA348			Unit
			Min	Typ	Max	Min	Typ	Max	
Input Offset Voltage	V_{IO}	$R_S \leq 10\text{K}\Omega$		1	6.0		1	6.0	mV
			NOTE 1		7.5		7.5		
Input Offset Current	I_{IO}			4	50		4	50	nA
			NOTE 1		125		100		
Input Bias Current	I_{BIAS}			30	200		30	200	nA
			NOTE 1		500		400		
Input Resistance	R_i		0.8	2.5		0.8	2.5	$M\Omega$	
Supply Current (all Amplifiers)	I_{CC}			2.4	4.5		2.4	4.5	mA
Large Signal Voltage Gain	G_V	$R_L \geq 2\text{K}\Omega$		25	160		25	160	V/mV
			NOTE 1	15			15		
Channel Separation	CS	f = 1KHz to 20KHz		120			120		dB
Common Mode Input Voltage Range	$V_{I(R)}$	NOTE 1		± 12			± 12		V
Small Signal Bandwidth	BW	$G_V = 1$		1.0			1.0		MHz
Phase Margin	MPH	$G_V = 1$		60			60		Degress
Slew Rate	SR	$G_V = 1$		0.5			0.5		V/ μs
Output Short Circuit Current	I_{SC}			25			25		mA
Output Voltage Swing	$V_{O(P.P)}$	$R_L \geq 10\text{K}\Omega$	NOTE 1	± 12	± 13		± 12	± 13	V
		$R_L \geq 2\text{K}\Omega$		± 10	± 12		+0	± 12	
Common Mode Rejection Ratio	CMRR	$R_S \geq 10\text{K}\Omega$	NOTE 1	70	90		70	90	dB
Power Supply Rejection Ratio	PSRR	$R_S \geq 10\text{K}\Omega$	NOTE 1	77	96		77	96	dB

NOTE 1

KA348: $0 \geq T_A \geq +70^\circ\text{C}$
 KA248: $-25 \geq T_A \geq +85^\circ\text{C}$

TYPICAL PERFORMANCE CHARACTERISTICS

Fig. 1 SUPPLY CURRENT

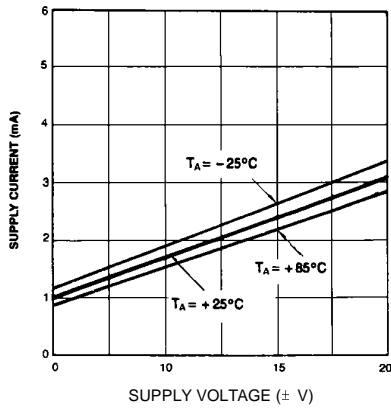

Fig. 2 VOLTAGE SWING

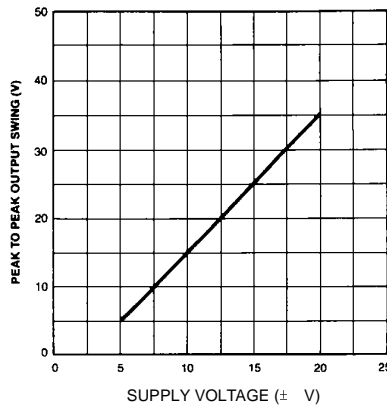

Fig. 3 SOURCE CURRENT LIMIT

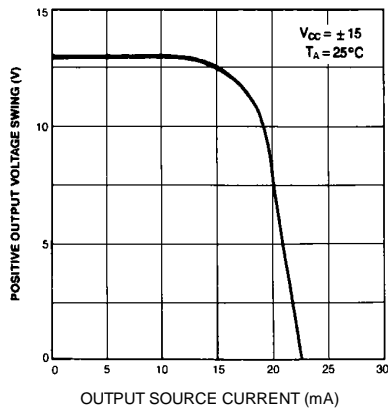

Fig. 4 SINK CURRENT LIMIT

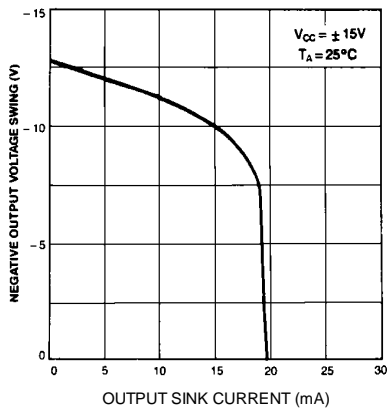

Fig. 5 OUTPUT IMPEDANCE

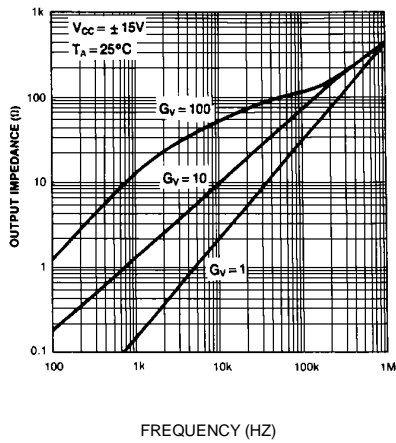

Fig. 6 COMMON-MODE REJECTION RATIO

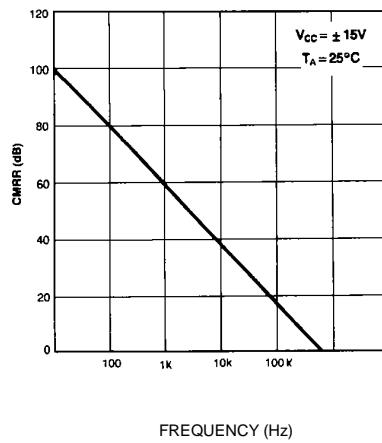

Fig. 7 OPEN LOOP FREQUENCY RESPONSE

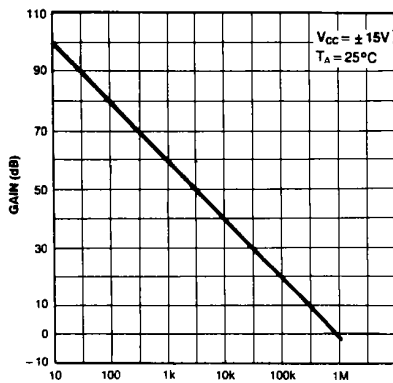

Fig. 8 BODE PLOT

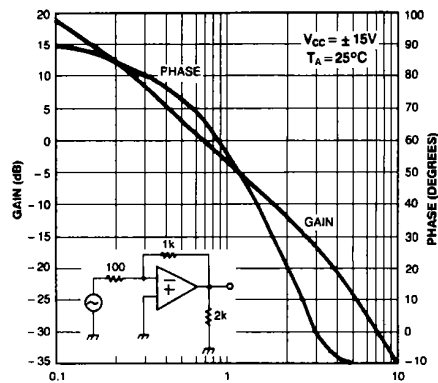

Fig. 9 LARGE SIGNAL PULSE RESPONSE

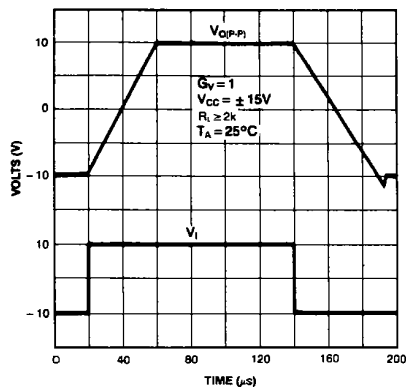

Fig. 10 SMALL SIGNAL PULSE RESPONSE

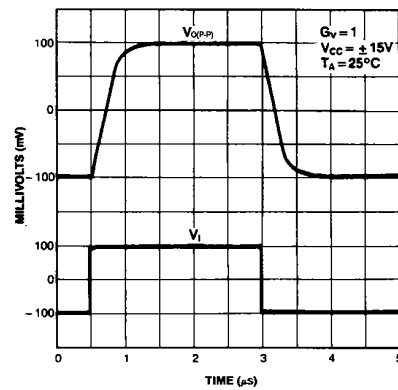

Fig. 11 UNDISTORTED OUTPUT VOLTAGE SWING

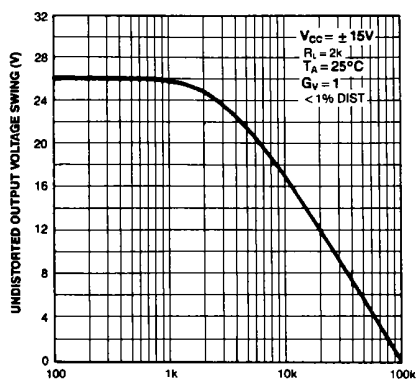

Fig. 12 INVERTING LARGE SIGNAL PULSE RESPONSE

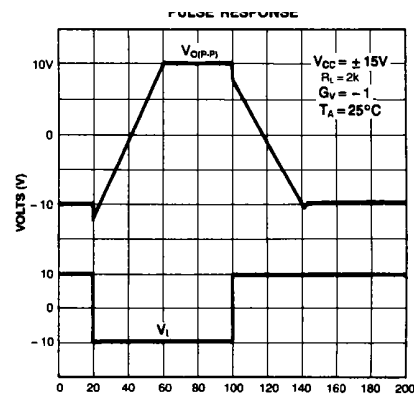

Fig. 13 INPUT NOISE VOLTAGE AND NOISE CURRENT

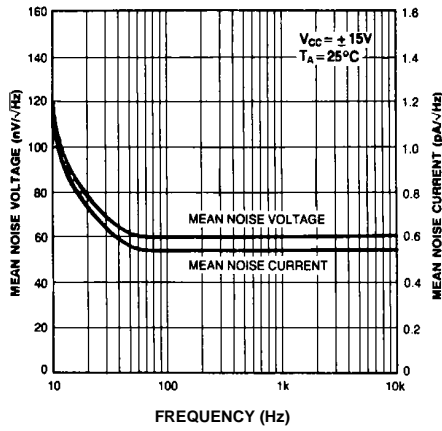

Fig. 14 POSITIVE COMMON MODE INPUT VOLTAGE LIMIT

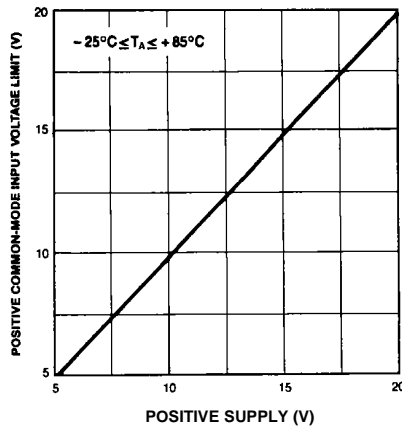
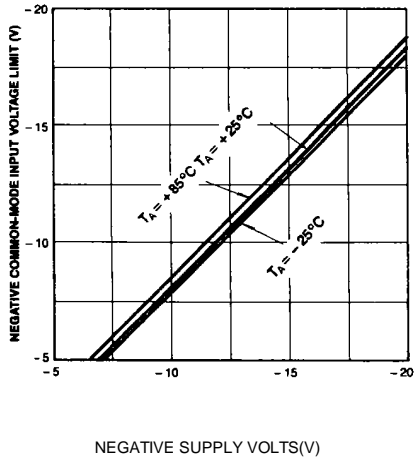
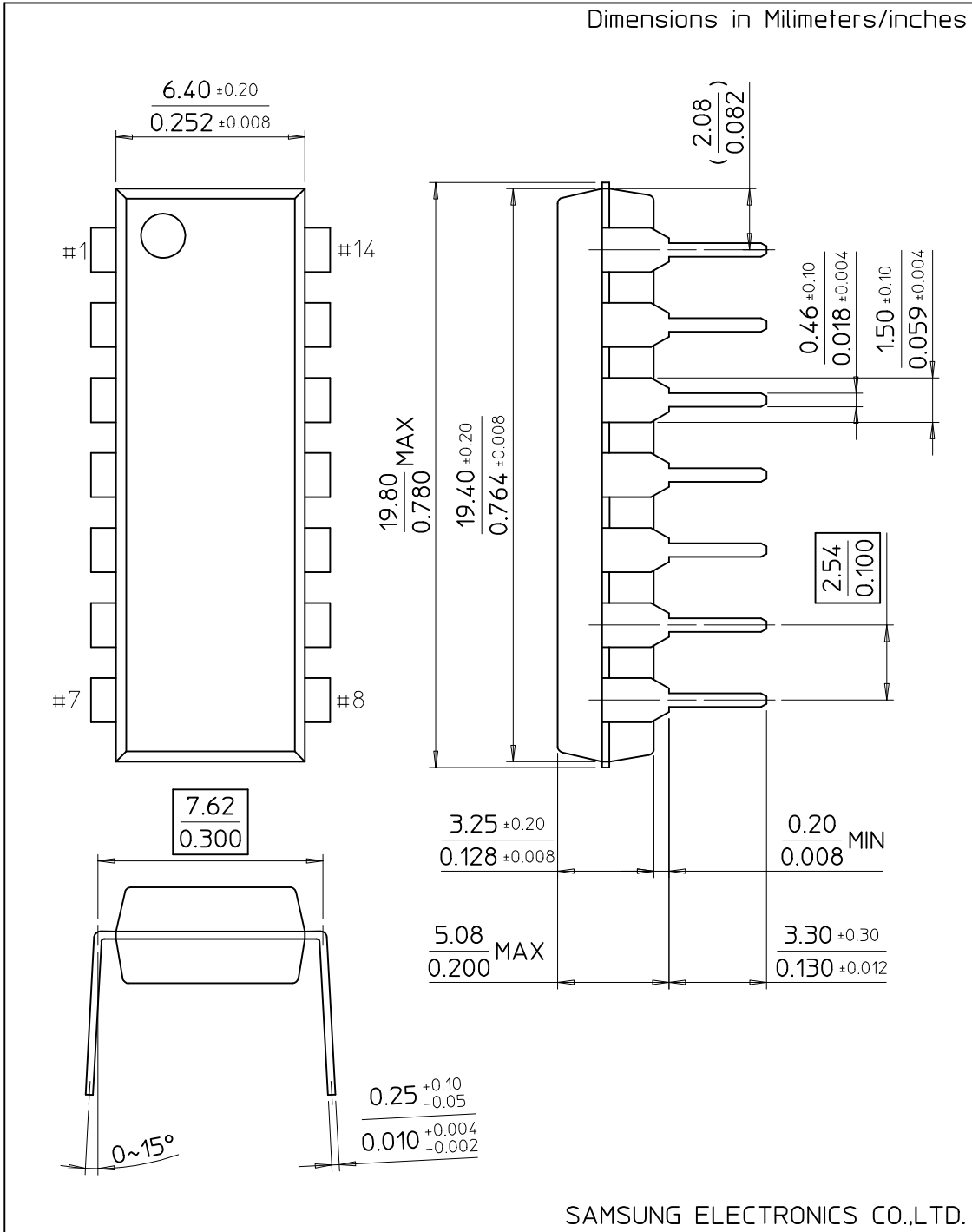

Fig. 15 NEGATIVE COMMON-MODE INPUT VOLTAGE LIMIT



14-DIP-300

Dimensions in Millimeters/inches



SAMSUNG ELECTRONICS CO.,LTD.

14-SOP-225B

Dimensions in Millimeters/inches

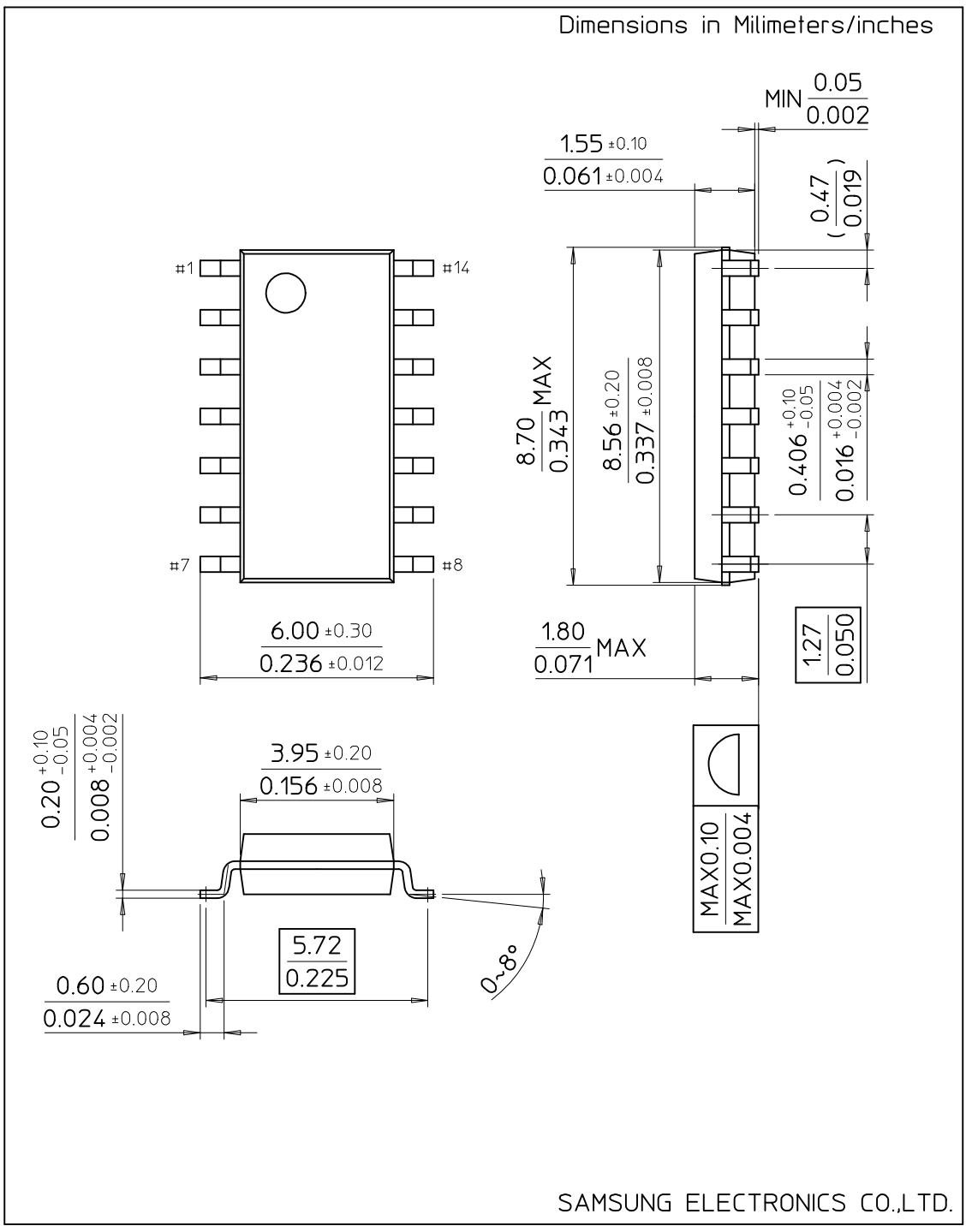

SAMSUNG ELECTRONICS CO.,LTD.