

**GENERAL DESCRIPTION**

The KA3511/D is a fixed-frequency improved-performance pulse-width modulation control circuit with complete housekeeping circuitry for use in the secondary side of SMPS (Switched mode power supply). It contains various functions, which are precision voltage reference, over voltage protection, under voltage protection, remote on/off control, power good signal generator and etc.

**OVP (Over voltage protection) section**

It has OVP functions for +3.3V,+5V,+12V and PT outputs. The circuit is made up of a comparator with four detecting inputs and without hysteresis voltage. Especially, PT (Pin16) is prepared for an extra OVP input or another protection signal.

**UVP (Under voltage protection) section**

It also has UVP functions for +3.3V, +5V, +12V outputs. The block is made up of a comparator with three detecting inputs and without hysteresis voltage.

**Remote on/off section**

Remote on/off section is used to control SMPS externally. If a high signal is supplied to the remote on/off input, PWM signal becomes a high state and all secondary outputs are grounded. The remote on/off signal is transferred with some on-delay and off-delay time of 8ms, 24ms respectively.

**Precision reference section**

The reference voltage trimmed to  $\pm 2\%$   
( $4.9V \leq V_{ref} \leq 5.1V$ )

**PG (Power good signal generator) section**

Power good signal generator is to monitor the voltage level of power supply for safe operation of a microprocessor.

KA3511 requires few external components to accomplish a complete housekeeping circuits for SMPS. The KA3511 is available in a 22-pin dual in-line package.



**ORDERING INFORMATION**

Device	Package	Operating Temperature
KA3511	22 DIP	-25°C ~ 85°C
KA3511D	24 SOP	-25°C ~ 85°C

**FEATURES**

- Complete PWM control and house keeping circuitry
- Few external components
- Precision voltage reference trimmed to 2%
- Dual output for push-pull operation
- Each output TR for 200mA sink current
- Variable duty cycle by dead time control
- Soft start capability by using dead time control
- Double pulse suppression logic
- Over voltage protection for 3.3V / 5V / 12V
- Under voltage protection for 3.3V / 5V / 12V
- One more external input for various protection (PT)
- Remote on/off control function (PS-ON)
- Latch function controlled by remote and protection input
- Power good signal generator with hysteresis

BLOCK DIAGRAM

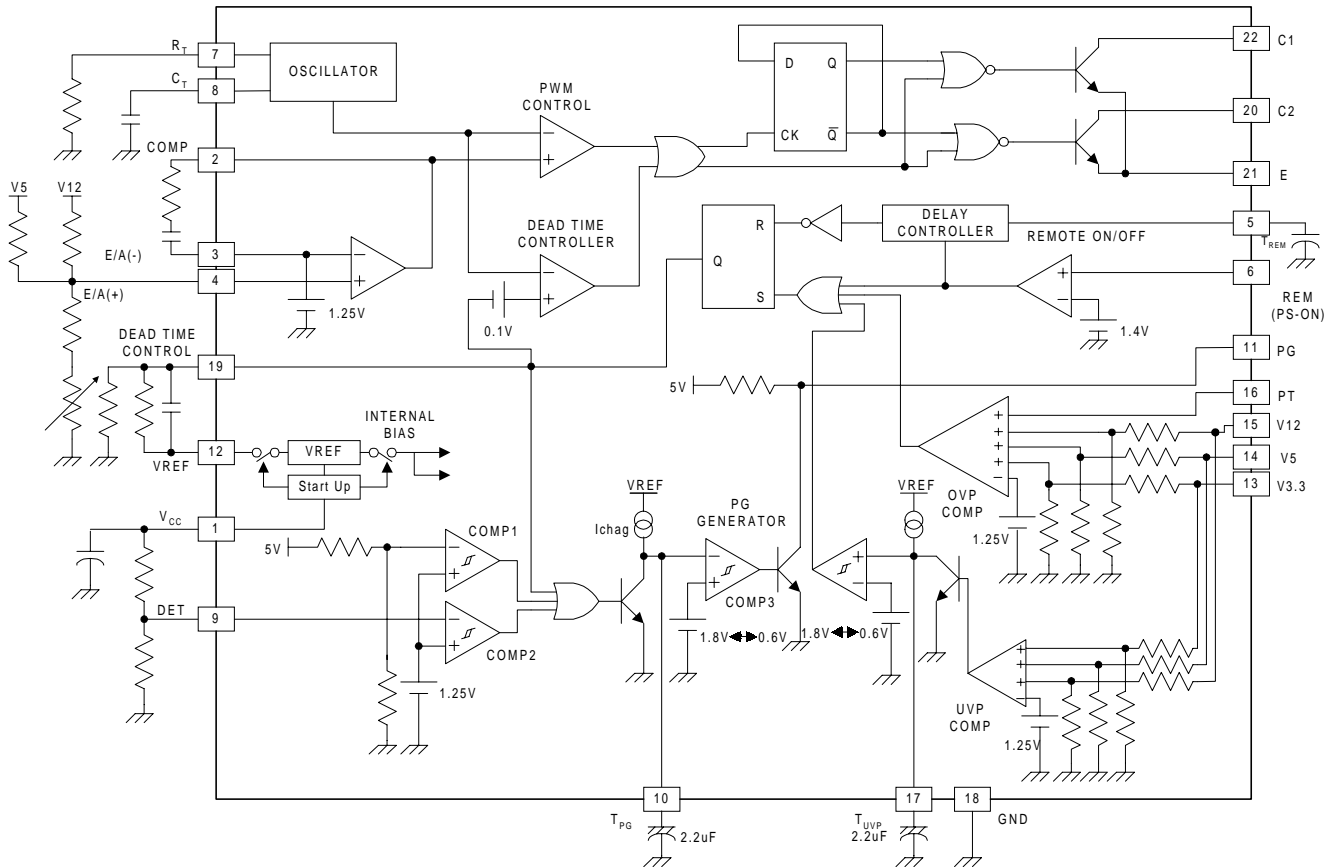

**PIN DESCRIPTION : KA3511**

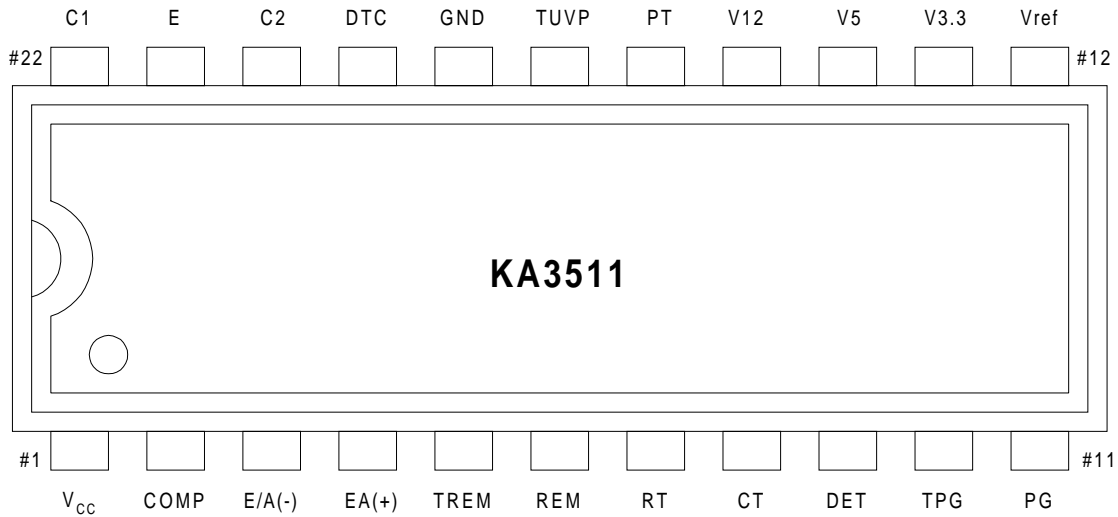

Pin No.	Name	I/O	Function	Pin No.	Name	I/O	Function
1	V <sub>CC</sub>	I	Supply voltage	12	Vref	O	Precision reference VTG
2	COMP	O	E/A output	13	V3.3	I	OVP, UVP input for 3.3V
3	E/A(-)	I	E/A (-) input	14	V5	I	OVP, UVP input for 5V
4	E/A(+)	I	E/A (+) input	15	V12	I	OVP, UVP input for 12V
5	TREM	-	Remote on/off delay	16	PT	I	Extra protection input
6	REM	I	Remote on/off input	17	T <sub>UVP</sub>	-	UVP delay
7	RT	-	Oscillation freq. setting R	18	GND	-	Signal ground
8	CT	-	Oscillation freq. setting C	19	DTC	I	Deadtime control input
9	DET	I	Detect input	20	C2	O	Output 2
10	T <sub>PG</sub>	-	PG delay	21	E	-	Power ground
11	PG	O	Power good signal output	22	C1	O	Output 1

## PIN DESCRIPTION : KA3511D

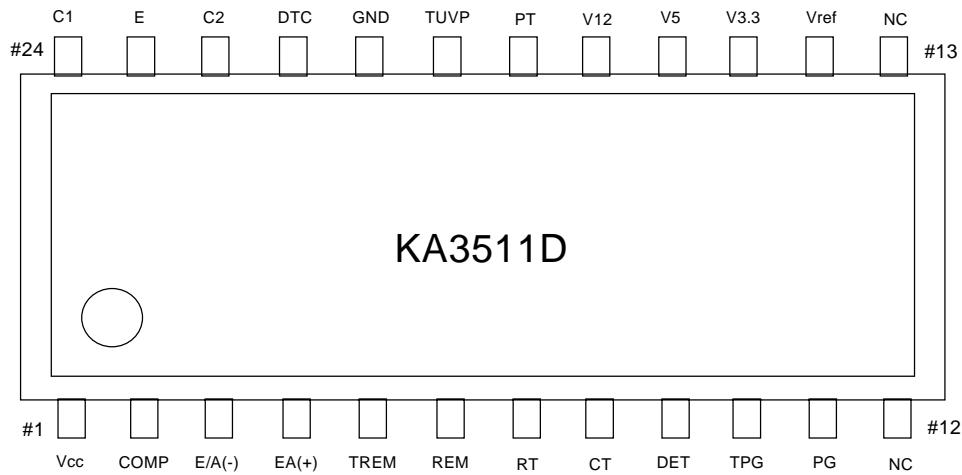

Pin No.	Name	I/O	Function	Pin No.	Name	I/O	Function
1	V <sub>CC</sub>	I	Supply voltage	13	NC	-	NC
2	COMP	O	E/A output	14	Vref	O	Precision reference VTG
3	E/A(-)	I	E/A (-) input	15	V3.3	I	OVP, UVP input for 3.3V
4	E/A(+)	I	E/A (+) input	16	V5	I	OVP, UVP input for 5V
5	TREM	-	Remote on/off delay	17	V12	I	OVP, UVP input for 12V
6	REM	I	Remote on/off input	18	PT	I	Extra protection input
7	RT	-	Oscillation freq. setting R	19	T <sub>UVP</sub>	-	UVP delay
8	CT	-	Oscillation freq. setting C	20	GND	-	Signal ground
9	DET	I	Detect input	21	DTC	I	Deadtime control input
10	T <sub>PG</sub>	-	PG delay	22	C2	O	Output 2
11	PG	O	Power good signal output	23	E	-	Power ground
12	NC	-	NC	24	C1	O	Output 1

Pin No.	Name	Function
1	V <sub>CC</sub>	Supply voltage. Operating range is 14V~30V. V <sub>CC</sub> =20V, Ta=25°C at test.
2	COMP	Error amplifier output. It is connect to non-inverting input of pulse width modulator comparator.
3	E/A(-)	Error amplifier inverting input. Its reference voltage is always 1.25V.
4	E/A(+)	Error amplifier non-inverting input feedback voltage. This pin may be used to sense power supply output voltage.
5	TREM	Remote on/off delay. Ton/Toff=8ms/24ms (Typ.) with C=0.1uF. Its high/low threshold voltage is 1.8V/0.6V.
6	REM	Remote on/off input. It is TTL operation and its threshold voltage is 1.4V. Voltage at this pin can reach normal 4.6V, with absolutely maximum voltage, 5.25V. If REM = "Low", PWM = "Low". That means the main SMPS is operational. When REM = "High", then PWM = "High" and the main SMPS is turned-off.
7	RT	Oscillation frequency setting R. (Test Condition RT=10kΩ)
8	CT	Oscillation frequency setting C. (Test Condition CT=0.01uF)
9	DET	Under-voltage detect pin. Its threshold voltage is 1.25V Typ.
10	T <sub>PG</sub>	PG delay. Td=250ms (Typ) with CPG=2.2uF. The high/low threshold voltage are 1.8V/0.6V and the voltage of Pin10 is clamped at 2.9V for noise margin.
11	PG	Power good output signal. PG = "High" means that the power is "Good" for operation and PG = "Low" means "Power fail".
12(14)	Vref	Precision voltage reference trimmed to 2%. (Typical Value = 5.03V)
13(15)	V3.3	Over voltage protection for output 3.3V. (Typical Value = 4.1V)
14(16)	V5	Over voltage protection for output 5V. (Typical Value = 6.2V)
15(17)	V12	Over voltage protection for output 12V. (Typical Value = 14.2V)
16(18)	PT	This is prepared for an extra OVP input or another protection signal. (Typical Value = 1.25V)
17(19)	T <sub>UVP</sub>	Timing pin for under voltage protection blank-out time. Its threshold voltage is 1.8V and clamped at 2.9V after full charging. Target of delay time is 250ms and it is realized through external (C=2.2uF).
18(20)	GND	Signal ground.
19(21)	DTC	Deadtime control input. The dead-time control comparator has an effective 120mV input offset which limits the minimum output dead time. Dead time may be imposed on the output by setting the dead time control input to a fixed voltage, ranging between 0V to 3.3V.
20(22)	C2	Output drive pin for push-pull operation.
21(23)	E	Power ground.
22(24)	C1	Output drive pin for push-pull operation.

## ABSOLUTE MAXIMUM RATINGS

Characteristic	Symbol	Value	Unit
Supply voltage	$V_{CC}$	40	V
Collector output voltage	$V_{C1}, V_{C2}$	40	V
Collector output current	$I_{C1}, I_{C2}$	200	mA
Power dissipation(KA3511D)	$P_D$	0.8	W
Power dissipation(KA3511)	$P_D$	1.5	W
Operating temperature	$T_{OPR}$	-25 to 85	°C
Storage temperature	$T_{STG}$	-65 to 150	°C

## TEMPERATURE CHARACTERISTICS

Characteristic	Symbol	Value			Unit
		Min.	Typ.	Max.	
Temperature coefficient of Vref (-25°C ≤ Ta ≤ 85°C)	$\Delta V_{ref}/\Delta T$	-	0.01	-	%/°C

**ELECTRICAL CHARACTERISTICS** ( $V_{CC}=20V$ ,  $T_A=25^\circ C$ )

Characteristic	Symbol	Test Condition	Value			Unit
			Min.	Typ.	Max.	
<b>REFERENCE SECTION</b>						
Reference output voltage	Vref	Iref=1mA	4.9	5	5.1	V
Line regulation	$\Delta V_{ref\_LINE}$	$14V \leq V_{CC} \leq 30V$	–	2.0	25	mV
Load regulation	$\Delta V_{ref\_LOAD}$	$1mA \leq I_{ref} \leq 10mA$	–	1.0	15	mV
Temperature coefficient of Vref <sup>(1)</sup>	$\Delta V_{ref}/\Delta T$	$-25^\circ C \leq T_a \leq 85^\circ C$	–	0.01	–	%/°C
Short-circuit output current	I <sub>SC</sub>	Vref=0	15	35	75	mA
<b>OSCILLATOR SECTION</b>						
Oscillation frequency	fosc	C <sub>T</sub> =0.01uF, R <sub>T</sub> =12k	–	10	–	kHz
Frequency change with temperature <sup>(1)</sup>	fosc/T	C <sub>T</sub> =0.01uF, R <sub>T</sub> =12k	–	2	–	%
<b>DEAD TIME CONTROL SECTION</b>						
Input bias current	I <sub>B(DT)</sub>		–	-2.0	-10	uA
Maximum duty voltage	DC <sub>MAX</sub>	Pin19 (DTC)=0V	45	48	50	%
Input threshold voltage	V <sub>TH(DT)</sub>	Zero Duty Cycle	–	3.0	3.3	V
		Max. Duty Cycle	0	–	–	
<b>ERROR AMP SECTION</b>						
Inverting reference voltage	Vref(EA)		1.20	1.25	1.30	V
Input bias current	I <sub>B(EA)</sub>	V <sub>COMP</sub> =2.5V	–	-0.1	-1.0	uA
Open-loop voltage gain <sup>(1)</sup>	G <sub>VO</sub>	$0.5V \leq V_{COMP} \leq 3.5V$	70	95	–	dB
Unit-gain bandwidth <sup>(1)</sup>	BW		–	650	–	kHz
Output sink current	I <sub>SINK</sub>	V <sub>COMP</sub> =0.7V	0.3	0.9	–	mA
Output source current	I <sub>SOURCE</sub>	V <sub>COMP</sub> =3.5V	-2.0	-4.0	–	mA
<b>PWM COMPARATOR SECTION</b>						
Input threshold voltage	V <sub>TH(PWM)</sub>	Zero Duty Cycle	–	4	4.5	V
<b>OUTPUT SECTION</b>						
Output saturation voltage	V <sub>CE(SAT)</sub>	I <sub>C</sub> =200mA	–	1.1	1.3	V
Collector off-state current	I <sub>C(off)</sub>	V <sub>CC</sub> =V <sub>C</sub> =30V, V <sub>E</sub> =0V	–	2	100	uA
Rising time	T <sub>R</sub>		–	100	200	ns
Falling time	T <sub>F</sub>		–	50	200	ns
<b>PROTECTION SECTION</b>						
Over voltage protection for 3.3V	V <sub>OVP1</sub>		3.8	4.1	4.3	V

## ELECTRICAL CHARACTERISTICS (continued)

Characteristic	Symbol	Test Condition	Value			Unit
			Min.	Typ.	Max.	
Over voltage protection for 5V	$V_{OVP2}$	–	5.8	6.2	6.6	V
Over voltage protection for 12V	$V_{OVP3}$	–	13.5	14.2	15.0	V
Input threshold voltage for PT	$V_{PT}$	–	1.20	1.25	1.30	V
Under voltage protection for 3.3V	$V_{UVP1}$	–	2.1	2.3	2.5	V
Under voltage protection for 5V	$V_{UVP2}$	–	3.7	4.0	4.3	V
Under voltage protection for 12V	$V_{UVP3}$	–	9.2	10	10.8	V
Charging current for UVP delay	$I_{CHG.UVP}$	$C=2.2\mu F, V_{TH}=1.8V$	–10	–15	–23	$\mu A$
UVP Delay Time	$T_{D.UVP}$	$C=2.2\mu F$	100	260	500	ms
<b>REMOTE ON/OFF SECTION</b>						
REM on input voltage	$V_{REMH}$	$I_{REM}=-200\mu A$	2.0	–	–	V
REM off input voltage	$V_{REML}$	–	–	–	0.8	V
REM off input bias voltage	$I_{REML}$	$V_{REM}=0.4V$	–	–	–1.6	$mA$
REM on open voltage	$V_{REM(OPEN)}$	–	2.0	–	5.25	V
REM on delay time	$T_{on}$	$C=0.1\mu F$	4	8	14	ms
REM off delay time	$T_{off}$	$C=0.1\mu F$	16	24	34	ms
<b>REMOTE ON/OFF SECTION <sup>(2)</sup></b>						
Detecting input voltage	$V_{IN(DET)}$	–	1.20	1.25	1.30	V
Detecting V5 voltage	$V5(DET)$	–	4.1	4.3	4.5	V
Hysteresis voltage 1	HY1	COMP1, 2	10	40	80	mV
Hysteresis voltage 2	HY2	COMP3	0.6	1.2	–	V
PG output load resistor	$R_{PG}$	–	0.5	1	2	$k\Omega$
Charging current for PG delay	$I_{CHG.PG}$	$C=2.2\mu F, V_{TH}=1.8V$	–10	–15	–23	$\mu A$
PG delay time	$T_{D.PG}$	$C=2.2\mu F$	100	260	500	ms
PG output saturation voltage	$V_{SAT(PG)}$	$I_{PG}=10mA$	–	0.2	0.4	V
<b>TOTAL DEVICE</b>						
Standby supply current	$I_{CC}$	–	–	10	20	$mA$

**Notes:**

1. These Parameters, although guaranteed over their recommended operating conditions are not 100% tested in production.
2. REM on delay time (Pin6 REM: “L” → “H”),  
REM off delay time (Pin6 REM: “H” → “L”)



APPLICATION INFORMATIONS

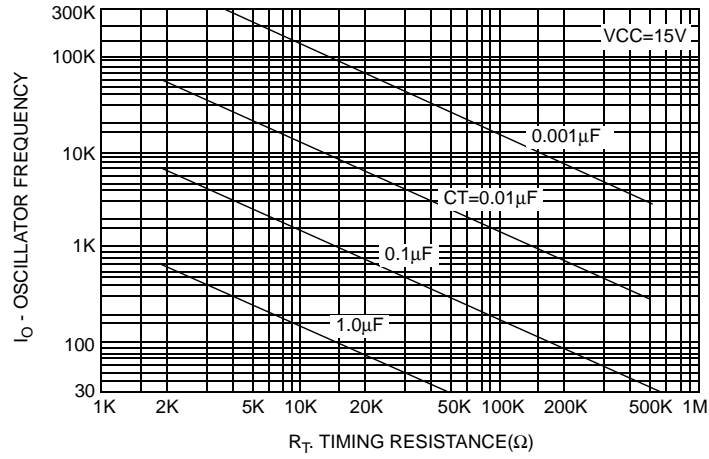

Figure 1. Oscillator Frequency vs. Timing Resistance

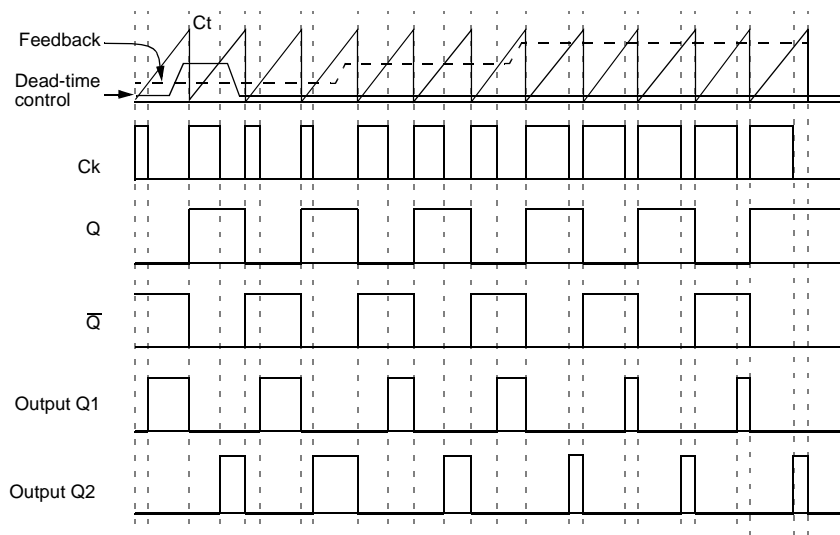
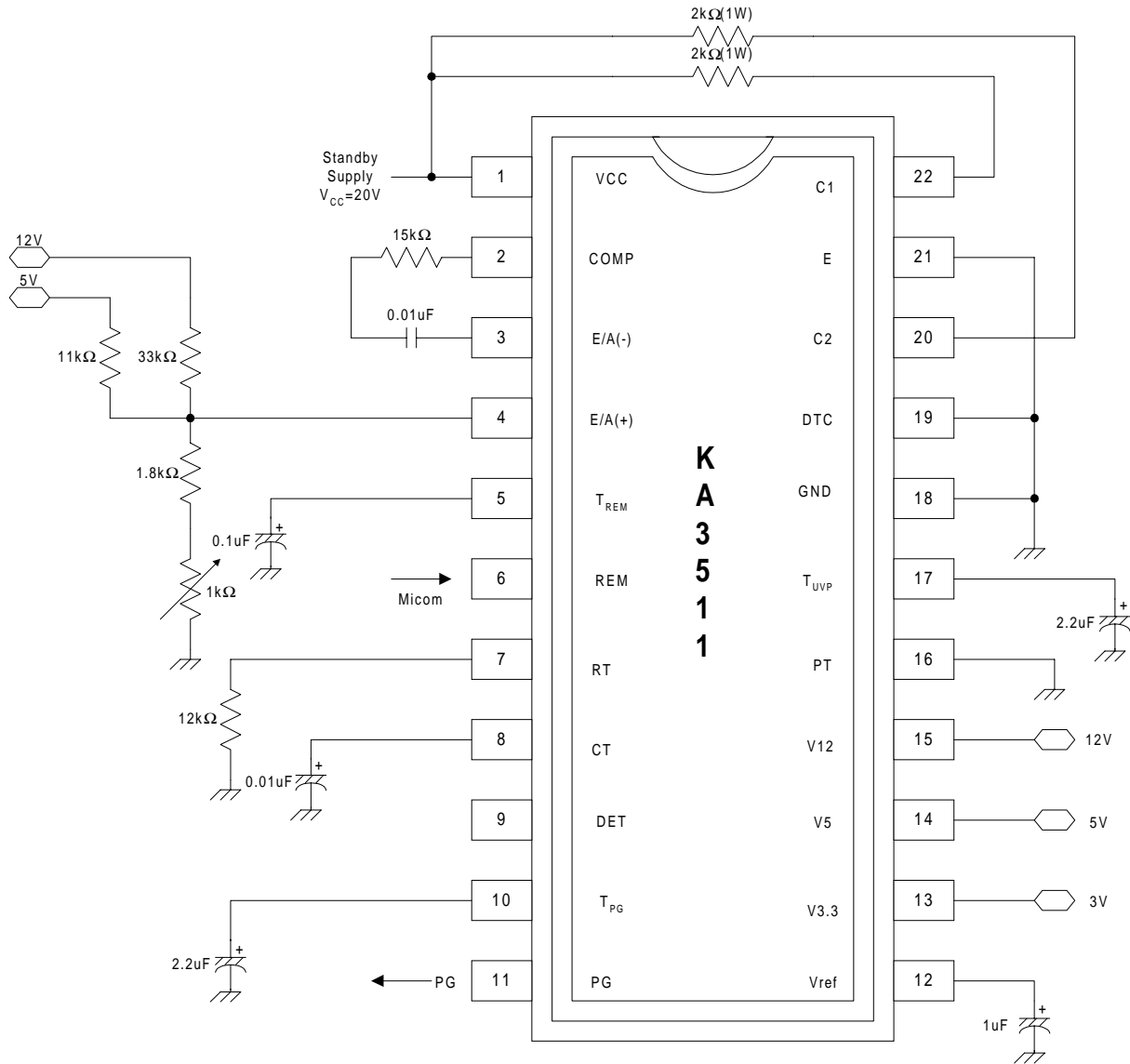

Figure 2. Operating Waveform

HOUSEKEEPING CIRCUIT



Note) The KA3511 requires few external components to accomplish a complete housekeeping circuits for SMPS.

TYPICAL CHARACTERISTICS

$V_{CC}-I_{CC}$

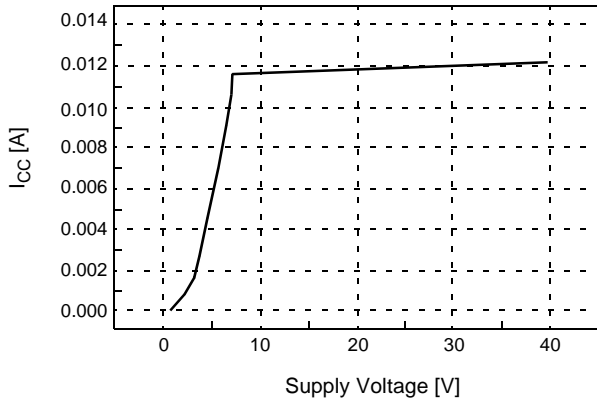

Bandgap Reference Voltage Temperature Characteristic

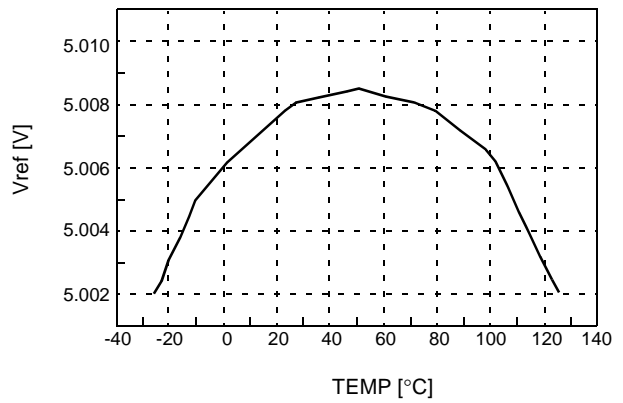

PIN19(Dead Time Control Voltage)-Duty Cycle

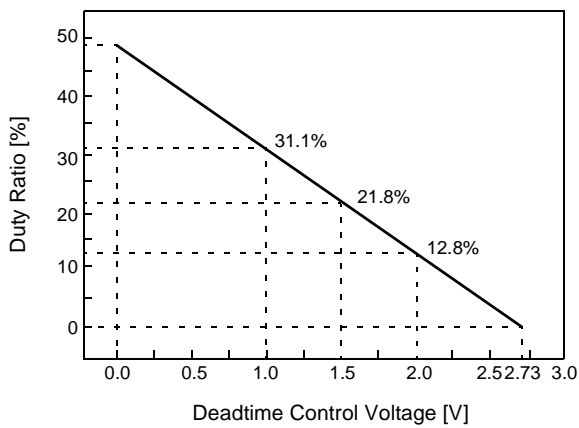

OVP for 3.3V

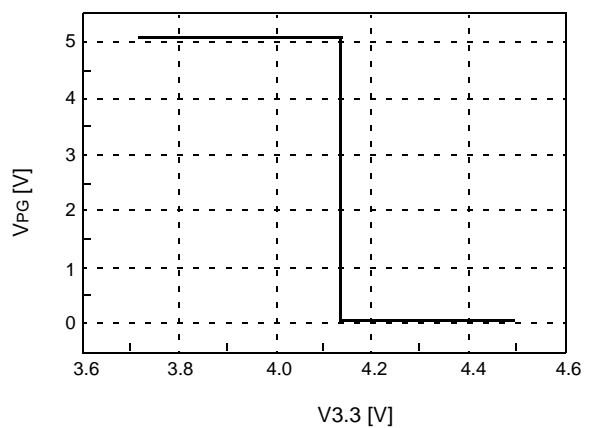

OVP for 5V

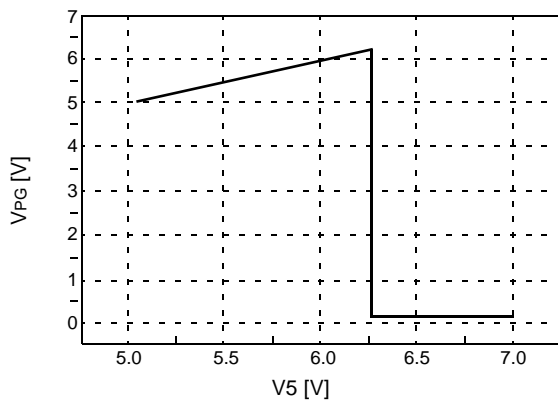

OVP for 12V

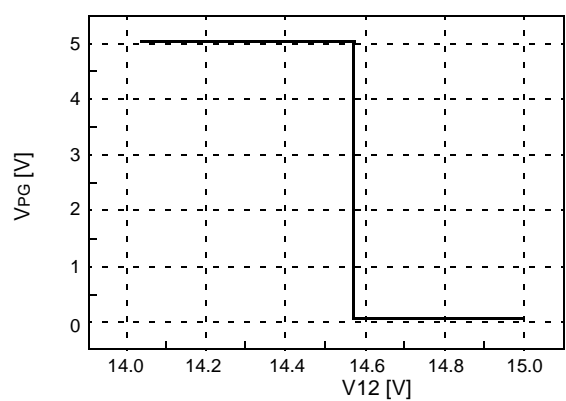

OVP for PT

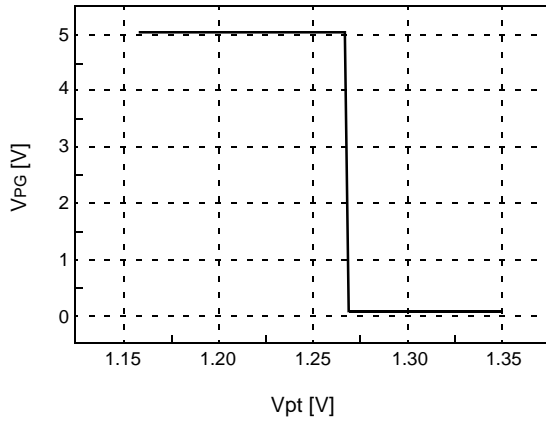

UVP for 3.3V

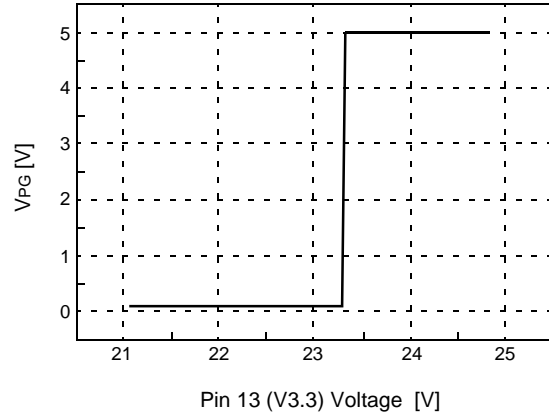

UVP for 5V

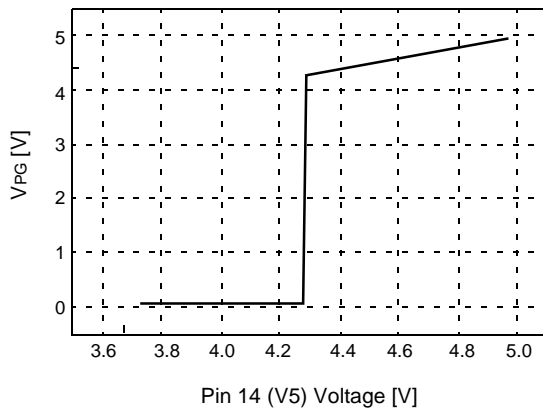

UVP for 12V

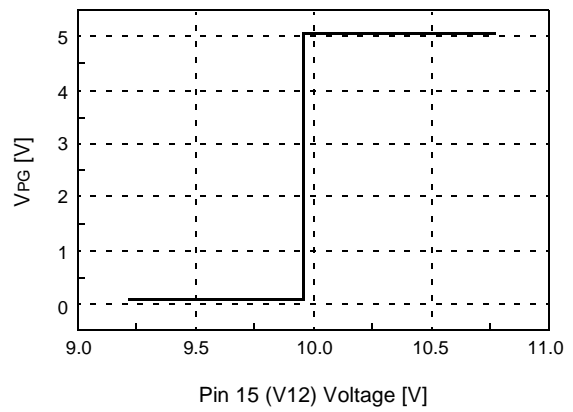

Remote ON Charging Current

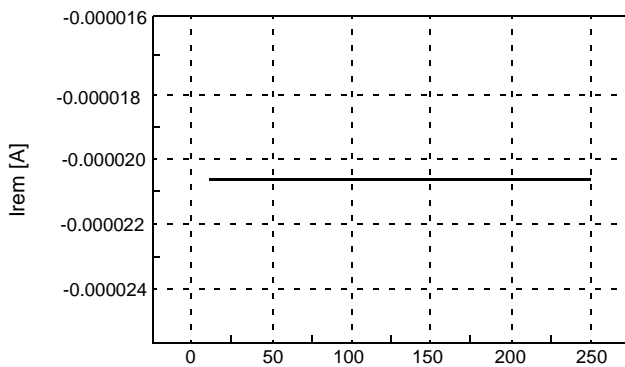

REM ON/OFF Vth

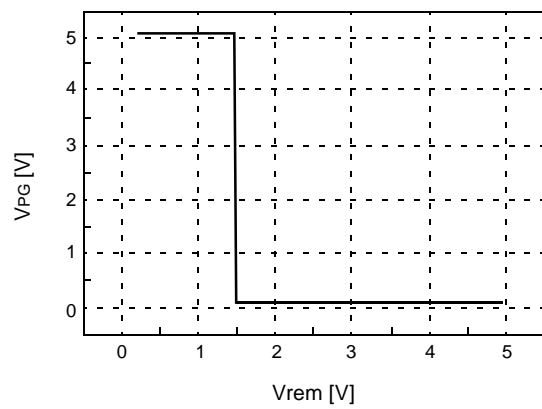

Remote ON Open Voltage

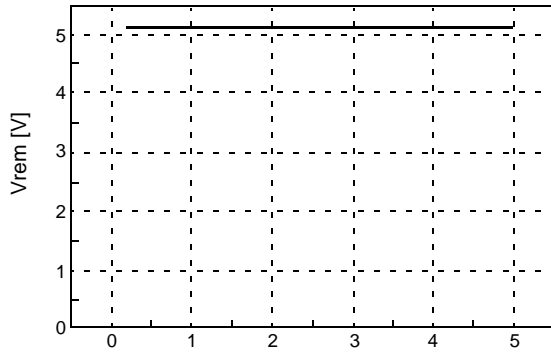

Detecting V<sub>CC</sub> Voltage (DET)

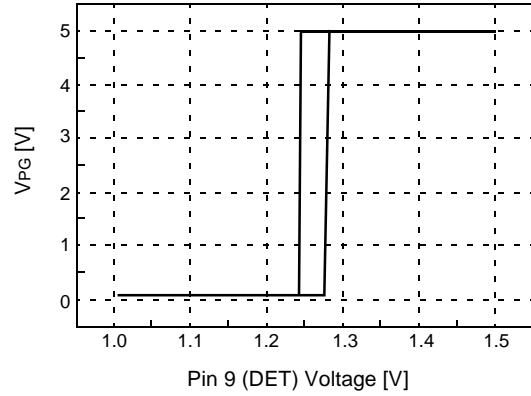

Detecting V5 Voltage

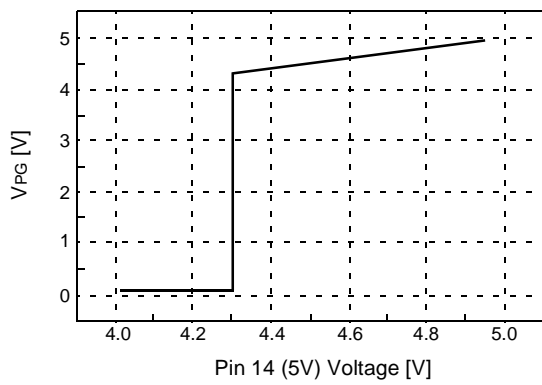

Charging Current for PG

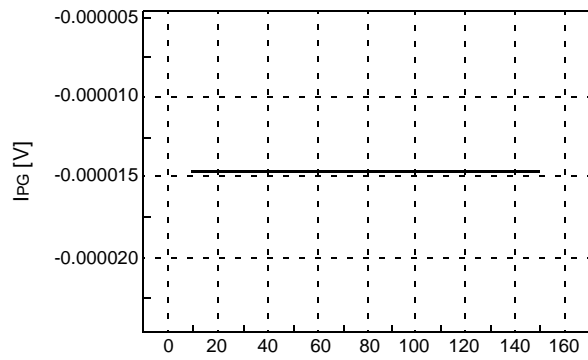

Short Circuit Current

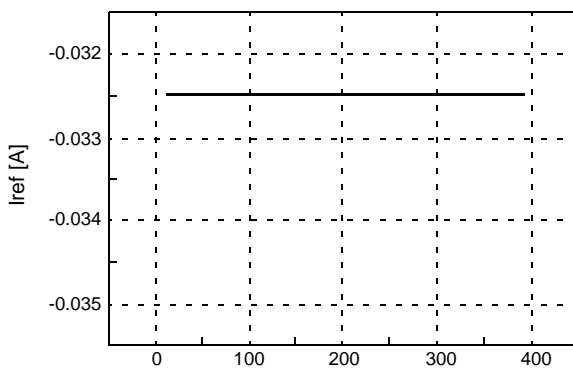

Hysteresis Voltage 2

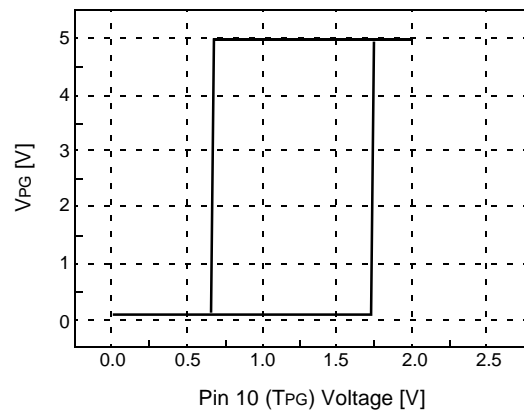

Error Amp Sink Current

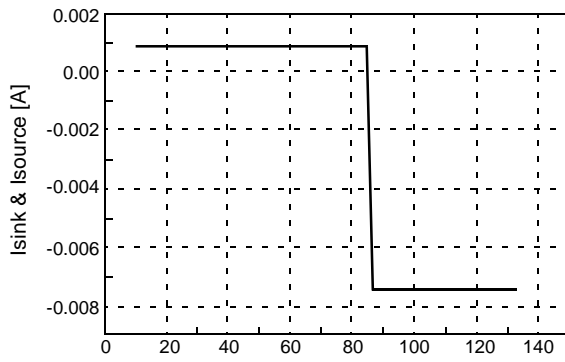

Reference Voltage

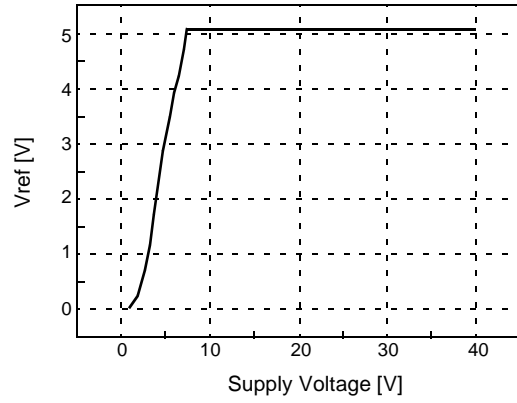

EXPERIMENTAL RESULT

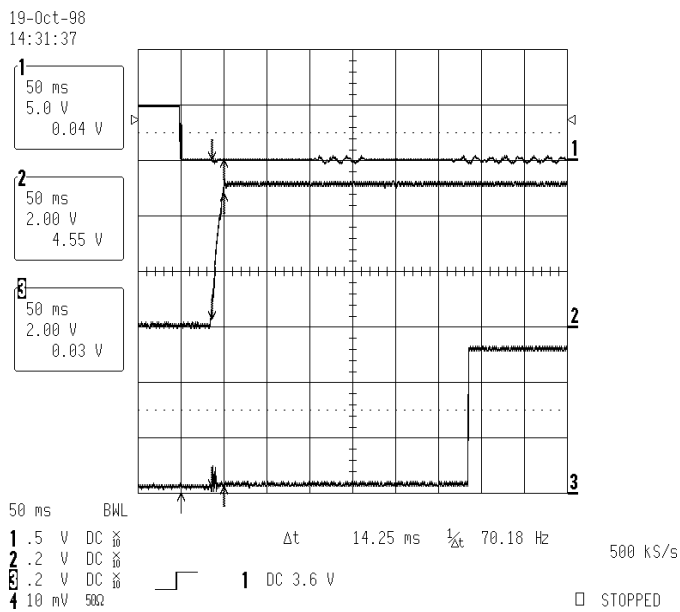

CH1 : PS-ON

CH2 : +5Vdc Output

CH3 : PG Signal

Figure 3. Rising Time of +5Vdc Output Voltage

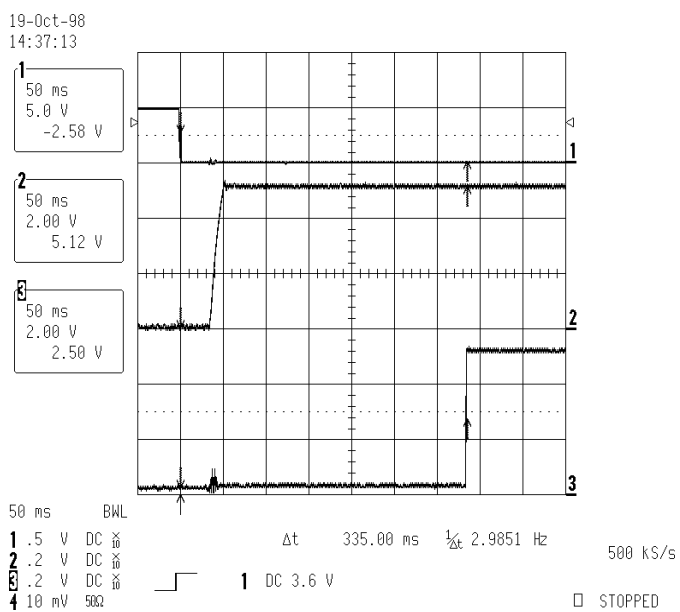

CH1 : PS-ON

CH2 : +5Vdc Output

CH3 : PG Signal

Figure 4. PG Signal Delay Time

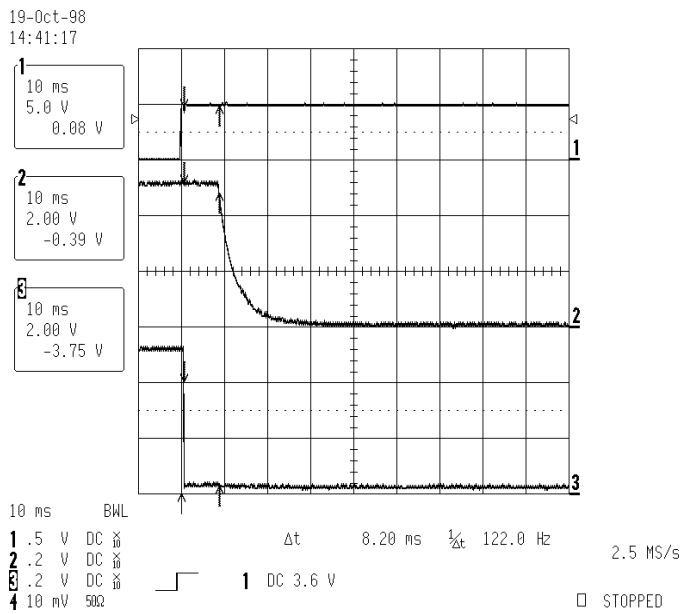

CH1 : PS-ON

CH2 : +5Vdc Output

CH3 : PG Signal

Figure 5. Power Down Warning

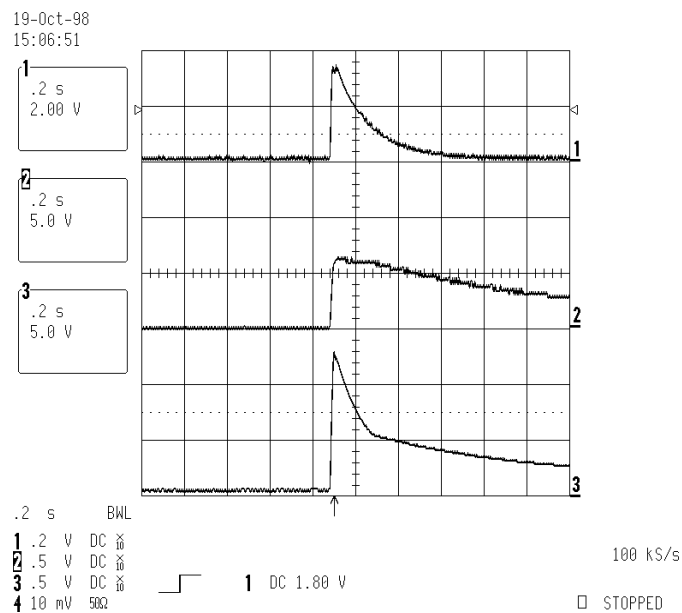

CH1 : +3.3Vdc Output

CH2 : +5Vdc Output

CH3 : +12Vdc Output

Figure 6. No Load Protection



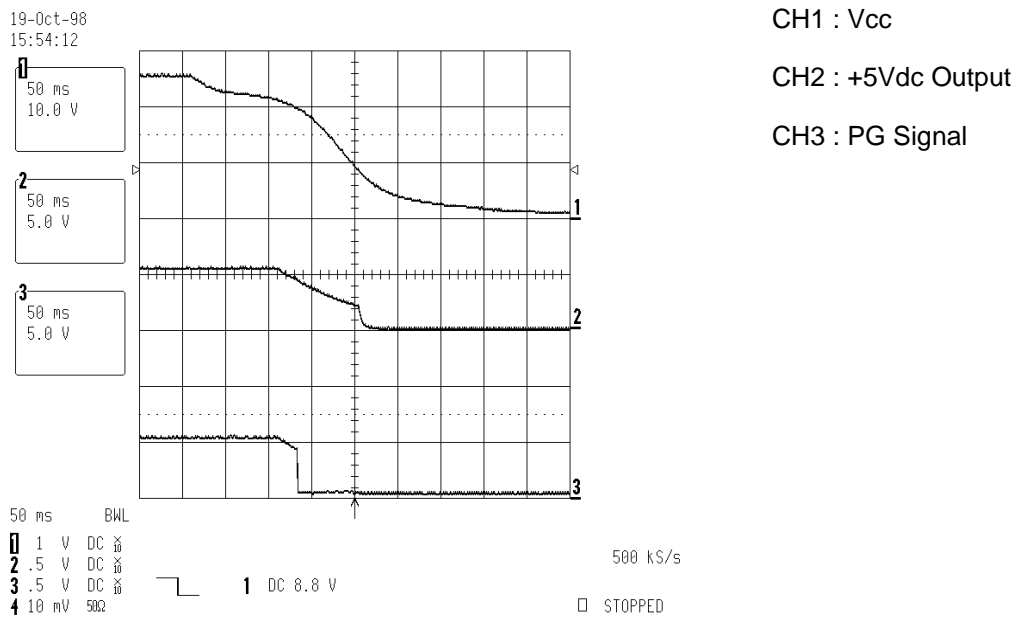

Figure 7. Vcc, +5Vdc Output vs. PG Signal (High)

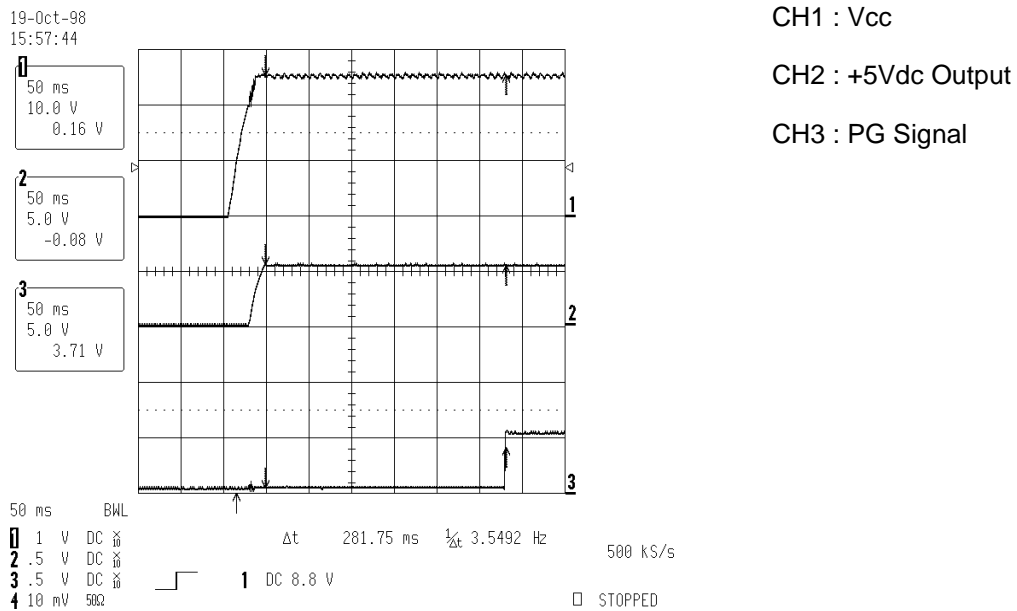
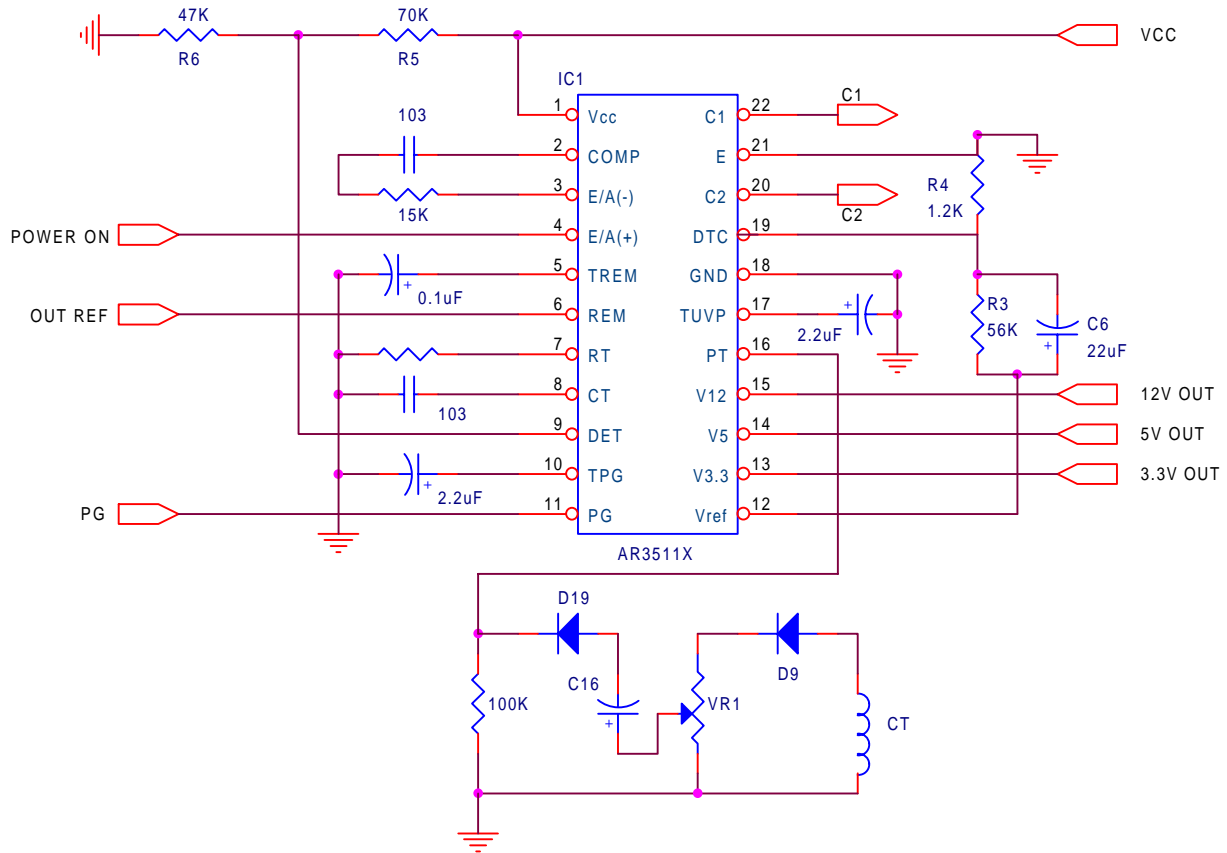

Figure 8. Vcc, +5Vdc Output vs. PG Signal (Low)

APPLICATION CIRCUIT



PACKAGE DIMENSION

**22-DIP-400**

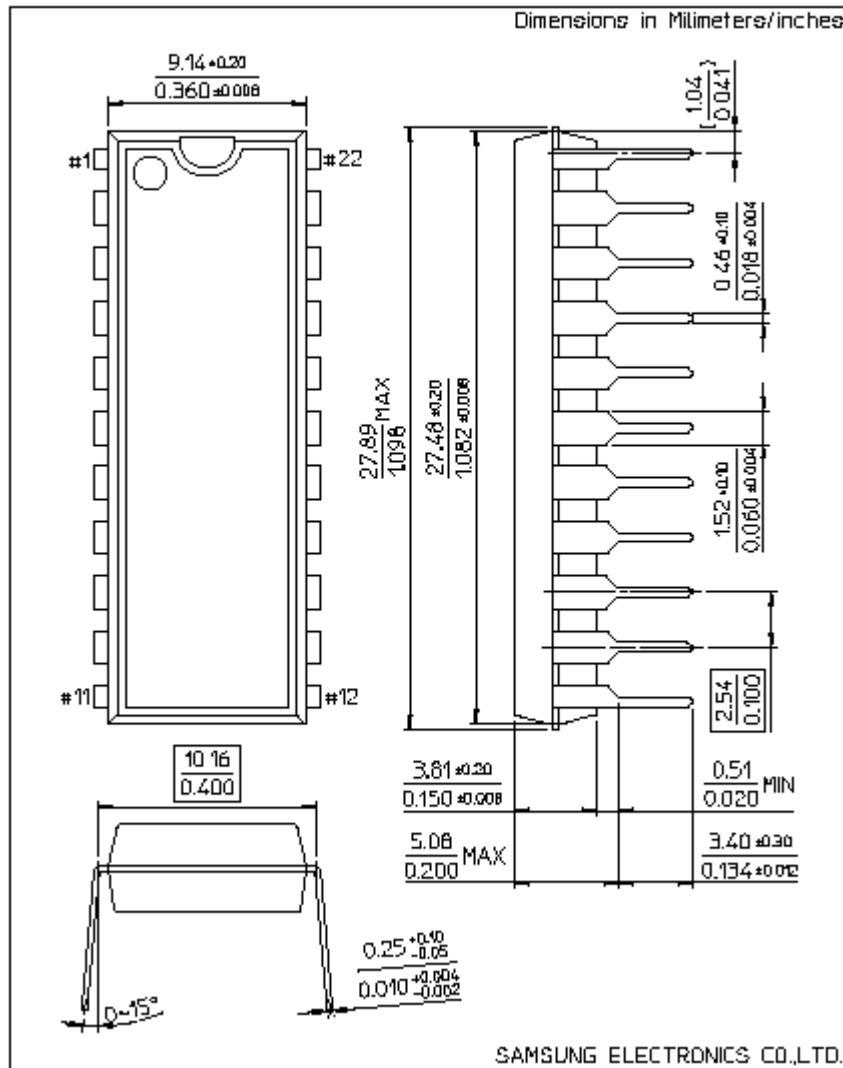

PACKAGE DIMENSION

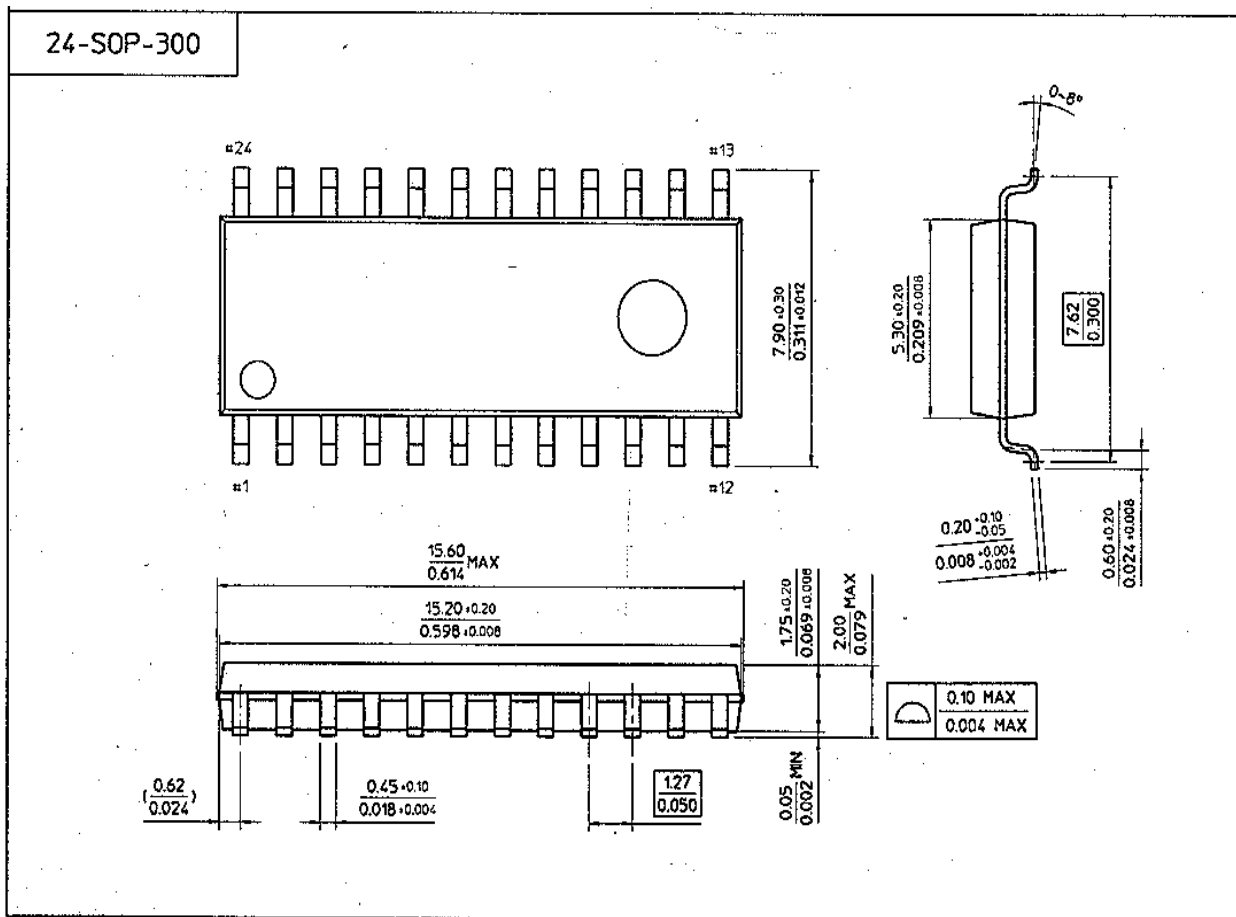

---

## **LIFE SUPPORT POLICY**

FAIRCHILD'S PRODUCTS ARE NOT AUTHORIZED FOR USE AS CRITICAL COMPONENTS IN LIFE SUPPORT DEVICES OR SYSTEMS WITHOUT THE EXPRESS WRITTEN APPROVAL OF THE PRESIDENT OF FAIRCHILD SEMICONDUCTOR CORPORATION. As used herein:

1. Life support devices or systems are devices or systems which, (a) are intended for surgical implant into the body, or (b) support or sustain life, and (c) whose failure to perform when properly used in accordance with instructions for use provided in the labeling, can be reasonably expected to result in a significant injury of the user.
2. A critical component in any component of a life support device or system whose failure to perform can be reasonably expected to cause the failure of the life support device or system, or to affect its safety or effectiveness.