

KA5M0965Q

Fairchild Power Switch(FPS)

Features

- Precision Fixed Operating Frequency (70kHz)
- Low Start-up Current(Typ. 100uA)
- Pulse by Pulse Current Limiting
- Over Load Protection
- Over Current Protection
- Over Voltage Protection (Min. 25V)
- Internal Thermal Shutdown Function
- Under Voltage Lockout
- Internal High Voltage Sense FET
- Latch Mode

Description

The Fairchild Power Switch(FPS) product family is specially designed for an off-line SMPS with minimal external components. The Fairchild Power Switch(FPS) consist of high voltage power SenseFET and current mode PWM IC. Included PWM controller features integrated fixed frequency oscillator, under voltage lock-out, leading edge blanking, optimized gate turn-on/turn-off driver, thermal shutdown protection, over voltage protection, and temperature compensated precision current sources for loop compensation and fault protection circuitry. compared to discrete MOSFET and PWM controller or RCC solution, a Fairchild Power Switch(FPS) can reduce total component count, design size, weight and at the same time increase efficiency, productivity, and system reliability. It has a basic platform well suited for cost effective design in either a flyback converter or a forward converter.

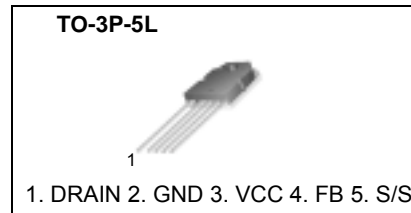

Internal Block Diagram

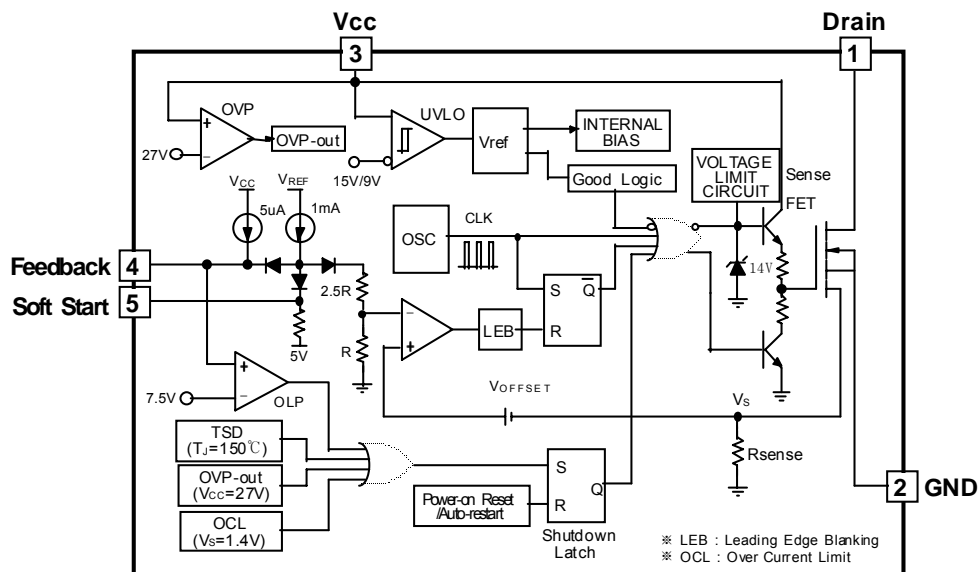

Absolute Maximum Ratings

Characteristic	Symbol	Value	Unit
Drain-Gate Voltage (RGS=1M Ω)	VDGR	650	V
Gate-Source (GND) Voltage	VGS	\pm 30	V
Drain Current Pulsed ⁽²⁾	IDM	36.0	ADC
Single Pulsed Avalanche Energy ⁽³⁾	EAS	950	mJ
Continuous Drain Current (TC=25°C)	ID	9.0	ADC
Continuous Drain Current (TC=100°C)	ID	5.8	ADC
Maximum Supply Voltage	VCC,MAX	30	V
Input Voltage Range	VFB	-0.3 to VSD	V
Total Power Dissipation	PD (watt H/S)	170	W
	Darting	1.33	W/°C
Operating Ambient Temperature	TA	-25 to +85	°C
Storage Temperature	TSTG	-55 to +150	°C

Note:

1. T_j = 25°C to 150°C
2. Repetitive rating: Pulse width limited by maximum junction temperature
3. L = 20mH, V_{DD} = 50V, R_G = 27 Ω , starting T_j = 25°C

Electrical Characteristics (SFET Part)

(Ta = 25°C unless otherwise specified)

Characteristic	Symbol	Test condition	Min.	Typ.	Max.	Unit
Drain-Source Breakdown Voltage	BVDSS	VGS=0V, ID=50μA	650	-	-	V
Zero Gate Voltage Drain Current	IDSS	VDS=Max., Rating, VGS=0V	-	-	50	μA
		VDS=0.8Max., Rating, VGS=0V, TC=125°C	-	-	200	mA
Static Drain-Source on Resistance ^(Note)	RDS(ON)	VGS=10V, ID=4.5A	-	0.96	1.2	W
Forward Transconductance ^(Note)	gfs	VDS=50V, ID=4.5A	5.0	-	-	S
Input Capacitance	Ciss	VGS=0V, VDS=25V, f=1MHz	-	1200	-	pF
Output Capacitance	Coss		-	135	-	
Reverse Transfer Capacitance	Crss		-	25	-	
Turn on Delay Time	td(on)		VDD=0.5BVDSS, ID=9.0A (MOSFET switching time are essentially independent of operating temperature)	-	25	
Rise Time	tr	-		75	160	
Turn Off Delay Time	td(off)	-		130	270	
Fall Time	tf	-		70	150	
Total Gate Charge (Gate-Source+Gate-Drain)	Qg	VGS=10V, ID=9.0A, VDS=0.8BVDSS	-	45	60	nC
Gate-Source Charge	Qgs		-	8	-	
Gate-Drain (Miller) Charge	Qgd		-	22	-	

Note:

1. Pulse test: Pulse width ≤ 300μS, duty ≤ 2%
2. $S = \frac{1}{R}$

Electrical Characteristics (Control Part) (Continued)

(Ta = 25°C unless otherwise specified)

Characteristic	Symbol	Test condition	Min.	Typ.	Max.	Unit
UVLO SECTION						
Start Threshold Voltage	VSTART	-	14	15	16	V
Stop Threshold Voltage	VSTOP	After turn on	8.4	9	9.6	V
OSCILLATOR SECTION						
Initial Accuracy	FOSC	Ta=25°C	61	67	73	kHz
Frequency Change With Temperature ⁽²⁾	-	-25°C ≤ Ta ≤ +85°C	-	±5	±10	%
Maximum Duty Cycle	Dmax	-	74	77	80	%
FEEDBACK SECTION						
Feedback Source Current	IFB	Ta=25°C, 0V ≤ Vfb ≤ 3V	0.7	0.9	1.1	mA
Shutdown Feedback Voltage	VSD	Vfb ≥ 6.5V	6.9	7.5	8.1	V
Shutdown Delay Current	Idelay	Ta=25°C, 5V ≤ Vfb ≤ VSD	4	5	6	μA
SOFT START SECTION						
Soft Start Voltage	VSS	VFB = 2V	4.7	5.0	5.3	V
Soft Start Current	ISS	Sync & S/S=GND	0.8	1.0	1.2	mA
CURRENT LIMIT(SELF-PROTECTION)SECTION						
Peak Current Limit	IOVER	Max. inductor current	5.28	6.00	6.72	A
PROTECTION SECTION						
Thermal Shutdown Temperature (Tj) ⁽¹⁾	TSD	-	140	160	-	°C
Over Voltage Protection Voltage	VOVP	VCC ≥ 24V	25	27	29	V
TOTAL DEVICE SECTION						
Start-up Current	ISTART	VCC=14V	-	0.1	0.17	mA
Operating Supply Current (Control Part Only)	IOP	VCC ≤ 28	-	7	12	mA

Note:

1. These parameters, although guaranteed, are not 100% tested in production
2. These parameters, although guaranteed, are tested in EDS(water test) process
3. These parameters are indicated Inductor current.

Typical Performance Characteristics

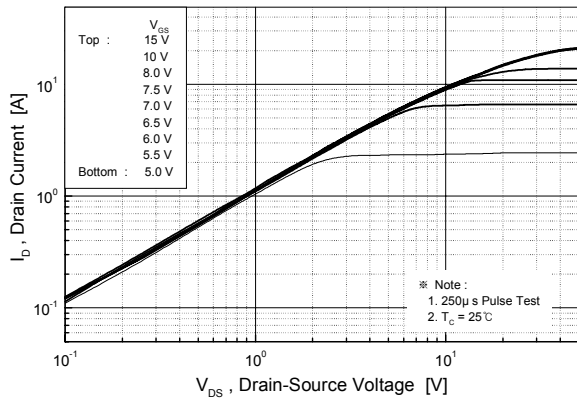

Figure 1. Output Characteristics

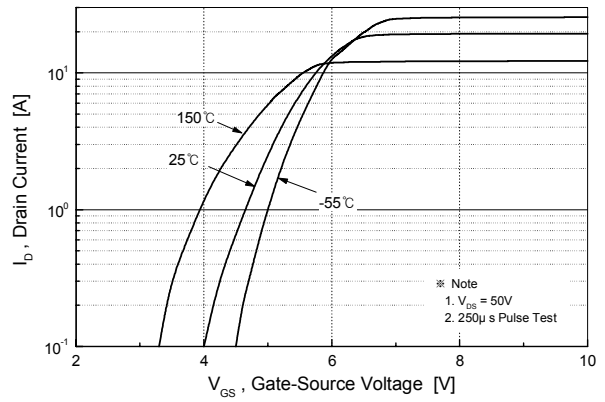

Figure 2. Transfer Characteristics

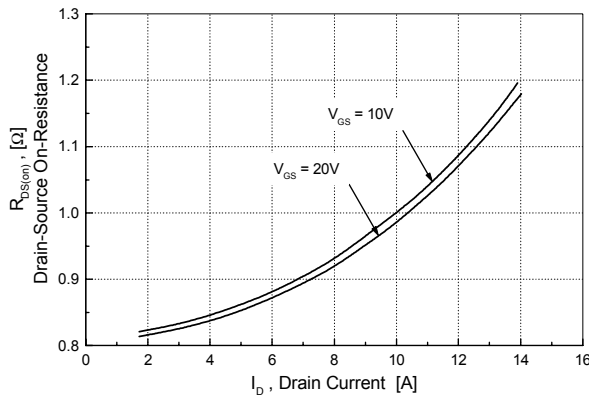

Figure 3. On-Resistance vs. Drain Current

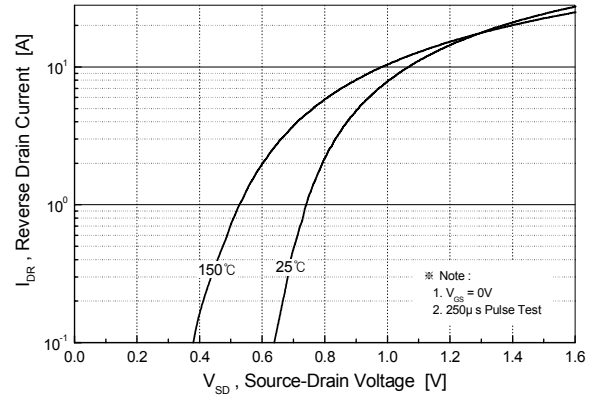

Figure 4. Source-Drain Diode Forward Voltage

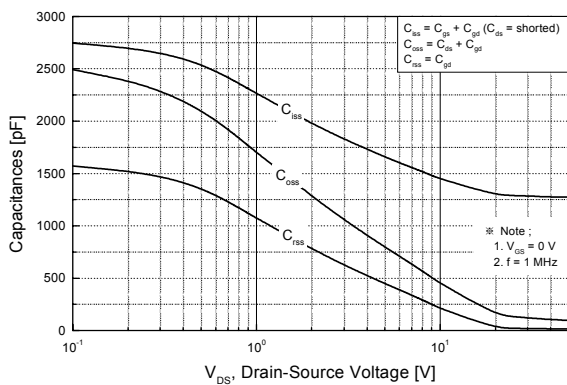

Figure 5. Capacitance vs. Drain-Source Voltage

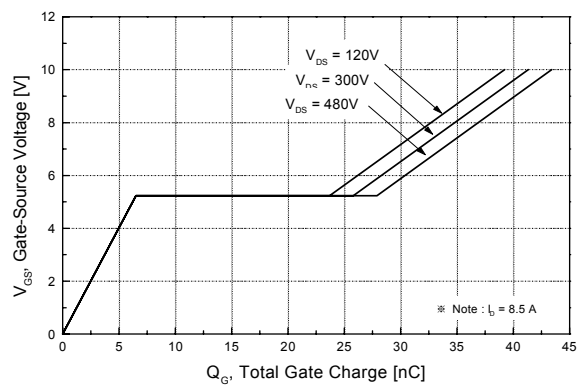

Figure 6. Gate Charge vs. Gate-Source Voltage

Typical Performance Characteristics (Continued)

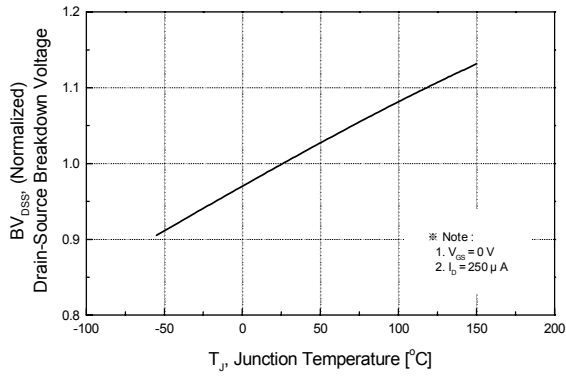

Figure 7. Breakdown Voltage vs. Temperature

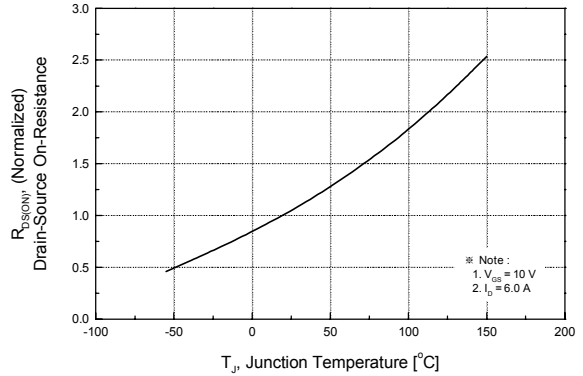

Figure 8. On-Resistance vs. Temperature

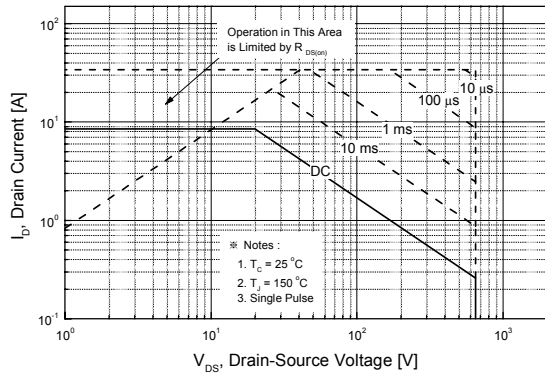

Figure 9. Max. Safe Operating Area

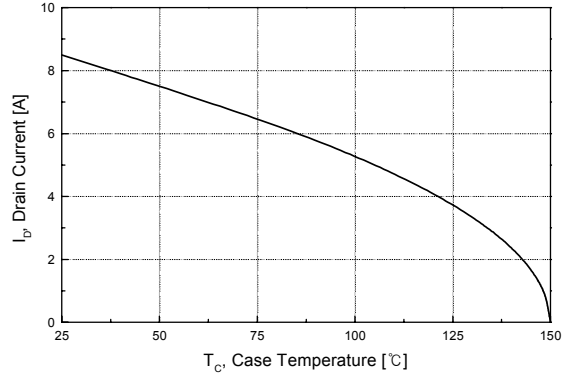

Figure 10. Max. Drain Current vs. Case Temperature

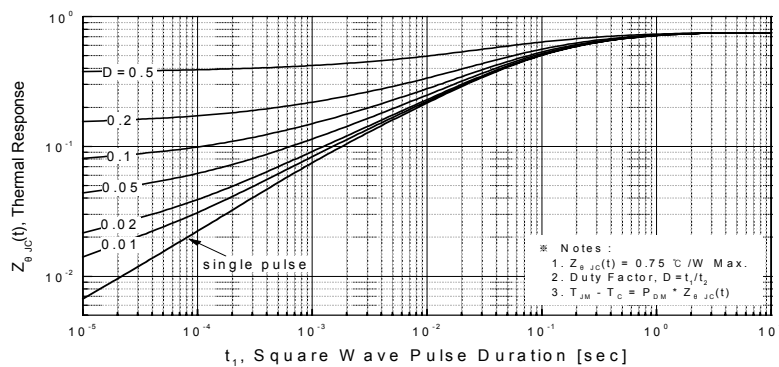

Figure 11. Thermal Response

Typical Performance Characteristics (Control part) (Continued)

(These characteristic graphs are normalized at $T_a = 25^\circ\text{C}$)

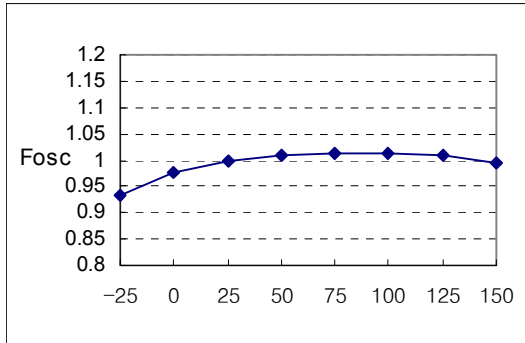

Figure 1. Operating Frequency

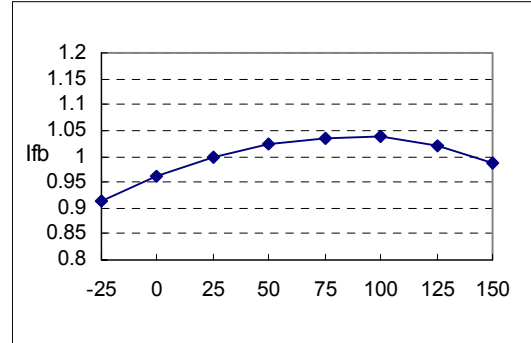

Figure 2. Feedback Source Current

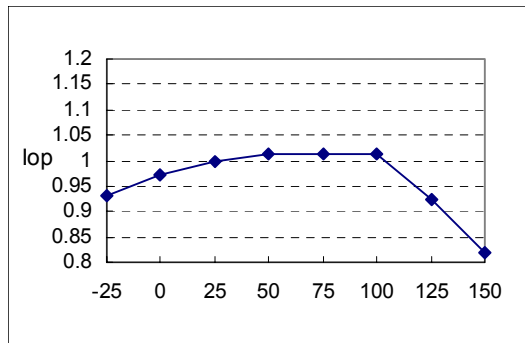

Figure 3. Operating Supply Current

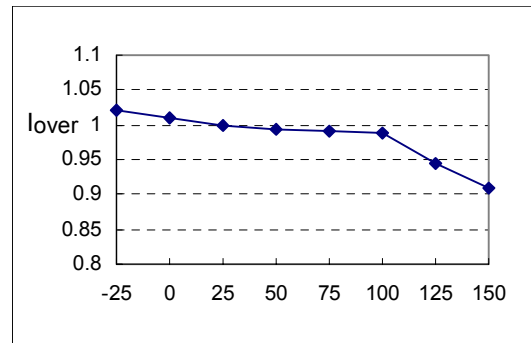

Figure 4. Peak Current Limit

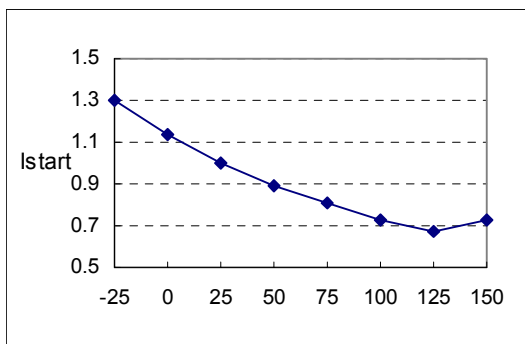

Figure 5. Start up Current

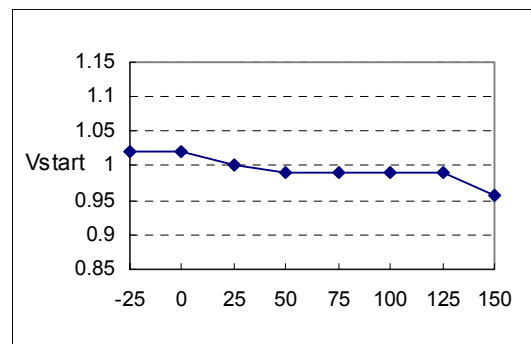

Figure 6. Start Threshold Voltage

Typical Performance Characteristics (Continued)

(These characteristic graphs are normalized at $T_a = 25^\circ\text{C}$)

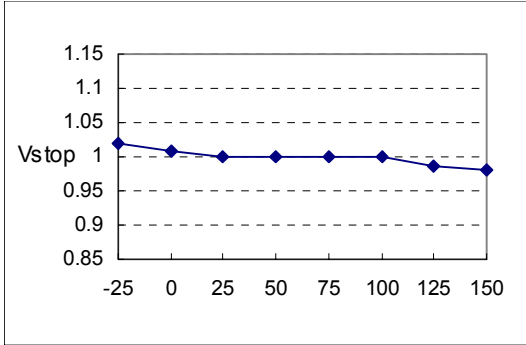

Figure 7. Stop Threshold Voltage

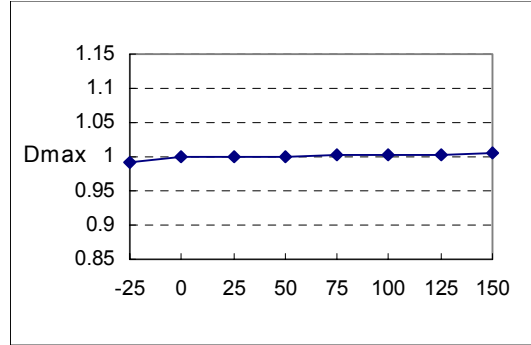

Figure 8. Maximum Duty Cycle

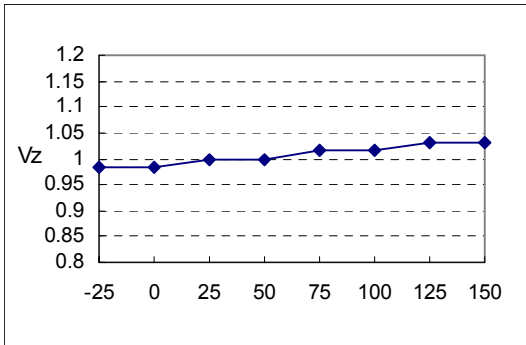

Figure 9. VCC Zener Voltage

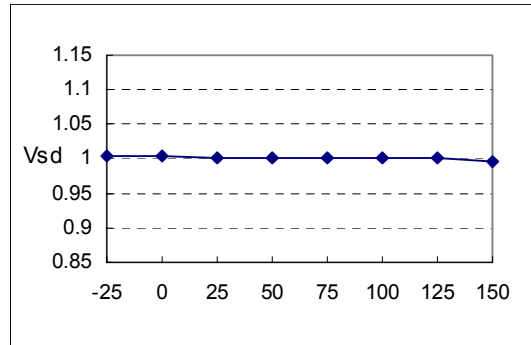

Figure 10. Shutdown Feedback Voltage

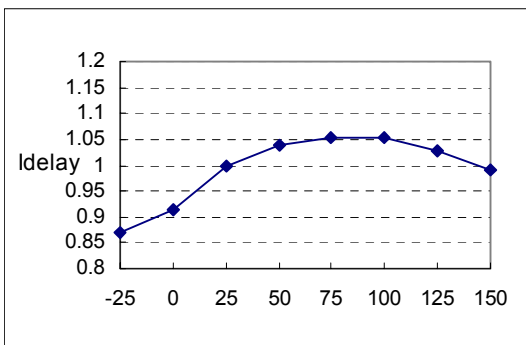

Figure 11. Shutdown Delay Current

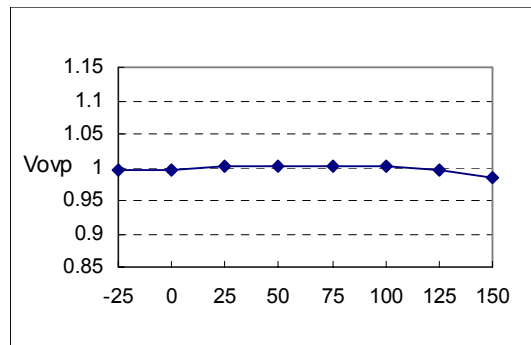

Figure 12. Over Voltage Protection

Typical Performance Characteristics (Continued)

(These characteristic graphs are normalized at $T_a = 25^\circ\text{C}$)

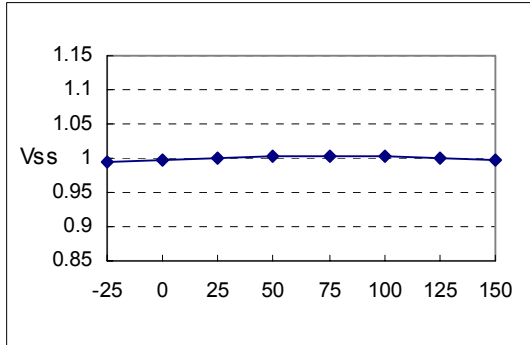

Figure 13. Soft Start Voltage

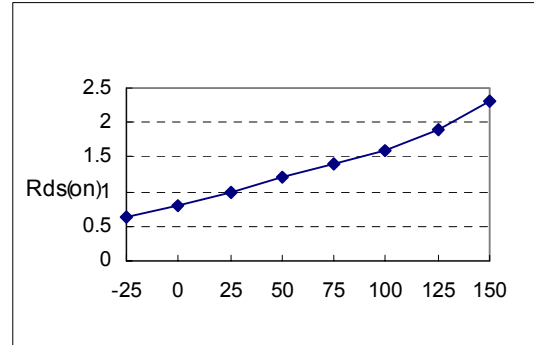

Figure 14. Static Drain-Source on Resistance

Ordering Information

Product Number	Package	Rating	Operating Temperature
KA5M0965QTU	TO-3P-5L	650V, 9A	-25°C to +85°C
KA5M0965QYDTU	TO-3P-5L(Forming)		

TU : Non Forming Type

YDTU : Forming Type

DISCLAIMER

FAIRCHILD SEMICONDUCTOR RESERVES THE RIGHT TO MAKE CHANGES WITHOUT FURTHER NOTICE TO ANY PRODUCTS HEREIN TO IMPROVE RELIABILITY, FUNCTION OR DESIGN. FAIRCHILD DOES NOT ASSUME ANY LIABILITY ARISING OUT OF THE APPLICATION OR USE OF ANY PRODUCT OR CIRCUIT DESCRIBED HEREIN; NEITHER DOES IT CONVEY ANY LICENSE UNDER ITS PATENT RIGHTS, NOR THE RIGHTS OF OTHERS.

LIFE SUPPORT POLICY

FAIRCHILD'S PRODUCTS ARE NOT AUTHORIZED FOR USE AS CRITICAL COMPONENTS IN LIFE SUPPORT DEVICES OR SYSTEMS WITHOUT THE EXPRESS WRITTEN APPROVAL OF THE PRESIDENT OF FAIRCHILD SEMICONDUCTOR CORPORATION. As used herein:

1. Life support devices or systems are devices or systems which, (a) are intended for surgical implant into the body, or (b) support or sustain life, and (c) whose failure to perform when properly used in accordance with instructions for use provided in the labeling, can be reasonably expected to result in a significant injury of the user.
2. A critical component in any component of a life support device or system whose failure to perform can be reasonably expected to cause the failure of the life support device or system, or to affect its safety or effectiveness.