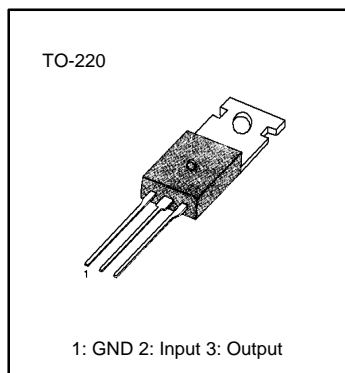

3-TERMINAL 1A NEGATIVE VOLTAGE REGULATORS

The MC79XX series of three-terminal negative regulators are available in TO-220 package and with several fixed output voltages, making them useful in a wide range of applications. Each type employs internal current limiting, thermal shut-down and safe area protection, making it essentially indestructible.

FEATURES

- Output Current in Excess of 1A
- Output Voltages of -5, -6, -8, -12, -15, -18, -24V
- Internal Thermal Overload Protection
- Short Circuit Protection
- Output Transistor Safe-Area Compensation

**ORDERING INFORMATION**

Device	Output Voltage Tolerance	Package	Operating Temperature
MC79XXCT (LM79XXCT) (KA79XX)	± 4%	TO-220	0 ~+125°C
KA79XXA	± 2%		

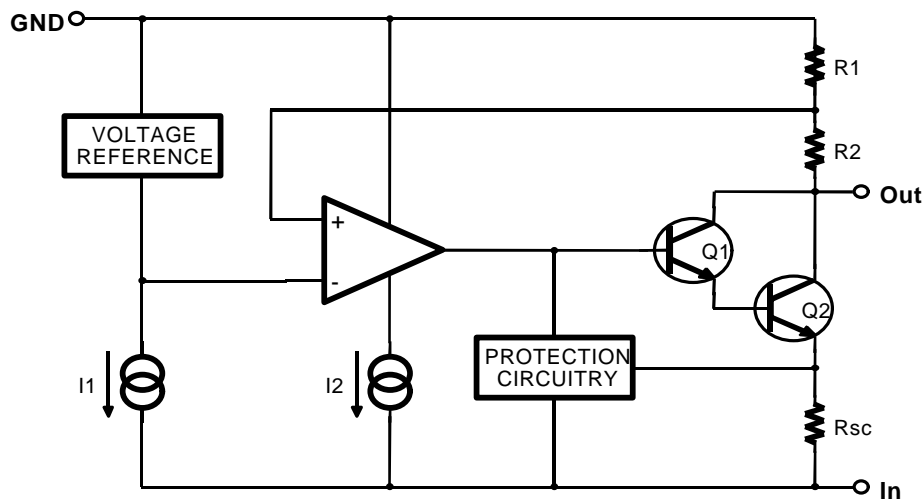
BLOCK DIAGRAM

ABSOLUTE MAXIMUM RATINGS ($T_A=+25^{\circ}\text{C}$, unless otherwise specified)

Characteristic	Symbol	Value	Unit
Input Voltage	V_I	-35	V
Thermal Resistance Junction-Cases	$R_{\theta JC}$	5	$^{\circ}\text{C}/\text{W}$
Junction-Air	$R_{\theta JA}$	65	$^{\circ}\text{C}/\text{W}$
Operating Temperature Range	T_{OPR}	0 ~ +125	$^{\circ}\text{C}$
Storage Temperature Range	T_{STG}	- 65 ~ +150	$^{\circ}\text{C}$

LM7905 ELECTRICAL CHARACTERISTICS

($V_I = 10\text{V}$, $I_O = 500\text{mA}$, $0^{\circ}\text{C} \leq T_J \leq +125^{\circ}\text{C}$, $C_I = 2.2\mu\text{F}$, $C_O = 1\mu\text{F}$, unless otherwise specified.)

Characteristic	Symbol	Test Conditions	Min	Typ	Max	Unit
Output Voltage	V_O	$T_J = +25^{\circ}\text{C}$	- 4.8	- 5.0	- 5.2	V
		$I_O = 5\text{mA}$ to 1A, $P_O = 15\text{W}$ $V_I = -7$ to -20V	- 4.75	-5.0	- 5.25	
Line Regulation	ΔV_O	$T_J = +25^{\circ}\text{C}$ $V_I = -7$ to -20V $I_O = 1\text{A}$		5	50	mV
		$V_I = -8$ to -12V $I_O = 1\text{A}$		2	25	
		$V_I = -7.5$ to -25V		7	50	
		$V_I = -8$ to -12V $I_O = 1\text{A}$		7	50	
Load Regulation	ΔV_O	$I_O = 5\text{mA}$ to 1.5A		10	100	mV
		$T_J = +25^{\circ}\text{C}$ $I_O = 250$ to 750mA		3	50	
Quiescent Current	I_Q	$T_J = +25^{\circ}\text{C}$		3	6	mA
Quiescent Current Change	ΔI_Q	$I_O = 5\text{mA}$ to 1A		0.05	0.5	mA
		$V_I = -8$ to -25V		0.1	0.8	
Temperature Coefficient of V_D	$\Delta V_O/\Delta T$	$I_O = 5\text{mA}$		- 0.4		mV/ $^{\circ}\text{C}$
Output Noise Voltage	V_N	$f = 10\text{Hz}$ to 100KHz $T_A = +25^{\circ}\text{C}$		40		μV
Ripple Rejection	RR	$f = 120\text{Hz}$, $I_O = -35\text{V}$ $\Delta V_I = 10\text{V}$	54	60		dB
Dropout Voltage	V_D	$T_J = +25^{\circ}\text{C}$ $I_O = 1\text{A}$		2		V
Short Circuit Current	I_{SC}	$T_J = +25^{\circ}\text{C}$, $V_I = -35\text{V}$		300		mA
Peak Current	I_{PK}	$T_J = +25^{\circ}\text{C}$		2.2		A

* Load and line regulation are specified at constant junction temperature. Changes in V_O due to heating effects must be taken into account separately. Pulse testing with low duty is used.

LM7906 ELECTRICAL CHARACTERISTICS(V_I = 11V, I_O = 500mA, 0°C ≤ T_J ≤ +125°C, C_I = 2.2μF, C_O = 1μF, unless otherwise specified.)

Characteristic	Symbol	Test Conditions	Min	Typ	Max	Unit
Output Voltage	V _O	T _J = +25°C	- 5.75	- 6	- 6.25	V
		I _O = 5mA to 1A, P _O = 15W V _I = - 9 to - 21V	- 5.7	- 6	- 6.3	
Line Regulation	ΔV _O	T _J = 25°C	V _I = - 8 to - 25V	10	120	mV
			V _I = - 9 to - 12V	5	60	
Load Regulation	ΔV _O	T _J = + 25°C I _O = 5mA to 1.5A		10	120	mV
		T _J = + 25°C I _O = 250 to 750mA		3	60	
Quiescent Current	I _O	T _J = + 25°C		3	6	mA
Quiescent Current Change	ΔI _O	I _O = 5mA to 1A			0.5	mA
		V _I = - 9 to - 25V			1.3	
Temperature Coefficient of V _O	ΔV _O /ΔT	I _O = 5mA		-0.5		mV/°C
Output Noise Voltage	V _N	f = 10Hz to 100KHz T _A = + 25°C		130		μV
Ripple Rejection	RR	f = 120Hz ΔV _I = 10V	54	60		dB
Dropout Voltage	V _D	T _J = + 25°C I _O = 1A		2		V
Short Circuit Current	I _{SC}	T _J = +25°C, V _I = -35V		300		mA
Peak Current	I _{PK}	T _J = +25°C		2.2		A

* Load and line regulation are specified at constant junction temperature. Changes in V_O due to heating effects must be taken into account separately. Pulse testing with low duty is used.

LM7908 ELECTRICAL CHARACTERISTICS(V_I = 14V, I_O = 500mA, 0°C ≤ T_J ≤ +125°C, C_I = 2.2μF, C_O = 1μF, unless otherwise specified.)

Characteristic	Symbol	Test Conditions	Min	Typ	Max	Unit
Output Voltage	V _O	T _J = +25°C	-7.7	-8	-8.3	V
		I _O = 5mA to 1A, P _O = 15W V _I = -1.5 to -23V	-7.6	-8	-8.4	
Line Regulation	ΔV _O	T _J = 25°C		10	100	mV
		V _I = -10.5 to -25V V _I = -11 to -17V		5	80	
Load Regulation	ΔV _O	T _J = +25°C I _O = 5mA to 1.5A		12	160	mV
		T _J = +25°C I _O = 250 to 750mA		4	80	
Quiescent Current	I _Q	T _J = +25°C		3	6	mA
Quiescent Current Change	ΔI _Q	I _O = 5mA to 1A		0.05	0.5	mA
		V _I = -11.5 to -25V		0.1	1	
Temperature Coefficient of V _O	ΔV _O /ΔT	I _O = 5mA		-0.6		mV/°C
Output Noise Voltage	V _N	f = 10Hz to 100KHz T _A = +25°C		175		μV
Ripple Rejection	RR	f = 120Hz ΔV _I = 10V	54	60		dB
Dropout Voltage	V _D	T _J = +25°C I _O = 1A		2		V
Short Circuit Current	I _{SC}	T _J = +25°C, V _I = -35V		300		mA
Peak Current	I _{PK}	T _J = +25°C		2.2		A

* Load and line regulation are specified at constant junction temperature. Changes in V_O due to heating effects must be taken into account separately. Pulse testing with low duty is used.

LM7909 ELECTRICAL CHARACTERISTICS(V_I = 14V, I_O = 500mA, 0°C ≤ T_J ≤ +125°C, C_I = 2.2μF, C_O = 1μF, unless otherwise specified)

Characteristic	Symbol	Test Conditions	Min	Typ	Max	Unit
Output Voltage	V _O	T _J = +25°C	-8.7	-9.0	-9.3	V
		I _O = 5mA to 1A, P _O = 15W V _I = -1.5 to -23V	-8.6	-9.0	-9.4	
Line Regulation	ΔV _O	T _J = 25°C	V _I = -10.5 to -25V	10	180	mV
			V _I = -11 to -17V	5	90	
Load Regulation	ΔV _O	T _J = +25°C I _O = 5mA to 1.5A		12	180	mV
		T _J = +25°C I _O = 250 to 750mA		4	90	
Quiescent Current	I _Q	T _J = +25°C		3	6	mA
Quiescent Current Change	ΔI _Q	I _O = 5mA to 1A		0.05	0.5	mA
		V _I = -11.5 to -25V		0.1	1	
Temperature Coefficient of V _O	ΔV _O /ΔT	I _O = 5mA		-0.6		mV/°C
Output Noise Voltage	V _N	f = 10Hz to 100KHz T _A = +25°C		175		μV
Ripple Rejection	RR	f = 120Hz ΔV _I = 10V	54	60		dB
Dropout Voltage	V _D	T _J = +25°C I _O = 1A		2		V
Short Circuit Current	I _{SC}	T _J = +25°C, V _I = -35V		300		mA
Peak Current	I _{PK}	T _J = +25°C		2.2		A

* Load and line regulation are specified at constant junction temperature. Changes in V_O due to heating effects must be taken into account separately. Pulse testing with low duty is used.

LM7912 ELECTRICAL CHARACTERISTICS(V_I = 18V, I_O = 500mA, 0°C ≤ T_J ≤ +125°C, C_I = 2.2μF, C_O = 1μF, unless otherwise specified.)

Characteristic	Symbol	Test Conditions	Min	Typ	Max	Unit	
Output Voltage	V _O	T _J = +25°C	-11.5	-12	-12.5	V	
		I _O = 5mA to 1A, P _O = 15W V _I = -15.5 to -27V	-11.4	-12	-12.6		
Line Regulation	ΔV _O	T _J = 25°C	V _I = -14.5 to -30V		12	240	mV
			V _I = -16 to -22V		6	120	
Load Regulation	ΔV _O	T _J = +25°C		12	240	mV	
		I _O = 5mA to 1.5A					
Quiescent Current	I _Q	T _J = +25°C		3	6	mA	
			I _O = 5mA to 1A		0.05		0.5
Quiescent Current Change	ΔI _Q	T _J = +25°C	V _I = -15 to -30V		0.1	1	mA
Temperature Coefficient of V _O	ΔV _O /ΔT	I _O = 5mA		-0.8		mV/°C	
Output Noise Voltage	V _N	f = 10Hz to 100KHz T _A = +25°C		200		μV	
Ripple Rejection	RR	f = 120Hz ΔV _I = 10V	54	60		dB	
Dropout Voltage	V _D	T _J = +25°C I _O = 1A		2		V	
Short Circuit Current	I _{SC}	T _J = +25°C, V _I = -35V		300		mA	
Peak Current	I _{PK}	T _J = +25°C		2.2		A	

* Load and line regulation are specified at constant junction temperature. Changes in V_O due to heating effects must be taken into account separately. Pulse testing with low duty is used.

LM7915 ELECTRICAL CHARACTERISTICS(V_I = 23V, I_O = 500mA, 0°C ≤ T_J ≤ +125°C, C_I = 2.2μF, C_O = 1μF, unless otherwise specified.)

Characteristic	Symbol	Test Conditions	Min	Typ	Max	Unit
Output Voltage	V _O	T _J = +25°C	-14.4	-15	-15.6	V
		I _O = 5mA to 1A, P _O = 15W V _I = -18 to -30V	-14.25	-15	-15.75	
Line Regulation	ΔV _O	T _J = 25°C	V _I = -17.5 to -30V	12	300	mV
			V _I = -20 to -26V	6	150	
Load Regulation	ΔV _O	T _J = +25°C		12	300	mV
		I _O = 5mA to 1.5A		4	150	
Quiescent Current	I _Q	T _J = +25°C		3	6	mA
Quiescent Current Change	ΔI _Q	I _O = 5mA to 1A		0.05	0.5	mA
		V _I = -18.5 to -30V		0.1	1	
Temperature Coefficient of V _O	ΔV _O /ΔT	I _O = 5mA		-0.9		mV/°C
Output Noise Voltage	V _N	f = 10Hz to 100KHz T _A = +25°C		250		μV
Ripple Rejection	RR	f = 120Hz ΔV _I = 10V	54	60		dB
Dropout Voltage	V _D	T _J = +25°C I _O = 1A		2		V
Short Circuit Current	I _{SC}	T _J = +25°C, V _I = -35V		300		mA
Peak Current	I _{PK}	T _J = +25°C		2.2		A

* Load and line regulation are specified at constant junction temperature. Changes in V_O due to heating effects must be taken into account separately. Pulse testing with low duty is used.

LM7918 ELECTRICAL CHARACTERISTICS(V_I = 27V, I_O = 500mA, 0°C ≤ T_J ≤ +125°C, C_I = 2.2μF, C_O = 1μF, unless otherwise specified.)

Characteristic	Symbol	Test Conditions	Min	Typ	Max	Unit
Output Voltage	V _O	T _J = +25°C	-17.3	-18	-18.7	V
		I _O = 5mA to 1A, P _O = 15W V _I = -22.5 to -33V	-17.1	-18	-18.9	
Line Regulation	ΔV _O	T _J = 25°C	V _I = -21 to -33V	15	360	mV
			V _I = -24 to -30V	8	180	
Load Regulation	ΔV _O	T _J = +25°C I _O = 5mA to 1.5A		15	360	mV
		T _J = +25°C I _O = 250 to 750mA		5	180	
Quiescent Current	I _Q	T _J = +25°C		3	6	mA
Quiescent Current Change	ΔI _Q	I _O = 5mA to 1A			0.5	mA
		V _I = -22 to -33V			1	
Temperature Coefficient of V _O	ΔV _O /ΔT	I _O = 5mA		-1		mV/°C
Output Noise Voltage	V _N	f = 10Hz to 100KHz T _A = +25°C		300		μV
Ripple Rejection	RR	f = 120Hz ΔV _I = 10V	54	60		dB
Dropout Voltage	V _D	T _J = +25°C I _O = 1A		2		V
Short Circuit Current	I _{SC}	T _J = +25°C, V _I = -35V		300		mA
Peak Current	I _{PK}	T _J = +25°C		2.2		A

* Load and line regulation are specified at constant junction temperature. Changes in V_O due to heating effects must be taken into account separately. Pulse testing with low duty is used.

LM7924 ELECTRICAL CHARACTERISTICS(V_I = 33V, I_O = 500mA, 0°C ≤ T_J ≤ +125°C, C_I = 2.2μF, C_O = 1μF, unless otherwise specified.)

Characteristic	Symbol	Test Conditions	Min	Typ	Max	Unit
Output Voltage	V _O	T _J = +25°C	- 23	- 24	- 25	V
		I _O = 5mA to 1A, P _O ≤ 15W V _I = -27 to -38V	- 22.8	- 24	- 25.2	
Line Regulation	ΔV _O	T _J = 25°C	V _I = - 27 to - 38V	15	480	mV
			V _I = - 30 to - 36V	8	180	
Load Regulation	ΔV _O	T _J = +25°C I _O = 5mA to 1.5A		15	480	mV
		T _J = + 25°C I _O = 250 to 750mA		5	240	
Quiescent Current	I _Q	T _J = + 25°C		3	6	mA
Quiescent Current Change	ΔI _Q	I _O = 5mA to 1A			0.5	mA
		V _I = -27 to -38V			1	
Temperature Coefficient of V _O	ΔV _O /ΔT	I _O = 5mA		-1		mV/°C
Output Noise Voltage	V _N	f = 10Hz to 100KHz T _A = + 25°C		400		μV
Ripple Rejection	RR	f = 120Hz ΔV _I = 10V	54	60		dB
Dropout Voltage	V _D	T _J = +25°C I _O = 1A		2		V
Short Circuit Current	I _{SC}	T _J = + 25°C, V _I = -35V		300		mA
Peak Current	I _{PK}	T _J = +25°C		2.2		A

* Load and line regulation are specified at constant junction temperature. Changes in V_O due to heating effects must be taken into account separately. Pulse testing with low duty is used.

LM7905A ELECTRICAL CHARACTERISTICS(V_I = 10V, I_O = 500mA, 0°C ≤ T_J ≤ +125°C, C_I = 2.2μF, C_O = 1μF, unless otherwise specified.)

Characteristic	Symbol	Test Conditions	Min	Typ	Max	Unit
Output Voltage	V _O	T _J = +25°C	- 4.9	- 5.0	- 5.1	V
		I _O = 5mA to 1A, P _O = 15W V _I = -7 to -20V	- 4.8	- 5.0	- 5.2	
Line Regulation	ΔV _O	T _J = +25°C	V _I = -7 to -20V I _O = 1A	5	50	mV
			V _I = -8 to -12V I _O = 1A	2	25	
		V _I = -7.5 to -25V	7	50		
		V _I = -8 to -12V I _O = 1A	7	50		
Load Regulation	ΔV _O	I _O = 5mA to 1.5A		10	100	mV
		T _J = +25°C I _O = 250 to 750mA		3	50	
Quiescent Current	I _Q	T _J = +25°C		3	6	mA
Quiescent Current Change	ΔI _Q	I _O = 5mA to 1A		0.05	0.5	mA
		V _I = -8 to -25V		0.1	0.8	
Temperature Coefficient of V _D	ΔV _O /ΔT	I _O = 5mA		- 0.4		mV/°C
Output Noise Voltage	V _N	f = 10Hz to 100KHz T _A = +25°C		40		μV
Ripple Rejection	RR	f = 120Hz, I _O = -35V ΔV _I = 10V	54	60		dB
Dropout Voltage	V _D	T _J = +25°C I _O = 1A		2		V
Short Circuit Current	I _{SC}	T _J = +25°C, V _I = -35V		300		mA
Peak Current	I _{PK}	T _J = +25°C		2.2		A

* Load and line regulation are specified at constant junction temperature. Changes in V_O due to heating effects must be taken into account separately. Pulse testing with low duty is used.

LM7912A ELECTRICAL CHARACTERISTICS(V_I = 18V, I_O = 500mA, 0°C ≤ T_J ≤ +125°C, C_I = 2.2μF, C_O = 1μF, unless otherwise specified.)

Characteristic	Symbol	Test Conditions	Min	Typ	Max	Unit	
Output Voltage	V _O	T _J = +25°C	-11.75	-12	-12.25	V	
		I _O = 5mA to 1A, P _O = 15W V _I = -15.5 to -27V	-11.5	-12	-12.5		
Line Regulation	ΔV _O	T _J = +25°C	V _I = -14.5 to -30V		12	240	mV
			V _I = -16 to -22V		6	120	
Load Regulation	ΔV _O	T _J = +25°C		12	240	mV	
		I _O = 5mA to 1.5A		4	120		
Quiescent Current	I _Q	T _J = +25°C		3	6	mA	
Quiescent Current Change	ΔI _Q	I _O = 5mA to 1A		0.05	0.5	mA	
		V _I = -15 to -30V		0.1	1		
Temperature Coefficient of V _O	ΔV _O /ΔT	I _O = 5mA		-0.8		mV/°C	
Output Noise Voltage	V _N	f = 10Hz to 100KHz T _A = +25°C		200		μV	
Ripple Rejection	RR	f = 120Hz ΔV _I = 10V	54	60		dB	
Dropout Voltage	V _D	T _J = +25°C I _O = 1A		2		V	
Short Circuit Current	I _{SC}	T _J = +25°C, V _I = -35V		300		mA	
Peak Current	I _{PK}	T _J = +25°C		2.2		A	

* Load and line regulation are specified at constant junction temperature. Changes in V_O due to heating effects must be taken into account separately. Pulse testing with low duty is used.

LM7915A ELECTRICAL CHARACTERISTICS(V_I = 23V, I_O = 500mA, 0°C ≤ T_J ≤ +125°C, C_I = 2.2μF, C_O = 1μF, unless otherwise specified.)

Characteristic	Symbol	Test Conditions	Min	Typ	Max	Unit
Output Voltage	V _O	T _J = +25°C	-14.7	-15	-15.3	V
		I _O = 5mA to 1A, P _O 15W V _I = -18 to -30V	-14.4	-15	-15.6	
Line Regulation	ΔV _O	T _J = +25°C	V _I = -17.5 to -30V	12	300	mV
			V _I = -20 to -26V	6	150	
Load Regulation	ΔV _O	T _J = +25°C		12	300	mV
		I _O = 5mA to 1.5A		4	150	
Quiescent Current	I _Q	T _J = +25°C		3	6	mA
Quiescent Current Change	ΔI _Q	I _O = 5mA to 1A		0.05	0.5	mA
		V _I = -18.5 to -30V		0.1	1	
Temperature Coefficient of V _O	ΔV _O /ΔT	I _O = 5mA		-0.9		mV/°C
Output Noise Voltage	V _N	f = 10Hz to 100KHz T _A = +25°C		250		μV
Ripple Rejection	RR	f = 120Hz ΔV _I = 10V	54	60		dB
Dropout Voltage	V _D	T _J = +25°C I _O = 1A		2		V
Short Circuit Current	I _{SC}	T _J = +25°C, V _I = -35V		300		mA
Peak Current	I _{PK}	T _J = +25°C		2.2		A

* Load and line regulation are specified at constant junction temperature. Changes in V_O due to heating effects must be taken into account separately. Pulse testing with low duty is used.

TYPICAL PERFORMANCE CHARACTERISTICS

Fig.1 Output Voltage

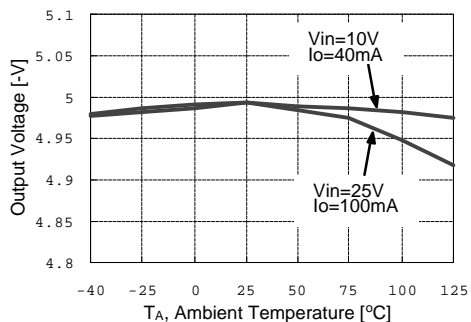

Fig. 2 Load Regulation

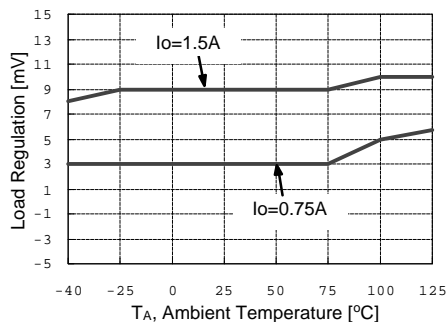

Fig.3 Quiescent Current

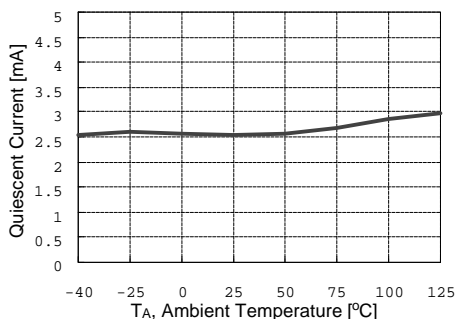

Fig. 4 Dropout Voltage

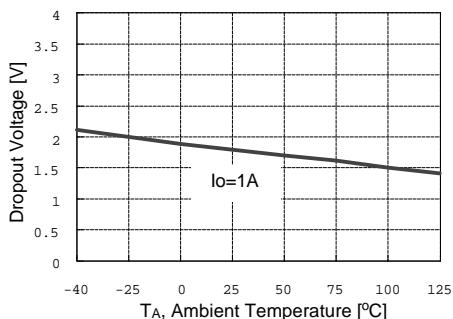
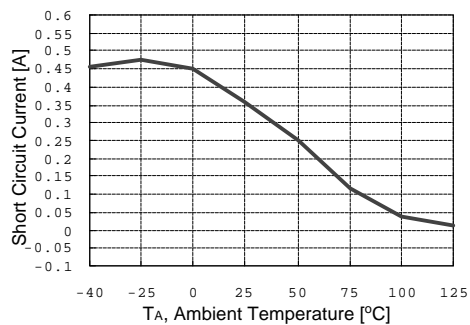
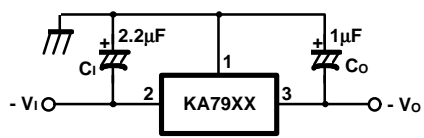

Fig.5 Short Circuit Current



TYPICAL APPLICATIONS

Fig. 6 Negative Fixed output regulator

**Notes:**

- (1) To specify an output voltage, substitute voltage value for "XX"
- (2) Required for stability. For value given, capacitor must be solid tantalum. If aluminum electrolytics are used, at least ten times value shown should be selected. C_i is required if regulator is located an appreciable distance from power supply filter.
- (3) To improve transient response. If large capacitors are used, a high current diode from input to output (1N4001 or similar) should be introduced to protect the device from momentary input short circuit.

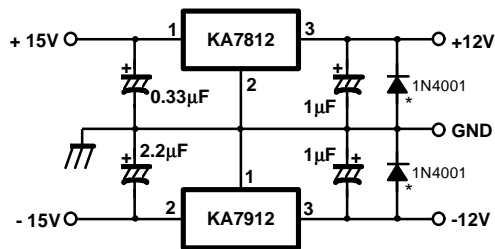
Fig. 7 Split power supply ($\pm 12V/1A$)

*: Against potential latch-up problems.

TRADEMARKS

The following are registered and unregistered trademarks Fairchild Semiconductor owns or is authorized to use and is not intended to be an exhaustive list of all such trademarks.

ACE _x TM	ISOPLANAR TM	TinyLogic TM
CoolFET TM	MICROWIRE TM	UHC TM
CROSSVOLT TM	POP TM	VCX TM
E ² CMOS TM	PowerTrench [®]	
FACT TM	QFET TM	
FACT Quiet Series TM	QS TM	
FAST [®]	Quiet Series TM	
FAST _r TM	SuperSOT TM -3	
GTO TM	SuperSOT TM -6	
HiSeC TM	SuperSOT TM -8	

DISCLAIMER

FAIRCHILD SEMICONDUCTOR RESERVES THE RIGHT TO MAKE CHANGES WITHOUT FURTHER NOTICE TO ANY PRODUCTS HEREIN TO IMPROVE RELIABILITY, FUNCTION OR DESIGN. FAIRCHILD DOES NOT ASSUME ANY LIABILITY ARISING OUT OF THE APPLICATION OR USE OF ANY PRODUCT OR CIRCUIT DESCRIBED HEREIN; NEITHER DOES IT CONVEY ANY LICENSE UNDER ITS PATENT RIGHTS, NOR THE RIGHTS OF OTHERS.

LIFE SUPPORT POLICY

FAIRCHILD'S PRODUCTS ARE NOT AUTHORIZED FOR USE AS CRITICAL COMPONENTS IN LIFE SUPPORT DEVICES OR SYSTEMS WITHOUT THE EXPRESS WRITTEN APPROVAL OF FAIRCHILD SEMICONDUCTOR CORPORATION.
As used herein:

1. Life support devices or systems are devices or systems which, (a) are intended for surgical implant into the body, or (b) support or sustain life, or (c) whose failure to perform when properly used in accordance with instructions for use provided in the labeling, can be reasonably expected to result in significant injury to the user.
2. A critical component is any component of a life support device or system whose failure to perform can be reasonably expected to cause the failure of the life support device or system, or to affect its safety or effectiveness.

PRODUCT STATUS DEFINITIONS

Definition of Terms

Datasheet Identification	Product Status	Definition
Advance Information	Formative or In Design	This datasheet contains the design specifications for product development. Specifications may change in any manner without notice.
Preliminary	First Production	This datasheet contains preliminary data, and supplementary data will be published at a later date. Fairchild Semiconductor reserves the right to make changes at any time without notice in order to improve design.
No Identification Needed	Full Production	This datasheet contains final specifications. Fairchild Semiconductor reserves the right to make changes at any time without notice in order to improve design.
Obsolete	Not In Production	This datasheet contains specifications on a product that has been discontinued by Fairchild semiconductor. The datasheet is printed for reference information only.