

# KAI-16000

## 4872 (H) x 3248 (V) Interline CCD Image Sensor

### Description

The KAI-16000 is an interline transfer CCD offering 16 million pixels at up to 3 frames per second through 2 outputs. This image sensor is organized into an array of 4,872 (H) x 3,248 (V) with 7.4 micron square pixels and full 35 mm optical format. As an interline transfer CCD, the KAI-16000 includes additional features such as progressive scan readout, electronic shutter, low noise, high dynamic range, and blooming suppression. These features make the KAI-16000 the perfect sensor for applications in Industrial, Aerial, Security, and Scientific markets.

**Table 1. GENERAL SPECIFICATIONS**

Parameter	Typical Value
Architecture	Interline CCD; Progressive Scan
Total Number of Pixels	4960 (H) x 3324 (V) = 16.6M
Number of Effective Pixels	4904 (H) x 3280 (V) = 16.1M
Number of Active Pixels	4872 (H) x 3248 (V) = 15.8M
Pixel Size	7.4 $\mu\text{m}$ (H) x 7.4 $\mu\text{m}$ (V)
Active Image Size	36.1 mm (H) x 24.0 mm (V) 43.3 mm (diagonal), 35 mm Optical Format
Aspect Ratio	3:2
Number of Outputs	1 or 2
Saturation Signal	30,000 electrons
Output Sensitivity	30 $\mu\text{V}/\text{e}^-$
Quantum Efficiency KAI-16000-AXA KAI-16000-CXA (RGB) KAI-16000-FXA (RGB)	47% 29%, 38%, 44% 31%, 39%, 45%
Read Noise (f = 30 MHz)	16 electrons
Dark Current	< 0.5 nA/cm <sup>2</sup>
Dark Current Doubling Temperature	7°C
Dynamic Range	65 dB
Charge Transfer Efficiency	0.99999
Blooming Suppression	> 100 X
Smear	< -80 dB
Image Lag	< 10 electrons
Maximum Data Rate	30 MHz per channel
Package	40 pin Grid Array
Cover Glass	AR coated, 2 sides

NOTE: All parameters above are specified at T = 40°C



**ON Semiconductor®**

[www.onsemi.com](http://www.onsemi.com)



**Figure 1. KAI-16000 CCD Image Sensor**

### Features

- 16 Million Pixel Resolution
- Electronic Shutter
- 35 mm Optical Format
- Progressive Scan Readout
- High Sensitivity
- Fast Frame Rate
- > 60 dB Dynamic Range

### Applications

- Industrial
- Aerial Photography
- Security
- Scientific

### ORDERING INFORMATION

See detailed ordering and shipping information on page 2 of this data sheet.

# KAI-16000

## ORDERING INFORMATION

**Table 2. ORDERING INFORMATION**

Part Number	Description	Marking Code
KAI-16000-AAA-JR-B1	Monochrome, No Microlens, PGA Package, Taped Clear Cover Glass with AR coating (2 sides), Grade 1	KAI-16000-AAA Serial Number
KAI-16000-AAA-JR-B2	Monochrome, No Microlens, PGA Package, Taped Clear Cover Glass with AR coating (2 sides), Grade 2	
KAI-16000-AAA-JR-AE	Monochrome, No Microlens, PGA Package, Taped Clear Cover Glass with AR coating (2 sides), Engineering Grade	
KAI-16000-AAA-JD-B1	Monochrome, No Microlens, PGA Package, Sealed Clear Cover Glass with AR coating (2 sides), Grade 1	
KAI-16000-AAA-JD-B2	Monochrome, No Microlens, PGA Package, Sealed Clear Cover Glass with AR coating (2 sides), Grade 2	
KAI-16000-AAA-JD-AE	Monochrome, No Microlens, PGA Package, Sealed Clear Cover Glass with AR coating (2 sides), Engineering Grade	
KAI-16000-AXA-JD-BX	Monochrome, Special Microlens, PGA Package, Clear Cover Glass with AR coating (both sides), Special Grade	KAI-16000-AXA Serial Number
KAI-16000-AXA-JD-B1	Monochrome, Special Microlens, PGA Package, Clear Cover Glass with AR coating (both sides), Grade 1	
KAI-16000-AXA-JD-B2	Monochrome, Special Microlens, PGA Package, Clear Cover Glass with AR coating (both sides), Grade 2	
KAI-16000-AXA-JD-AE	Monochrome, Special Microlens, PGA Package, Clear Cover Glass with AR coating (both sides), Engineering Grade	
KAI-16000-AXA-JR-B1	Monochrome, Special Microlens, PGA Package, Taped Clear Cover Glass with AR coating (2 sides), Grade 1	
KAI-16000-AXA-JR-B2	Monochrome, Special Microlens, PGA Package, Taped Clear Cover Glass with AR coating (2 sides), Grade 2	
KAI-16000-AXA-JR-AE	Monochrome, Special Microlens, PGA Package, Taped Clear Cover Glass with AR coating (2 sides), Engineering Grade	KAI-16000-FXA Serial Number
KAI-16000-FXA-JD-B1	Gen2 Color (Bayer RGB), Special Microlens, PGA Package, Clear Cover Glass with AR coating (both sides), Grade 1	
KAI-16000-FXA-JD-B2	Gen2 Color (Bayer RGB), Special Microlens, PGA Package, Clear Cover Glass with AR coating (both sides), Grade 2	
KAI-16000-FXA-JD-AE	Gen2 Color (Bayer RGB), Special Microlens, PGA Package, Clear Cover Glass with AR coating (both sides), Engineering Grade	KAI-16000-CXA Serial Number
KAI-16000-CXA-JD-B1 (Note 1)	Gen1 Color (Bayer RGB), Special Microlens, PGA Package, Clear Cover Glass with AR coating (both sides), Grade 1	
KAI-16000-CXA-JD-B2 (Note 1)	Gen1 Color (Bayer RGB), Special Microlens, PGA Package, Clear Cover Glass with AR coating (both sides), Grade 2	
KAI-16000-CXA-JD-AE (Note 1)	Gen1 Color (Bayer RGB), Special Microlens, PGA Package, Clear Cover Glass with AR coating (both sides), Engineering Grade	

1. Not recommended for new designs.

See the ON Semiconductor *Device Nomenclature* document (TND310/D) for a full description of the naming convention used for image sensors. For reference documentation, including information on evaluation kits, please visit our web site at [www.onsemi.com](http://www.onsemi.com).

DEVICE DESCRIPTION

Architecture



Figure 2. Sensor Architecture

There are 40 light shielded gray rows followed 3280 photoactive rows and finally 4 more light shielded gray rows. The first 16 and the last 16 photoactive rows are buffer rows giving a total of 3248 lines of image data.

In the single output mode all pixels are clocked out of the Video L output in the lower left corner of the sensor. The first 12 empty pixels of each line do not receive charge from the vertical shift register. The next 28 pixels receive charge from the left light shielded edge followed by 4904 photosensitive pixels and finally 28 more light shielded pixels from the right edge of the sensor. The first 16 and last 16 photosensitive pixels are buffer pixels giving a total of 4872 pixels of image data.

In the dual output mode the clocking of the right half of the horizontal CCD is reversed. The left half of the image is

clocked out Video L and the right half of the image is clocked out Video R. For the Video L each row consists of 12 empty pixels followed by 28 light shielded pixels followed by 2452 photosensitive pixels. For the Video R each row consists of 12 empty pixels followed by 28 light shielded pixels followed by 2452 photosensitive pixels. When reconstructing the image, data from Video R will have to be reversed in a line buffer and appended to the Video L data.

The gray rows are not entirely dark and so should not be used for a dark reference level. Use the dark columns on the left or right side of the image sensor as a dark reference.

Of the dark columns, the first and last dark columns should not be used for determining the zero signal level. Some light does leak into the first and last dark columns.

**PHYSICAL DESCRIPTION**

**Pin Description and Device Orientation**



**Figure 3. Package Pin Designations – Top View**

**Table 3. PINOUT**

Pin	Name	Description
1	VOUTL	Video Output, Left
2	VDDL	V <sub>DD</sub> , Left
3	GND	Ground
4	RESETL	Reset Gate, Left
5	HLASTL	Horizontal Clock, Last Stage, Left
6	H2BL	Horizontal Clock, Phase 2, Barrier, Left
7	H1BL	Horizontal Clock, Phase 1, Barrier, Left
8	H1SL	Horizontal Clock, Phase 1, Storage, Left
9	H2SL	Horizontal Clock, Phase 2, Storage, Left
10	ESD	ESD Protection Disable
11	GND	Ground
12	H2SR	Horizontal Clock, Phase 2, Storage, Right
13	H1SR	Horizontal Clock, Phase 1, Storage, Right
14	H1BR	Horizontal Clock, Phase 1, Barrier, Right
15	H2BR	Horizontal Clock, Phase 2, Barrier, Right
16	HLASTR	Horizontal Clock, Last Stage, Right
17	RESETR	Reset Gate, Right
18	GND	Ground
19	VDDR	V <sub>DD</sub> , Right
20	VOUTR	Video Output, Right

Pin	Name	Description
40	FDGL	Fast Line Dump Gate, Left
39	RDL	Reset Drain, Left
38	SUB	Substrate
37	GND	Ground
36	V1	VCCD Gate 1, Phase 2
35	V5	VCCD Gate 5, Phase 2
34	V9	VCCD Gate 9, Phase 2
33	V3	VCCD Gate 3, Phase 2
32	V7	VCCD Gate 7, Phase 2
31	V11	VCCD Gate 11, Phase 2
30	V2	VCCD Gate 2, Phase 1
29	V6	VCCD Gate 6, Phase 1
28	V10	VCCD Gate 10, Phase 1
27	V4	VCCD Gate 4, Phase 1
26	V8	VCCD Gate 8, Phase 1
25	V12	VCCD Gate 12, Phase 1
24	GND	Ground
23	SUB	Substrate
22	RDR	Reset Drain, Right
21	FDGR	Fast Line Dump Gate, Right

## IMAGING PERFORMANCE

**Table 4. TYPICAL OPERATION CONDITIONS**

Unless otherwise noted, the Imaging Performance Specifications are measured using the following conditions.

Description	Condition	Notes
Frame Time	908 msec	1
Horizontal Clock Frequency	20 MHz	
Light Source	Continuous red, green and blue illumination centered at 450, 530 and 650 nm	2, 3
Operation	Nominal operating voltages and timing	

1. Electronic shutter is not used. Integration time equals frame time.
2. LEDs used: Blue: Nichia NLPB500, Green: Nichia NSPG500S and Red: HP HLMP-8115.
3. For monochrome sensor, only green LED used.

**Table 5. SPECIFICATIONS**

Description	Symbol	Min.	Nom.	Max.	Units	Sample Plan <sup>7</sup>	Temperature Tested At (°C)	Notes
Global Non-Uniformity		n/a	2.5	5.0	%rms	Die	27, 40	1
Maximum Photoresponse Nonlinearity	NL	n/a	2		%	Design		2, 3
Maximum Gain Difference Between Outputs	$\Delta G$	n/a	10		%	Design		2, 3
Maximum Signal Error due to Nonlinearity Differences	$\Delta NL$	n/a	1		%	Design		2, 3
Horizontal CCD Charge Capacity	HNe		100		ke <sup>-</sup>	Design		
Vertical CCD Charge Capacity	VNe		50		ke <sup>-</sup>	Die	27, 40	
Photodiode Charge Capacity	PNe	28	30		ke <sup>-</sup>	Die	27, 40	4
Horizontal CCD Charge Transfer Efficiency	HCTE	0.99999		n/a		Design		
Vertical CCD Charge Transfer Efficiency	VCTE	0.99999				Design		
Photodiode Dark Current	l <sub>pd</sub>	n/a n/a	40 0.01	350 0.1	e/p/s nA/cm <sup>2</sup>	Die	40	
Vertical CCD Dark Current	l <sub>vd</sub>	n/a n/a	400 0.12	1711 0.5	e/p/s nA/cm <sup>2</sup>	Die	40	
Dark Current Doubling Temperature	$\Delta T$	n/a	7	n/a	°C	Design		
Image Lag	Lag	n/a	<10	50	e <sup>-</sup>	Design		
Antiblooming Factor	X <sub>ab</sub>	100	300	n/a		Design		
Vertical Smear	S <sub>mr</sub>	n/a	-80	-75	dB	Design		
Read Noise	$n_{e-T}$		16		e <sup>-</sup> rms	Design		5
Dynamic Range	DR		65		dB	Design		5, 6
Output Amplifier DC Offset	V <sub>odc</sub>	4	9.5	14	V	Die	27, 40	
Output Amplifier Bandwidth	F <sub>-3db</sub>		140		MHz	Design		
Output Amplifier Impedance	R <sub>OUT</sub>	100	130	200	$\Omega$	Die	27, 40	
Output Amplifier Sensitivity	$\Delta V/\Delta N$		30		$\mu V/e^-$	Design		

1. Per color
2. Value is over the range of 10% to 90% of photodiode saturation.
3. Value is for the sensor operated without binning.
4. The operating value of the substrate voltage, V<sub>AB</sub>, will be marked on the shipping container for each device. The value of V<sub>ab</sub> is set such that the photodiode charge capacity is 30,000 electrons.
5. At 30 MHz
6. Uses 20LOG (PNe/  $n_{e-T}$ )
7. "Die" indicates a parameter that is measured on every sensor during the production testing. "Design" designates a parameter that is quantified during the design verification activity.

# KAI-16000

**Table 6. KAI-16000-AAA**

Description	Symbol	Min.	Nom.	Max.	Units	Sample Plan <sup>1</sup>	Temperature Tested At (°C)	Notes
Peak Quantum Efficiency	QE <sub>max</sub>		11	n/a	%	Design		
Peak Quantum Efficiency Wavelength	λQE	n/a	500	n/a	nm	Design		

1. "Die" indicates a parameter that is measured on every sensor during the production testing. "Design" designates a parameter that is quantified during the design verification activity.

**Table 7. KAI-16000-AXA**

Description	Symbol	Min.	Nom.	Max.	Units	Sample Plan <sup>1</sup>	Temperature Tested At (°C)	Notes
Peak Quantum Efficiency	QE <sub>max</sub>		45	n/a	%	Design		
Peak Quantum Efficiency Wavelength	λQE	n/a	500	n/a	nm	Design		

1. "Die" indicates a parameter that is measured on every sensor during the production testing. "Design" designates a parameter that is quantified during the design verification activity.

**Table 8. KAI-16000-FXA (Gen2)**

Description	Symbol	Min.	Nom.	Max.	Units	Sample Plan <sup>1</sup>	Temperature Tested At (°C)	Notes
Peak Quantum Efficiency	QE <sub>max</sub>		45	n/a	%	Design		
Blue			39	n/a				
Green			31	n/a				
Peak Quantum Efficiency Wavelength	λQE	n/a	460	n/a	nm	Design		
Blue		n/a	525	n/a				
Green		n/a	600	n/a				

1. "Design" designates a parameter that is quantified during the design verification activity.

**Table 9. KAI-16000-CXA (Gen1)**

Description	Symbol	Min.	Nom.	Max.	Units	Sample Plan <sup>1</sup>	Temperature Tested At (°C)	Notes
Peak Quantum Efficiency	QE <sub>max</sub>		44	n/a	%	Design		2
Blue			38	n/a				
Green			29	n/a				
Peak Quantum Efficiency Wavelength	λQE	n/a	470	n/a	nm	Design		2
Blue		n/a	540	n/a				
Green		n/a	620	n/a				

1. "Design" designates a parameter that is quantified during the design verification activity.  
 2. This color filter set configuration (Gen1) is not recommended for new designs.

NOTE: n/a = not applicable

TYPICAL PERFORMANCE CURVES

Monochrome with Microlens Quantum Efficiency

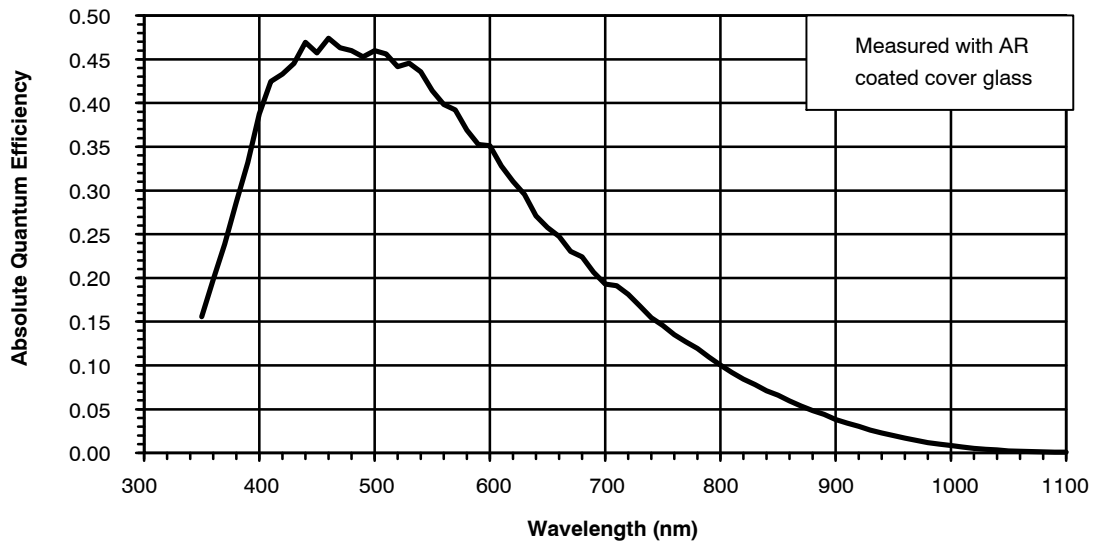

Figure 4. Monochrome with Microlens Quantum Efficiency

Monochrome without Microlens Quantum Efficiency

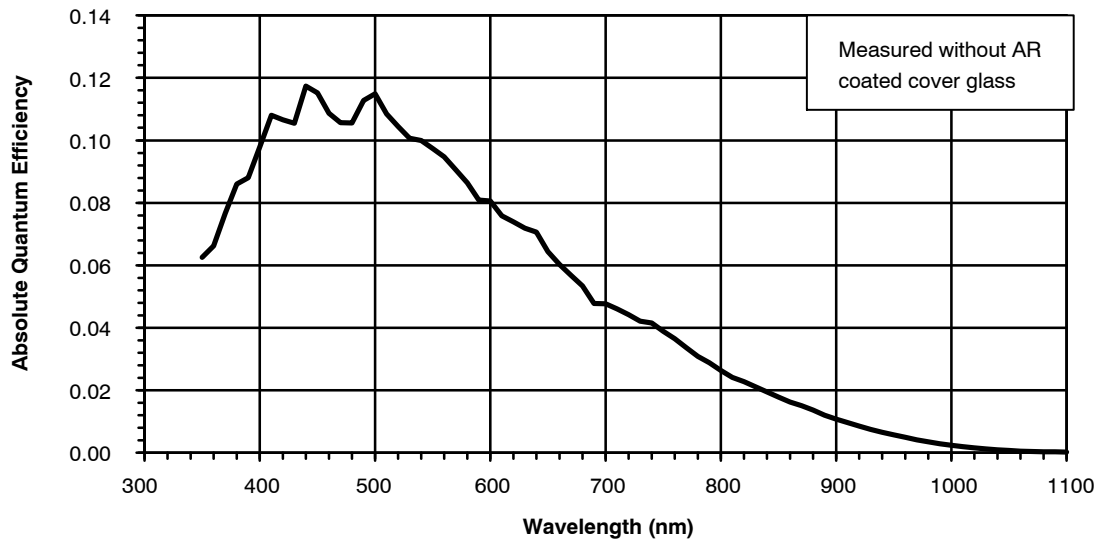

Figure 5. Monochrome without Microlens Quantum Efficiency

Color with Microlens Quantum Efficiency

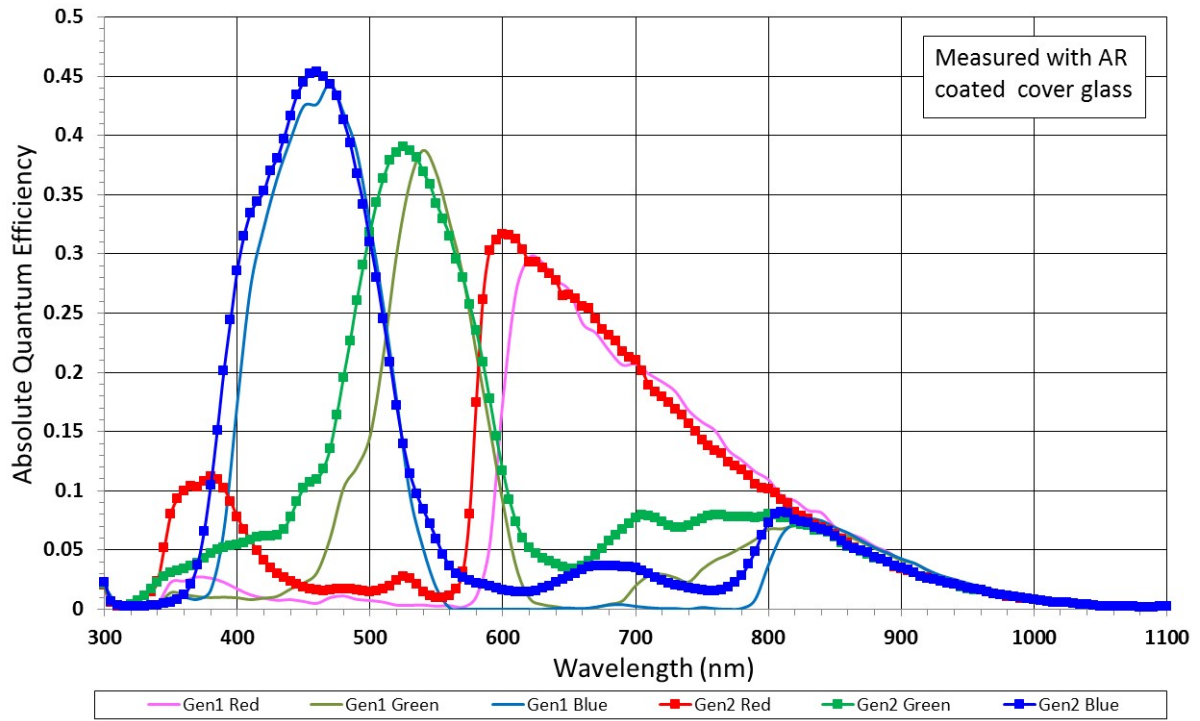

Figure 6. Color with Microlens Quantum Efficiency



**Angular Quantum Efficiency**

For the curves marked “Horizontal”, the incident light angle is varied in a plane parallel to the HCCD.

For the curves marked “Vertical”, the incident light angle is varied in a plane parallel to the VCCD.

**Monochrome with Microlens**



Figure 7. Monochrome with Microlens Angular Quantum Efficiency

**DEFECT DEFINITIONS**

**Operational Conditions**

All defect tests performed at  $t_{int} = t_{frame} = 908 \text{ msec}$

**Table 10. SPECIFICATIONS**

Description	Definition	Class X Monochrome with Microlens Only	Class 1	Class 2 Monochrome	Class 2 Color	Notes
Major dark field defective bright pixel	Defect $\geq 245 \text{ mV}$	150	150	300	300	2
Major bright field defective dark pixel	Defect $\geq 15\%$					
Minor dark field defective bright pixel	Defect $\geq 126 \text{ mV}$	1500	1500	3000	3000	3
Cluster defect	A group of 2 to "N" contiguous major defective pixels, but no more than "W" adjacent defects horizontally.	0	30 N = 20 W = 4	30 N = 20 W = 4	30 N = 20 W = 4	1, 2
Column defect	A group of more than 10 contiguous major defective pixels along a single column	0	0	4	15	1, 2

1. Column and cluster defects are separated by no less than two (2) pixels in any direction (excluding single pixel defects).
2. Tested at 27°C and 40°C.
3. Tested at 40°C.

NOTE: Class X sensors are offered strictly "as available". ON Semiconductor cannot guarantee delivery dates. Please call for availability.

**Defect Map**

The defect map supplied with each sensor is based upon testing at an ambient (27°C) temperature. Minor point

defects are not included in the defect map. All defective pixels are reference to pixel 1, 1 in the defect maps.

**TEST DEFINITIONS**

**Test Regions of Interest**

Image Area ROI: Pixel (1, 1) to Pixel (4872, 3248)

Only the active pixels are used for performance and defect tests.

**Overclocking**

The test system timing is configured such that the sensor is overclocked in both the vertical and horizontal directions. See Figure 8 for a pictorial representation of the regions.



**Figure 8. Overclock Regions of Interest**

**Tests**

*Global Non-Uniformity*

This test is performed with the imager illuminated to a level such that the output is at 70% of saturation (approximately 630 mV). Prior to this test being performed

$$\text{GlobalNon-Uniformity} = 100 \times \left( \frac{\text{ActiveAreaStandardDeviation}}{\text{ActiveAreaSignal}} \right)$$

Units: %rms.

Active Area Signal = Active Area Average – Dark Column Average

*Dark Field Defect Test*

This test is performed under dark field conditions. The sensor is partitioned into 384 sub regions of interest, each of which is 203 by 203 pixels in size. In each region of interest, the median value of all pixels is found. For each region of interest, a pixel is marked defective if it is greater than or equal to the median value of that region of interest plus the defect threshold specified in the “Defect Definitions” section.

the substrate voltage has been set such that the charge capacity of the sensor is 900 mV. Global non-uniformity is defined as

*Bright Field Defect Test*

This test is performed with the imager illuminated to a level such that the output is at approximately 630 mV. Prior to this test being performed the substrate voltage has been set such that the charge capacity of the sensor is 900 mV. The average signal level of all active pixels is found. The bright and dark thresholds are set as:

Dark defect threshold = Active Area Signal \* threshold  
 Bright defect threshold = Active Area Signal \* threshold

The sensor is then partitioned into 384 sub regions of interest, each of which is 203 by 203 pixels in size. In each region of interest, the average value of all pixels is found. For each region of interest, a pixel is marked defective if it is greater than or equal to the median value of that region of interest plus the bright threshold specified or if it is less than or equal to the median value of that region of interest minus the dark threshold specified.

Example for major bright field defective pixels:

- Average value of all active pixels is found to be 630 mV
- Dark defect threshold: 630 mV \* 15% = 95 mV
- Bright defect threshold: 630 mV \* 15% = 95 mV
- Region of interest #1 selected. This region of interest is pixels 1, 1 to pixels 203, 203.
  - ♦ Median of this region of interest is found to be 630 mV.
  - ♦ Any pixel in this region of interest that is  $\geq (630 + 95 \text{ mV})$  725 mV in intensity will be marked defective.
  - ♦ Any pixel in this region of interest that is  $\leq (630 - 95 \text{ mV})$  535 mV in intensity will be marked defective.
- All remaining 384 sub regions of interest are analyzed for defective pixels in the same manner.

## OPERATION

Table 11. ABSOLUTE MAXIMUM RATINGS

Description	Symbol	Minimum	Maximum	Units	Notes
Operating Temperature	T <sub>OP</sub>	-50	70	°C	1
Humidity	RH	5	90	%	2
Output Bias Current	I <sub>out</sub>	0.0	-40	mA	3
Off-chip Load	C <sub>L</sub>		10	pF	

Stresses exceeding those listed in the Maximum Ratings table may damage the device. If any of these limits are exceeded, device functionality should not be assumed, damage may occur and reliability may be affected.

- Noise performance will degrade at higher temperatures.
- T = 25°C. Excessive humidity will degrade MTTF.
- Total for all outputs. Maximum current is -20 mA for each output. Avoid shorting output pins to ground or any low impedance source during operation. Amplifier bandwidth increases at higher current and lower load capacitance at the expense of reduced gain (sensitivity). Operation at these values will reduce MTTF.

Table 12. MAXIMUM VOLTAGE RATINGS BETWEEN PINS

Description	Minimum	Maximum	Units	Notes
RL, RR, H1SL, H1BL, H2SL, H2BL, H1SR, H1BR, H2SR, H2BR, HLASTL, HLASTR to ESD	0	17	V	
Pin to Pin with ESD Protection	-17	17	V	1
VDDL, VDDR to GND	0	25	V	

- Pins with ESD protection are: RL, RR, H1SL, H1BL, H2SL, H2BL, H1SR, H1BR, H2SR, H2BR, HLASTL, and HLASTR

## Power-Up Sequence

- Substrate
- ESD Protection Disable
- All other clocks and biases

Table 13. DC BIAS OPERATING CONDITIONS

Description	Symbol	Pins	Minimum	Nominal	Maximum	Units	Maximum DC Current (mA)	Notes
Reset Drain	RD	RDL, RDR	+11.5	+12.0	+12.0	V		
Output Amplifier Supply	VDD	VDDL, VDDR	+14.5	+15.0	+15.5	V		4
Ground	GND	GND	0.0	0.0	0.0	V		
Substrate	SUB	SUB	+8.0	VAB	+16.0	V		1, 5
ESD Protection Disable	ESD	ESD	-9.25	-9.0	-8.75	V		2
Output Bias Current	I <sub>out</sub>	VOU <sub>TL</sub> , VOU <sub>TR</sub>		-5.0	-10.0	mA		3

- The operating of the substrate voltage, VAB, will be marked on the shipping container for each device. The value of Vab is set such that the photodiode charge capacity is 30,000 electrons.
- VESD must be at least 1 V more negative than H1<sub>lo</sub> and H2<sub>lo</sub> during sensor operation AND during camera power turn on.
- An output load sink must be applied to Vout to activate output amplifier.
- The maximum DC current is for one output unloaded. This is the maximum current that the first two stages of one output amplifier will draw. This value is with Vout disconnected.
- Refer to Application Note *Using Interline CCD Image Sensors in High Intensity Visible Lighting Conditions*

AC Operating Conditions

Table 14. CLOCK LEVELS

Description	Pins	Symbol	Minimum	Nominal	Maximum	Units	Notes
Vertical CCD Clock High	V1, V3, V5, V7, V9, V11	V_2hi	+8.5	+9.0	+9.5	V	
Vertical CCD Clocks Midlevel	V1, V2, V3, V4, V5, V6, V7, V8, V9, V10, V11, V12	V_1mid, V_2mid	-0.2	0.0	+0.2	V	
Vertical CCD Clocks Low	V1, V2, V3, V4, V5, V6, V7, V8, V9, V10, V11, V12	V_1lo, V_2lo	-9.5	-9.0	-8.5	V	
Horizontal CCD Clocks Amplitude, Phase 1 Storage	H1S $\alpha$ H1SL, H1BL, H2SL, H2BL, H1SR, H1BR, H2SR, H2BRK	H_amp	+4.5	+5.0	+5.5	V	
Horizontal CCD Clocks Low	H1SL, H1BL, H2SL, H2BL, H1SR, H1BR, H2SR, H2BR	H_lo	-5.0	-4.5	-4.0	V	
Horizontal Last CCD Amplitude	HLASTL, HLASTR	HLAST_amp	+4.5	+5.0	+5.5	V	
Horizontal Last CCD Low	HLASTL, HLASTR	HLAST_lo	-5.0	-4.5	-4.0	V	
Reset Clock Amplitude	RESETL, RESETR	R_amp	+4.5	+5.0	+5.5	V	
Reset Clock Low	RESETL, RESETR	R_lo	-3.5	-3.0	-2.5	V	
Electronic Shutter Voltage	SUB	Vshutter	+44	+48	+52	V	1
Fast Dump High	FDL, FDR	FD_hi	+4.5	+5.0	+5.5	V	
Fast Dump Low	FDL, FDR	FD_lo	-9.5	-9.0	-8.5	V	

1. Refer to Application Note *Using Interline CCD Image Sensors in High Intensity Visible Lighting Conditions*

The figure below shows the DC bias (SUB) and AC clock (Vshutter) applied to the SUB pin. Both the DC bias and AC clock are referenced to ground.

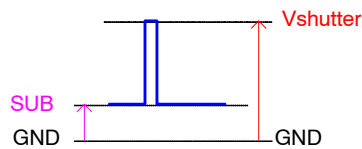

Figure 9.

**Table 15. CLOCK LINE CAPACITANCES**

Clocks	Capacitance	Units	Notes
Vertical CCD Phase 1 to GND	108	nF	1, 3
Vertical CCD Phase 2 to GND	118	nF	1, 4
Vertical CCD Phase 1 to Vertical CCD Phase 2	56	nF	3, 4
H1S to GND	27	pF	2
H2S to GND	27	pF	2
H1B to GND	13	pF	2
H2B to GND	4	pF	2
H1S to H2B and H2S	13	pF	2
H1B to H2B and H2S	13	pF	2
H2S to H1B and H1S	13	pF	2
H2B to H1B and H1S	13	pF	2
HLAST to GND	20	pF	2
RESET to GND	10	pF	
FD to GND	20	pF	

1. Gate capacitance to GND is voltage dependent. Value is for nominal VCCD clock voltages.
2. For nominal HCCD clock voltages, these values are for half of the imager (H1SL, H1BL, H2SL, H2BL and H1BINL or H1SR, H1BR, H2SR, H2BR and H1BINR).
3. Vertical CCD Phase 1: V2, V4, V6, V8, V10, V12
4. Vertical CCD Phase 2: V1, V3, V5, V7, V9, V11

**TIMING**

**Table 16. REQUIREMENTS AND CHARACTERISTICS**

Description	Symbol	Minimum	Nominal	Maximum	Units	Notes
VCCD to HCCD Delay	$T_{HD}$	4	6		$\mu s$	
VCCD Transfer Time	$T_{VCCD}$	4	6		$\mu s$	
HCCD to VCCD Delay	$T_{HL}$		50		ns	
Photodiode Transfer Time	$T_{V3rd}$	10	12		$\mu s$	
VCCD Pedestal Time	$T_{3P}$	200	600		$\mu s$	
VCCD Delay	$T_{3D}$	12	20		$\mu s$	
VCCD Delay Before Pedestal	$T_{DEL}$		50		ns	
VCCD Delay Before 1 <sup>st</sup> Line	$T_{D1L}$	10	60		$\mu s$	
Reset Pulse Time	$T_R$		3.25		$\mu s$	
VCCD to HCCD Delay – Shutter	$T_{HDS}$		6		$\mu s$	
Shutter Pulse Time	$T_S$		4		$\mu s$	
Shutter Pulse Delay	$T_{SD}$		1.5		$\mu s$	
HCCD Clock Period	$T_H$	33.3			ns	
VCCD Rise/Fall Time	$T_{VR}$	0.2			$\mu s$	
Fast Dump Gate Leading Delay	$T_{FDL}$	0.5			$\mu s$	
Fast Dump Gate Trailing Delay	$T_{FDT}$	0.5			$\mu s$	
VCCD Line Clock Leading Edge Delay	$T_{VL}$	0.2	0.3	0.4	$\mu s$	
VCCD Line Clock Trailing Edge Delay	$T_{VT}$	0.0	0.2	0.4	$\mu s$	

**Main Timing – Continuous Mode**



**Figure 10. Main Timing – Continuous Mode**



Frame Timing – Continuous Mode



Figure 11. Framing Timing

Line Timing Continuous Mode

Line Timing Single Output

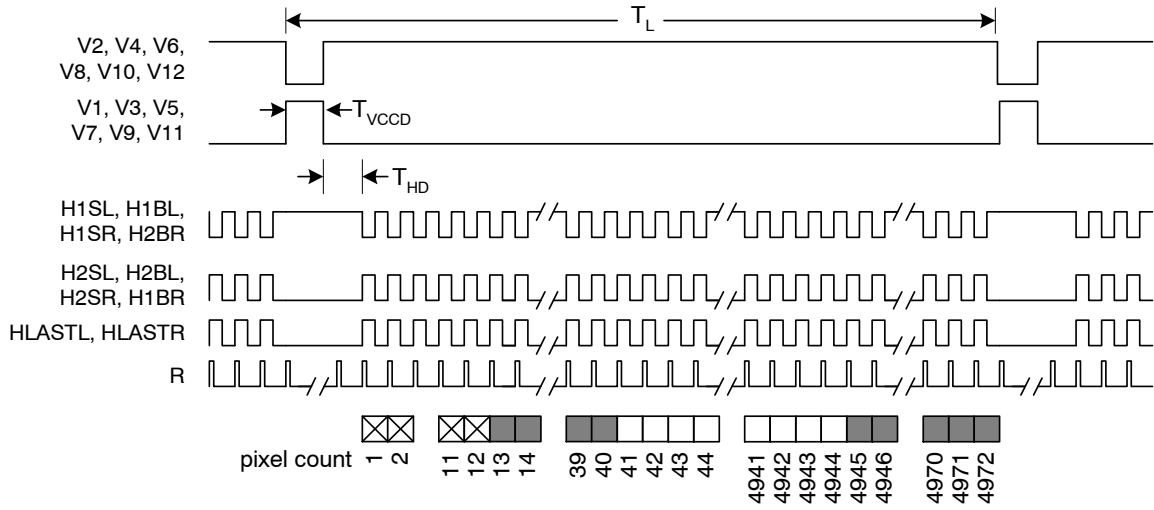

Figure 12. Line Timing Single Output

Line Timing Double Output

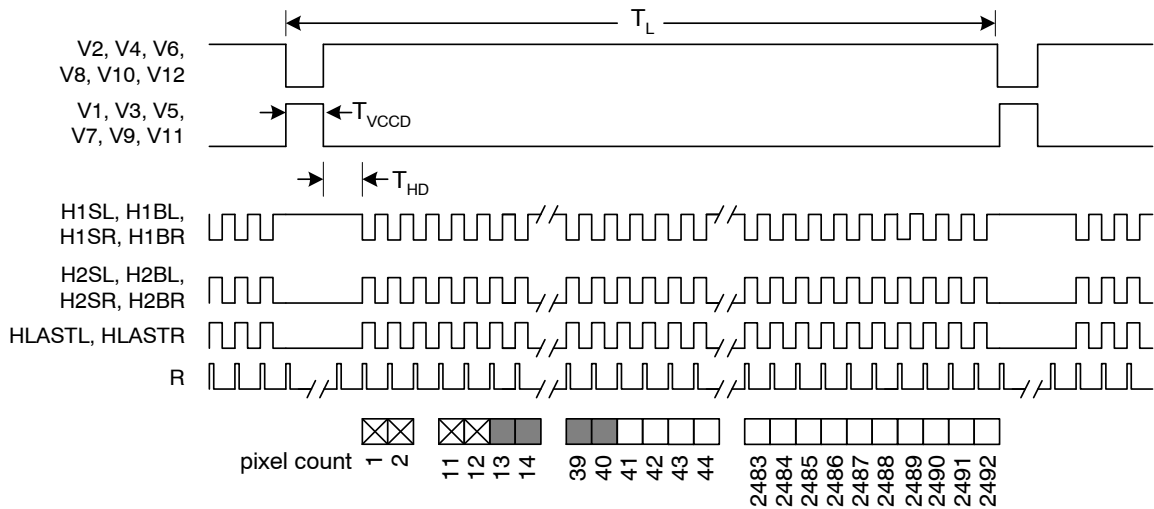

Figure 13. Line Timing Dual Output

Line Timing Detail Single Output



Figure 14. Line Timing Detail Single Output

Line Timing Detail Edge Alignment

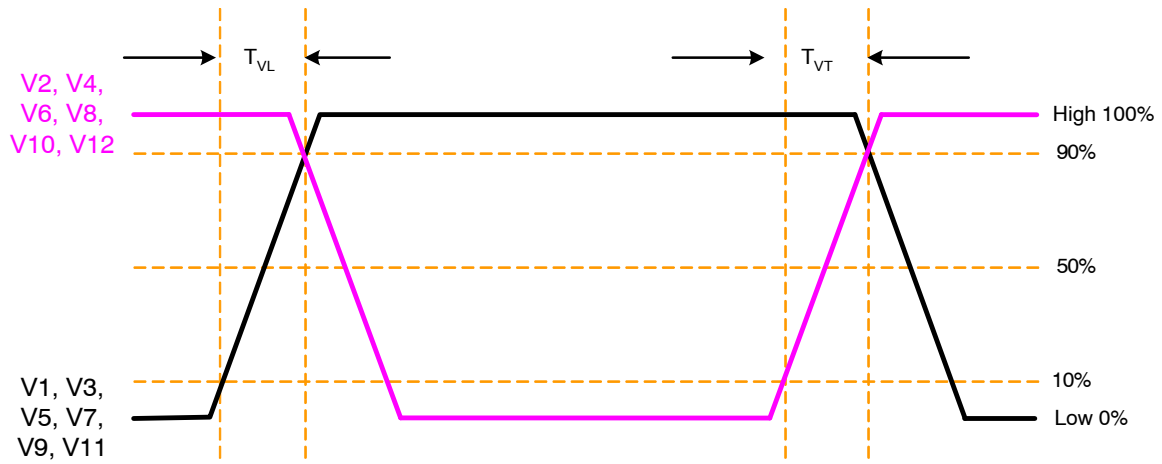

Figure 15. Line Timing Detail Edge Alignment

Pixel Timing

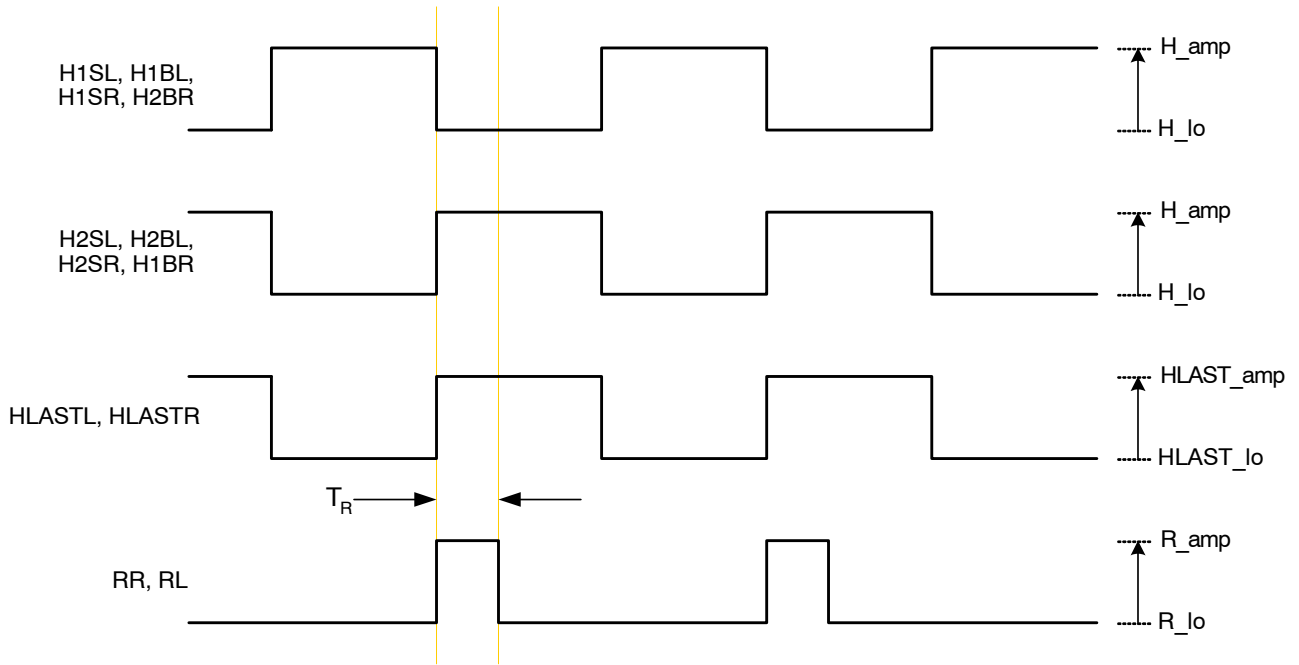

Figure 16. Pixel Timing

Fast Line Dump Timing



Figure 17. Fast Line Dump Timing

Electronic Shutter Timing



Figure 18. Electronic Shutter Timing

Electronic Shutter Integration Time Definition



Figure 19. Integration Time Definition

## STORAGE AND HANDLING

Table 17. STORAGE CONDITIONS

Description	Symbol	Minimum	Maximum	Units	Notes
Temperature	T	-55	80	°C	1
Humidity	RH	5	90	%	2

1. Long-term exposure toward the maximum temperature will accelerate color filter degradation.
2. T = 25°C. Excessive humidity will degrade MTTF.

For information on ESD and cover glass care and cleanliness, please download the *Image Sensor Handling and Best Practices* Application Note (AN52561/D) from [www.onsemi.com](http://www.onsemi.com).

For information on soldering recommendations, please download the *Soldering and Mounting Techniques Reference Manual* (SOLDERRM/D) from [www.onsemi.com](http://www.onsemi.com).

For quality and reliability information, please download the *Quality & Reliability Handbook* (HBD851/D) from [www.onsemi.com](http://www.onsemi.com).

For information on device numbering and ordering codes, please download the *Device Nomenclature* technical note (TND310/D) from [www.onsemi.com](http://www.onsemi.com).

For information on Standard terms and Conditions of Sale, please download [Terms and Conditions](http://www.onsemi.com) from [www.onsemi.com](http://www.onsemi.com).

MECHANICAL DRAWINGS

Completed Assembly



Figure 20. Completed Assembly (1 of 2)





Figure 21. Completed Assembly (2 of 2)

Cover Glass

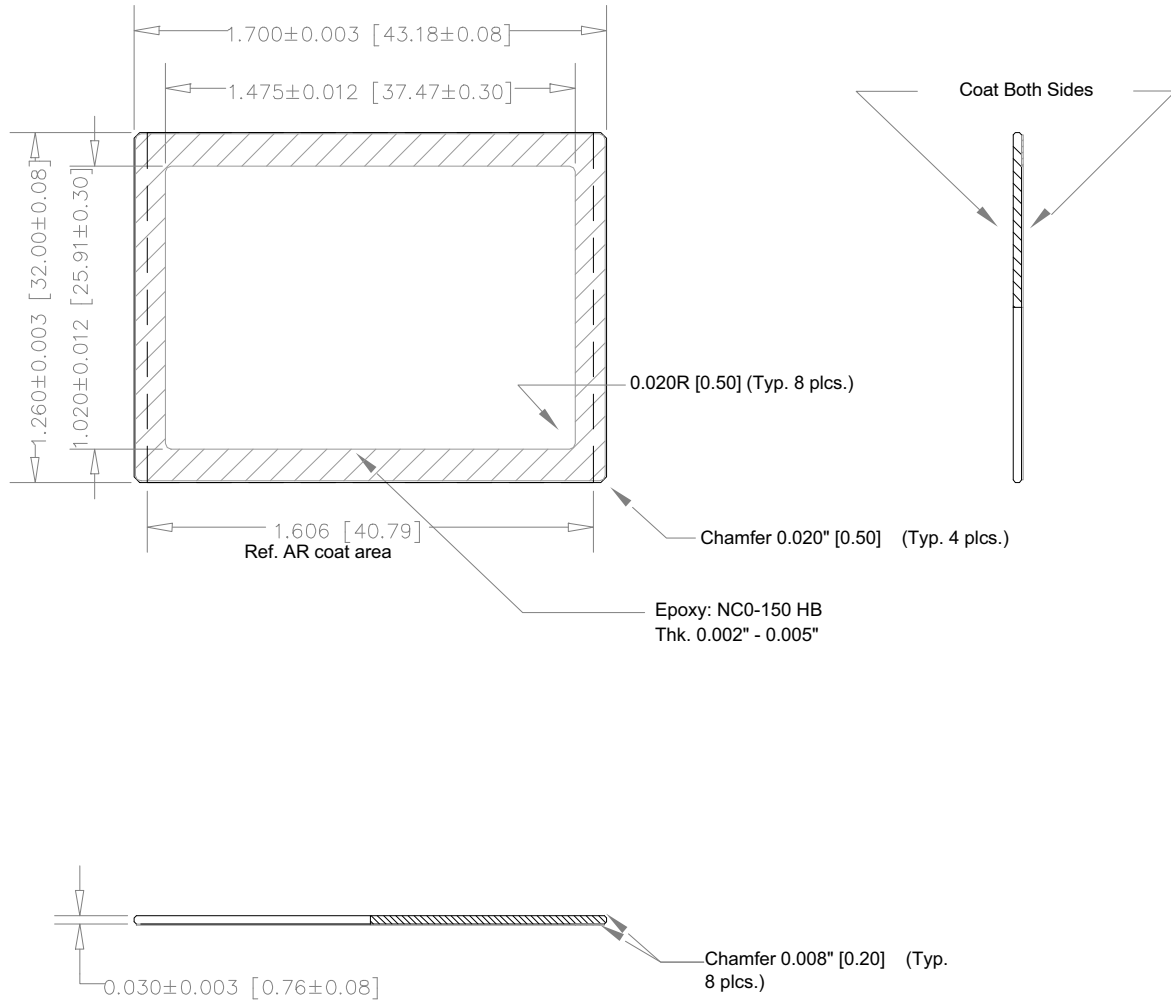

Notes:

- Multi-Layer Anti-Reflective Coating on 2 sides:  
 Double Sided Reflectance:  
 Range (nm)  
 420 - 450 nm < 2%  
 450 - 630 nm < 1%  
 630 - 680 nm < 2%
- Dust, Scratch Specification - 20 microns max
- Substrate - Schott D263T eco or Equivalent
- Epoxy: NCO-150HB  
 Thickness: 0.002" - 0.005"

Figure 22. Glass Drawing

# KAI-16000

## Glass Transmission

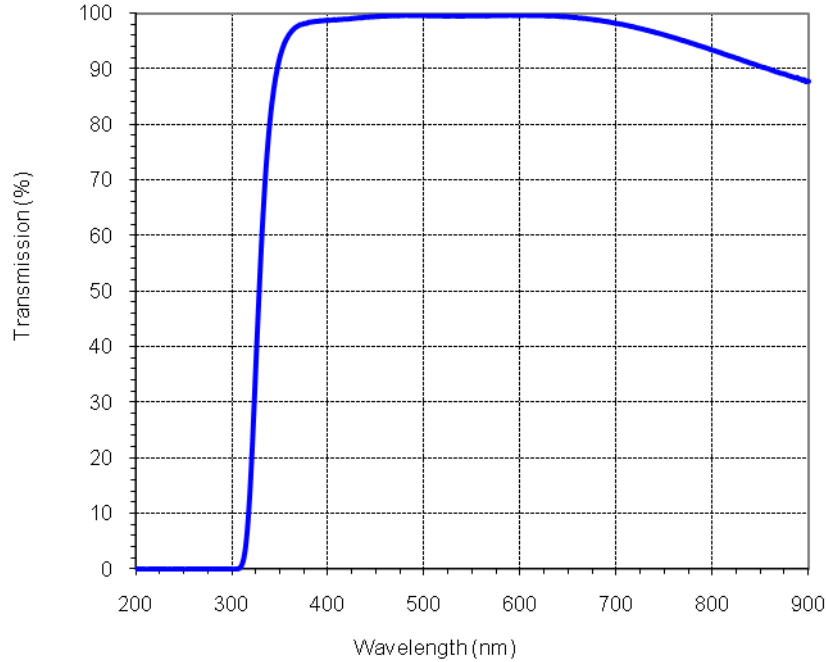

**Figure 23. Cover Glass Transmission**

ON Semiconductor and the  are registered trademarks of Semiconductor Components Industries, LLC (SCILLC) or its subsidiaries in the United States and/or other countries. SCILLC owns the rights to a number of patents, trademarks, copyrights, trade secrets, and other intellectual property. A listing of SCILLC's product/patent coverage may be accessed at [www.onsemi.com/site/pdf/Patent-Marking.pdf](http://www.onsemi.com/site/pdf/Patent-Marking.pdf). SCILLC reserves the right to make changes without further notice to any products herein. SCILLC makes no warranty, representation or guarantee regarding the suitability of its products for any particular purpose, nor does SCILLC assume any liability arising out of the application or use of any product or circuit, and specifically disclaims any and all liability, including without limitation special, consequential or incidental damages. "Typical" parameters which may be provided in SCILLC data sheets and/or specifications can and do vary in different applications and actual performance may vary over time. All operating parameters, including "Typicals" must be validated for each customer application by customer's technical experts. SCILLC does not convey any license under its patent rights nor the rights of others. SCILLC products are not designed, intended, or authorized for use as components in systems intended for surgical implant into the body, or other applications intended to support or sustain life, or for any other application in which the failure of the SCILLC product could create a situation where personal injury or death may occur. Should Buyer purchase or use SCILLC products for any such unintended or unauthorized application, Buyer shall indemnify and hold SCILLC and its officers, employees, subsidiaries, affiliates, and distributors harmless against all claims, costs, damages, and expenses, and reasonable attorney fees arising out of, directly or indirectly, any claim of personal injury or death associated with such unintended or unauthorized use, even if such claim alleges that SCILLC was negligent regarding the design or manufacture of the part. SCILLC is an Equal Opportunity/Affirmative Action Employer. This literature is subject to all applicable copyright laws and is not for resale in any manner.

### PUBLICATION ORDERING INFORMATION

**LITERATURE FULFILLMENT:**  
Literature Distribution Center for ON Semiconductor  
19521 E. 32nd Pkwy, Aurora, Colorado 80011 USA  
**Phone:** 303-675-2175 or 800-344-3860 Toll Free USA/Canada  
**Fax:** 303-675-2176 or 800-344-3867 Toll Free USA/Canada  
**Email:** [orderlit@onsemi.com](mailto:orderlit@onsemi.com)

**N. American Technical Support:** 800-282-9855 Toll Free  
USA/Canada  
**Europe, Middle East and Africa Technical Support:**  
Phone: 421 33 790 2910  
**Japan Customer Focus Center**  
Phone: 81-3-5817-1050

**ON Semiconductor Website:** [www.onsemi.com](http://www.onsemi.com)  
**Order Literature:** <http://www.onsemi.com/orderlit>  
For additional information, please contact your local  
Sales Representative