

# PRODUCT SPECIFICATION

DATE : 03/01/2005

<b>cosmo</b> ELECTRONICS CORPORATION	SOLID STATE RELAY - MOSFET OUTPUT <b>KAQW217H</b>	Preliminary	REV.
		SHEET 1 OF 7	0

## ● OUTSIDE DIMENSION :

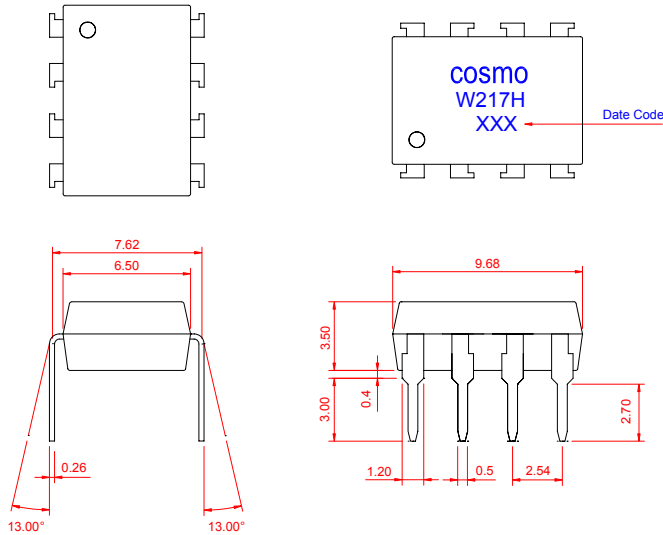

Unit : mm  
Tolerance :  $\pm 0.2$ mm

## ● Turn On / Turn Off time

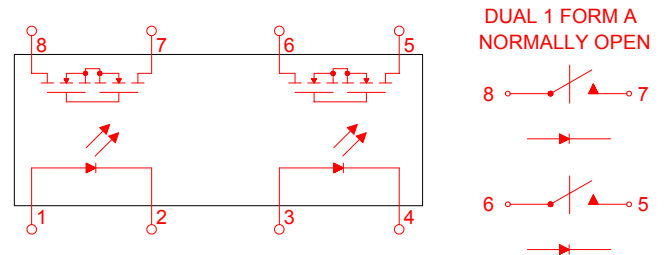
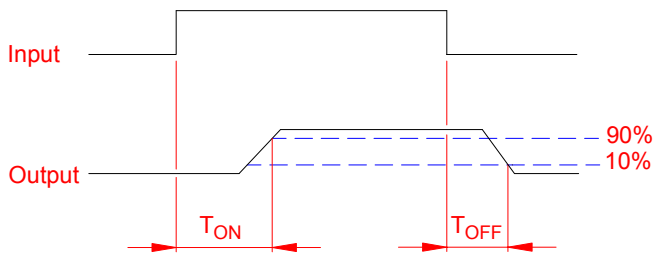

## ● Absolute Maximum Ratings

( $T_a=25^\circ\text{C}$ )

Emitter (Input)	Detector (Output)
Reverse Voltage ..... 5.0V	Output Breakdown Voltage ..... $\pm 200$ V
Continuous Forward Current ..... 50mA	Continuous Load Current ..... $\pm 180$ mA
Peak Forward Current ..... 1A	Power Dissipation ..... 500mW
Power Dissipation ..... 100mW	
Derate Linearly from $25^\circ\text{C}$ ..... $1.3\text{mW}/^\circ\text{C}$	
General Characteristics	
Isolation Test Voltage ..... 5000VACrms	Storage Temperature Range ..... $-40^\circ\text{C}$ to $+125^\circ\text{C}$
Isolation Resistance	Operating Temperature Range ... $-40^\circ\text{C}$ to $+85^\circ\text{C}$
$V_{io}=500\text{V}$ , $T_a=25^\circ\text{C}$ ..... $\geq 10^{10}\Omega$	Junction Temperature ..... $100^\circ\text{C}$
Total Power Dissipation ..... 550mW	Soldering Temperature ,
Derate Linearly from $25^\circ\text{C}$ ..... $2.5\text{mW}/^\circ\text{C}$	2mm from case , 10 sec ..... $260^\circ\text{C}$

# PRODUCT SPECIFICATION

DATE : 03/01/2005

<b>cosmo</b> ELECTRONICS CORPORATION	SOLID STATE RELAY - MOSFET OUTPUT <b>KAQW217H</b>	Preliminary	REV. 0
		SHEET 2 OF 7	

## ● Electro-optical Characteristics

(Ta=25°C)

Parameter	Symbol	Conditions	Min.	Typ.	Max.	Unit.
Emitter ( Input )						
Forward Voltage	$V_F$	$I_F=10\text{mA}$		1.2	1.5	V
Operation Input Current	$I_{F\text{ON}}$	$V_L=\pm 20\text{V}$ , $I_L=100\text{mA}$ , $t=10\text{ms}$			5.0	mA
Recovery Input Current	$I_{F\text{OFF}}$	$V_L=\pm 20\text{V}$ , $I_L \leq 5\mu\text{A}$	0.2			mA
Detector ( Output )						
Output Breakdown Voltage	$V_B$	$I_B=50\mu\text{A}$	200			V
Output Off-State Leakage	$I_{T\text{OFF}}$	$V_T=100\text{V}$ , $I_F=0\text{mA}$		0.2	1	$\mu\text{A}$
I/O Capacitance	$C_{\text{ISO}}$	$I_F=0$ , $f=1\text{MHz}$		6		pF
ON Resistance	$R_{\text{ON}}$	$I_L=100\text{mA}$ , $I_F=10\text{mA}$		6	15	$\Omega$
Turn-On Time	$T_{\text{ON}}$	$I_F=10\text{mA}$ , $V_L=\pm 20\text{V}$ $t=10\text{ms}$ , $I_L=\pm 100\text{mA}$		0.4	1.0	ms
Turn-Off Time	$T_{\text{OFF}}$			0.3	1.0	ms

## ● Schematic and Wiring Diagrams

Schematic	Output Configuration	Load	Connection	Wiring Diagrams
	2a	AC/DC	-	<p>( 1 ) Two Independent 1 Form A use</p> <p>( 2 ) 2 Form A use</p>

# PRODUCT SPECIFICATION

DATE : 03/01/2005

**cosmo**  
ELECTRONICS CORPORATION

SOLID STATE RELAY - MOSFET OUTPUT  
**KAQW217H**

Preliminary  
SHEET 3 OF 7

REV.  
0

## ● Data Curve

**Load current vs. ambient temperature**  
Allowable ambient Temperature :  
-40°C to +85°C

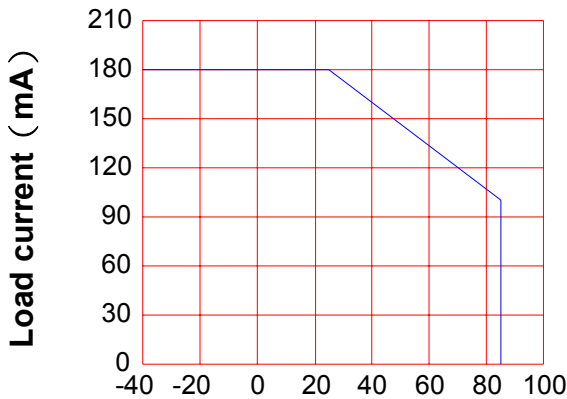

Ambient temperature Ta (°C)

**On resistance vs. ambient temperature**  
across terminals 5,7 and 6,8 pin  
LED current : 5mA  
Continuous load current : 180mA (DC)

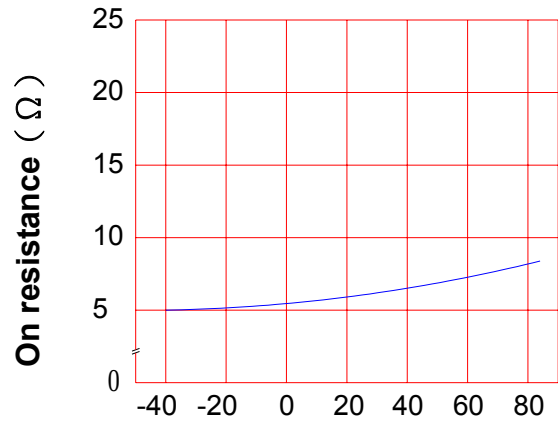

Ambient temperature Ta (°C)

**Turn On Time vs. ambient temperature**  
Load voltage 200V (DC)  
LED current : 5mA  
Continuous load current : 180mA (DC)

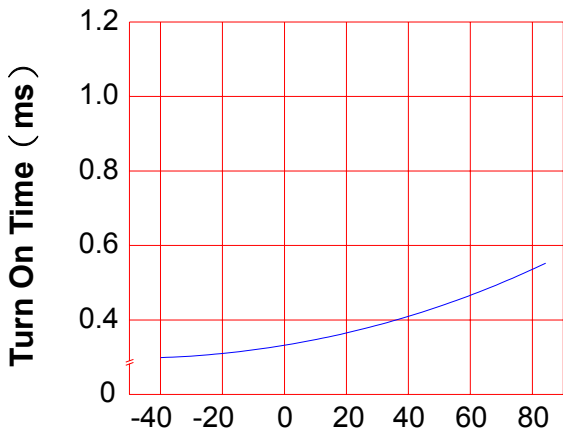

Ambient temperature Ta (°C)

**Turn Off Time vs. ambient temperature**  
Load voltage 200V (DC)  
LED current : 5mA  
Continuous load current : 180mA (DC)

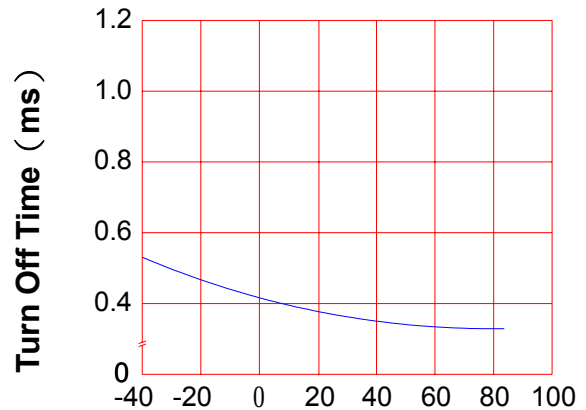

Ambient temperature Ta (°C)

# PRODUCT SPECIFICATION

DATE : 03/01/2005

<b>cosmo</b> ELECTRONICS CORPORATION	SOLID STATE RELAY - MOSFET OUTPUT <b>KAQW217H</b>	Preliminary	REV.
		SHEET 4 OF 7	0

LED operate current vs.  
ambient temperature

Load Voltage : 200V (DC)

Continuous load current : 180mA (DC)

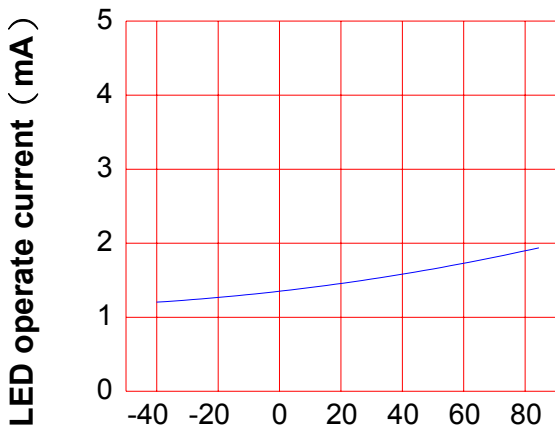

Ambient temperature Ta (°C)

LED Turn Off current vs.  
ambient temperature

Load Voltage : 200V (DC)

Continuous load current : 180mA (DC)

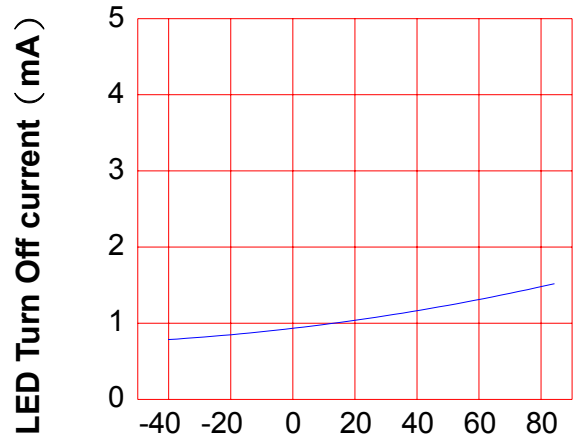

Ambient temperature Ta (°C)

LED dropout voltage vs.  
ambient temperature

LED current : 5 to 50mA

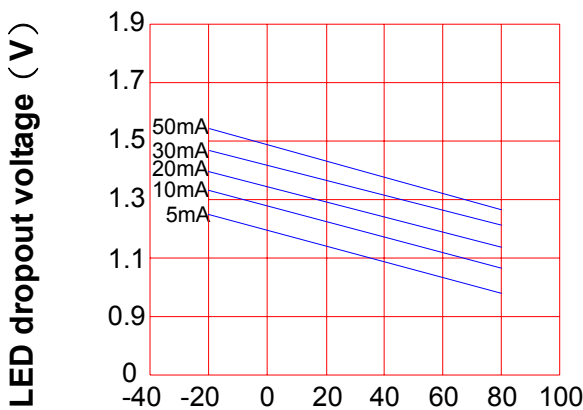

Ambient temperature Ta (°C)

Voltage vs. current characteristics  
of output at MOSFET portion

Measured portion : across terminals  
5,7 and 6,8 pin

Ambient temperature : 25°C

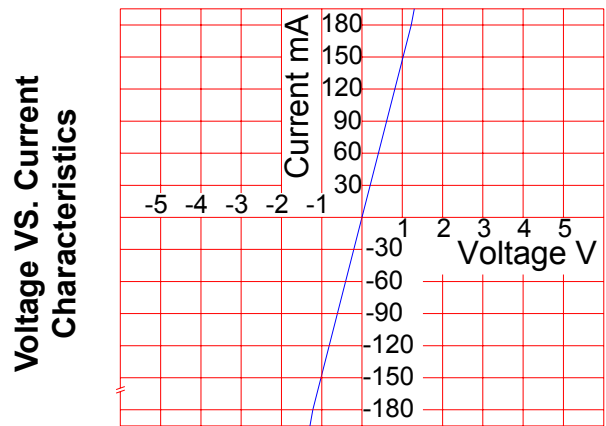

Ambient temperature : 25°C

# PRODUCT SPECIFICATION

**LED forward current vs. Turn On Time**

Across terminals 5,7 and 6,8 pin

Load voltage : 200V (DC)

Continuous load current : 180mA (DC)

Ambient temperature : 25°C

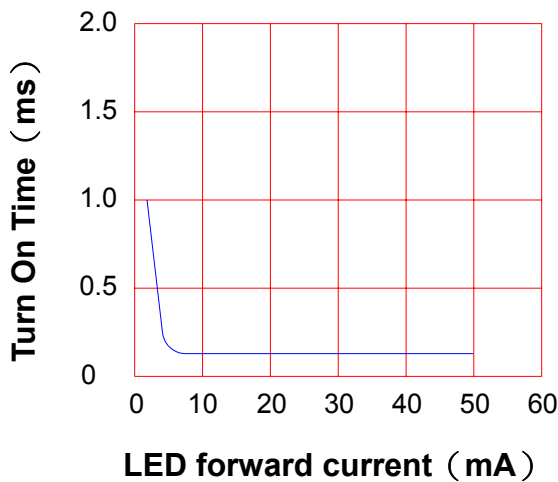

**Off state leakage current**

Across terminals 5,7 and 6,8 pin

Ambient temperature : 25°C

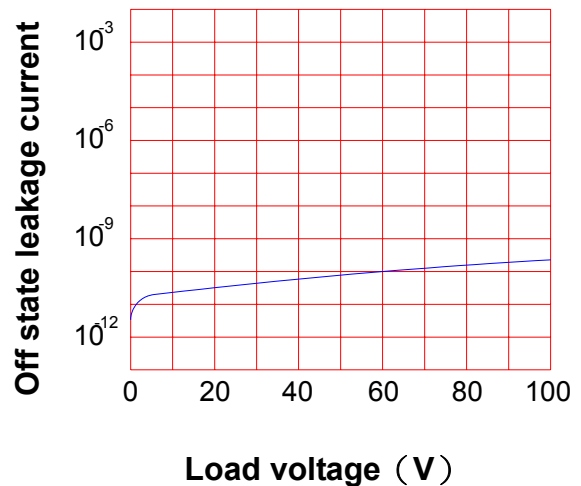

**LED forward current vs. reverse(ON) time**

Across terminals 5,7 and 6,8 pin

Load voltage : 200V (DC)

Continuous load current : 180mA (DC)

Ambient temperature : 25°C

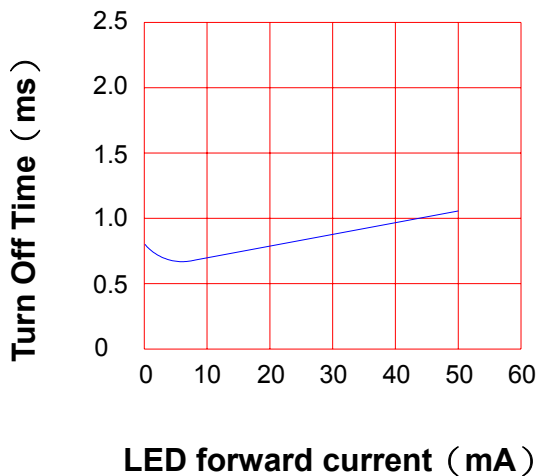

**Applied voltage vs. output capacitance**

Across terminals 5,7 and 6,8 pin

Frequency : 1MHz

Ambient temperature : 25°C

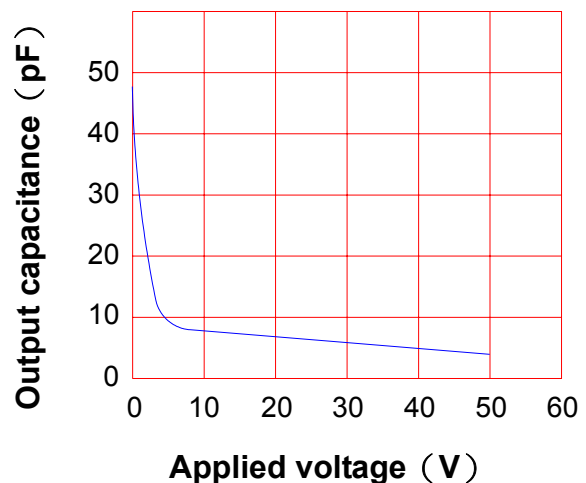

## ● USING METHODS

Examples of resistance value to control LED forward current ( $I_F$ )

SSR-MOSFET OUTPUT

( $I_F=5\text{mA}$ )

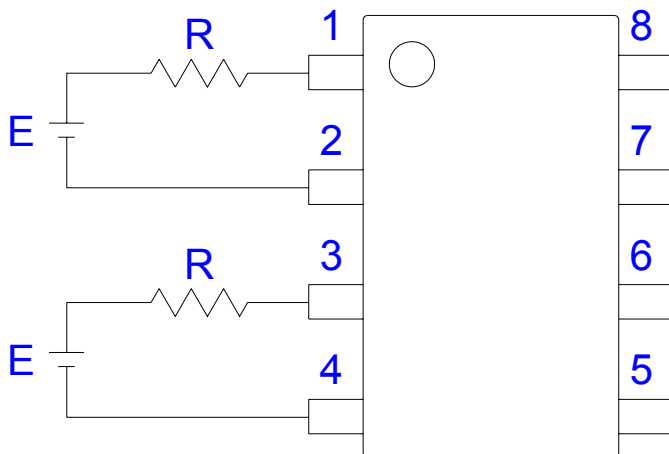

E	R
3.3V	Approx. 330 $\Omega$
5V	Approx. 640 $\Omega$
12V	Approx. 1.9K $\Omega$
15V	Approx. 2.5K $\Omega$
24V	Approx. 4.1K $\Omega$

- (1) LED forward current must be more than 5mA , at E min.
- (2) LED forward current must be less than 50mA , at E max.

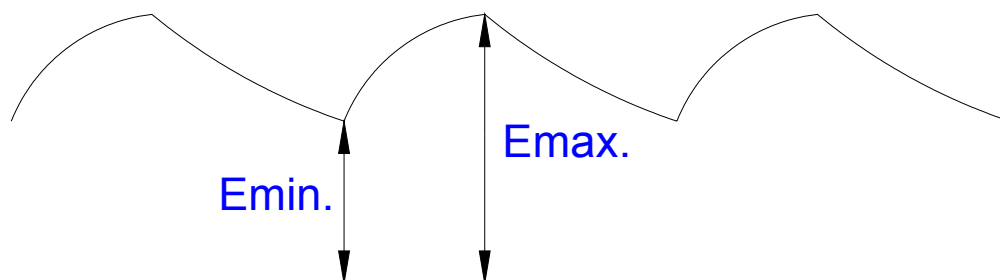

## ● USING METHODS

Regulate the spike voltage generated on the inductive load as follows :

