

### KB354NT

#### Features

- 1.AC inputs.
- 2.High current transfer ratio.
- 2.Opaque type, mini-flat package.
- 3.Subminiature type (The volume is smaller than that of our conventional DIP type by as far as 30%).
- 4.Isolation voltage between input and output Viso:3750Vrms.
- 5.Emloys double transfer mold technology.
- 6.Recognized by UL and CUL, file NO.E225308.
- 7.Package : 1000Pcs / Reel.
- 8.RoHS Compliant.

#### Applications

- 1.Hybrid substrates that require high density mounting.
- 2.Programmable controllers.

#### \*PACKAGE DIMENSIONS (UNIT:mm)

##### SMD Type

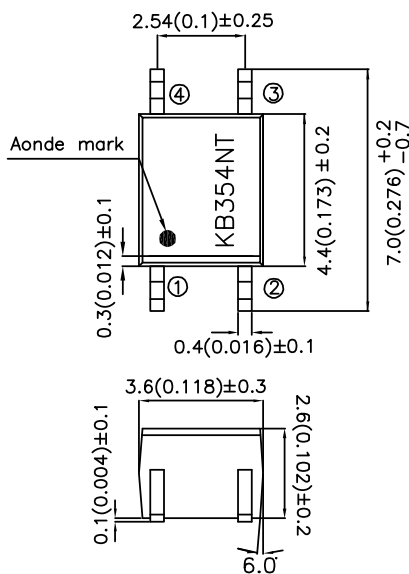

#### Internal connection diagram

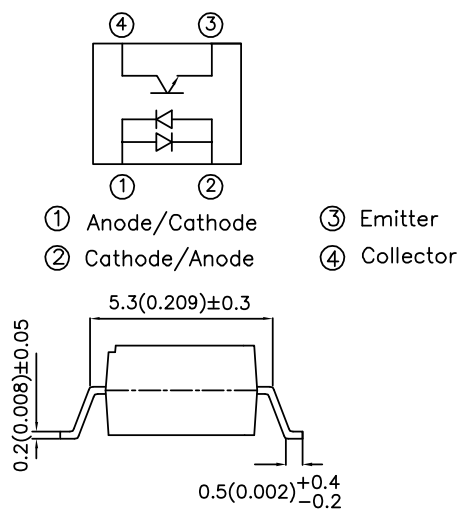

UNIT : MM[INCH]  
 TOLERANCE : ±0.5[±0.02] UNLESS OTHERWISE NOTED.

#### \*Absolute Maximum Ratings (Ta=25°C)

Parameter		Symbol	Rating	Unit
Input	Forward current	IF	±50	mA
	Power dissipation	P	70	mW
Output	Collector-emitter voltage	VCEO	35	V
	Emitter-collector voltage	VECO	6	V
	Collector current	IC	50	mA
	Collector power dissipation	PC	150	mW
Total power dissipation		P tot	170	mW
*1 Isolation voltage		V iso	3750	Vrms
Operating temperature		T opr	-30 to +100	°C
Storage temperature		T stg	-55 to +125	°C
*2 Soldering temperature		T sol	260	°C

\*1 40 to 60%RH, AC for 1 minute.

\*2 For 10 seconds.

#### \*Electro-optical Characteristics

Parameter		Symbol	Conditions	Min.	Typ.	Max.	Unit	
Input	Forward voltage	VF	IF=± 20mA	-	1.2	1.4	V	
	Peak forward voltage	VFM	IFM=0.5A	-	-	3.0	V	
Output	Collector dark current	ICEO	Vce=20V IF=0	-	-	10 <sup>-7</sup>	A	
	Collector-emitter breakdown voltage	BVCEO	IC=0.1mA IF=0	35	-	-	V	
	Emitter-collector breakdown voltage	BVECO	IE=10uA IF=0	6	-	-	V	
Transfer characteristics	Current transfer ration		CTR	IF=± 1mA Vce=5V	20	-	400	%
	Collector-emitter saturation voltage		VCE (sat)	IF=± 20mA IC=1mA	-	0.1	0.2	V
	Response time	Rise time	tr	Vce=2V IC=2mA RL=100Ω	-	4	18	uS
		Fall time	tr		-	3	18	uS

Model No.	Rank mark	CTR(%)
KB354N1T	A	50 to 150
KB354NT	A or No mark	20 to 400

**Fig. 1 Current Transfer vs. Forward Current**

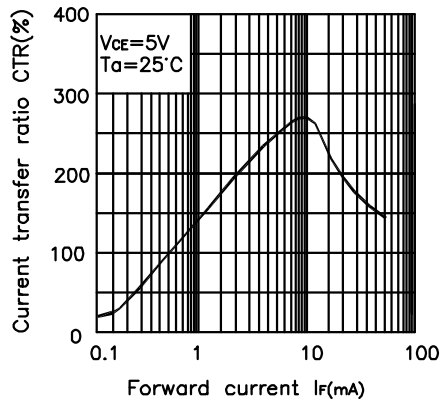

**Fig. 2 Forward Current vs. Forward voltage**

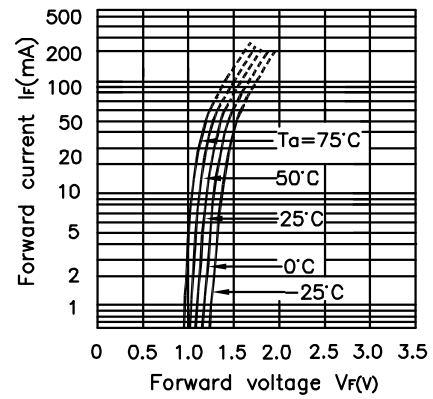

**Fig. 3 Collector Current vs. Collector-emitter Voltage**

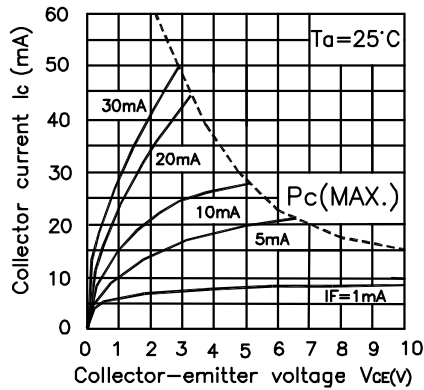

**Fig. 4 Forward Current vs. Ambient Temperature**

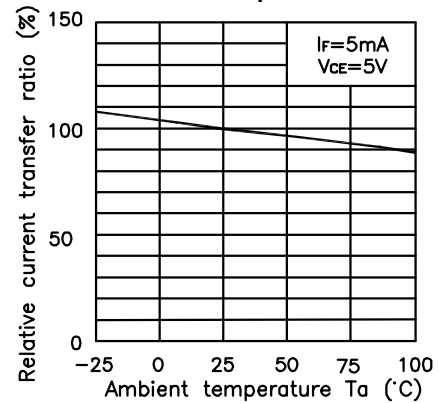

**Fig. 5 Collector-emitter Saturation Voltage vs. Ambient Temperature**

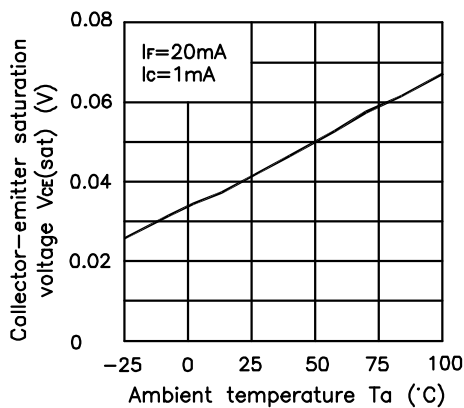

**Fig. 6 Response Time vs. Load Resistance**

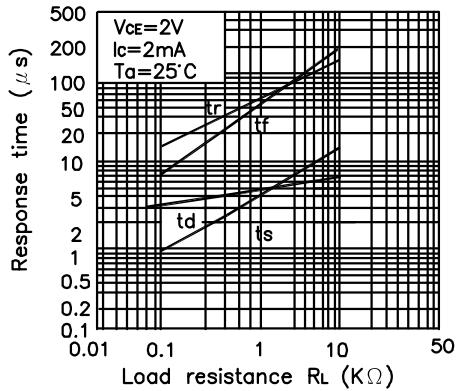

**Test Circuit for Response Time**

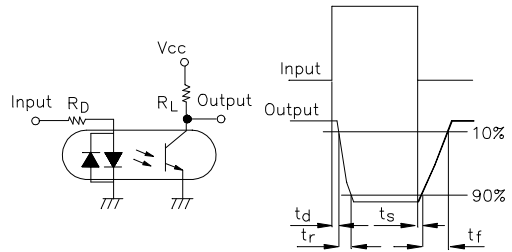

**Fig. 7 Collector-emitter Saturation Voltage vs. Forward Current**

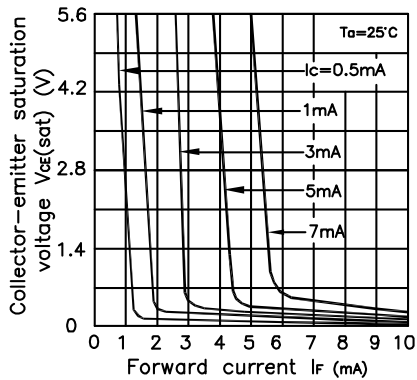

**Fig. 8 Collector Dark Current vs. Ambient Temperature**

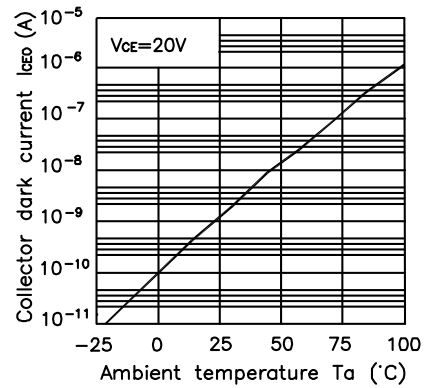

#### \* NOTES ON HANDLING

#### 1.Recommended soldering conditions (Dip soldering)

##### (1) Dip soldering

Temperature	260°C or below (molten solder temperature)
Time	Less than 10 seconds.
Cycle	One cycle allowed to be dipped in solder including plastic mold portion.
Flux	Rosin flux containing small amount of chlorine (The flux with a maximum chlorine content of 0.2 Wt % is recommended.)

##### (2) Cautions

###### Fluxes

Avoid removing the residual flux with freon-based and chlorine-based cleaning solvent.

#### 2.Cautions regarding noise

Be aware that power is suddenly into the component any surge current may cause damage happen, even if the voltage is within the absolute maximum ratings.

#### NOTES ON HANDLING

##### 1.Recommended soldering conditions

###### (1).Infrared reflow soldering

- Peak reflow temperature 235 ° C or below(package surface temperature)
- Time of temperature higher than 210 ° C 30 seconds or less
- Number of reflows Three
- Flux Rosin flux containing small amount of chlorine(The flux with a maximum chlorine content of 0.2Wt % is recommended.)

Recommended Temperature Profile of infrared Reflow

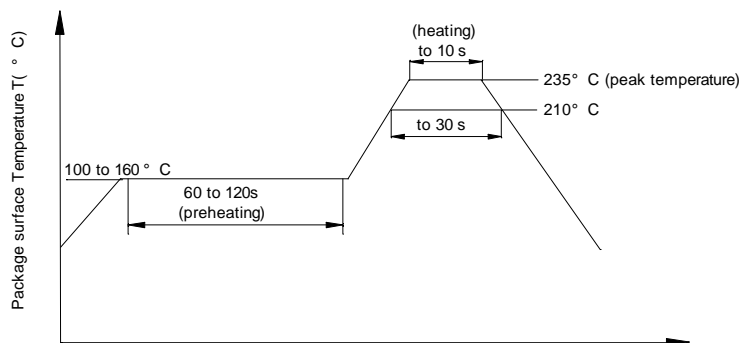

#### CAUTION

Within this device there exists GaAs (Gallium Arsenide) material which is a harmful substance if ingested. GaAs dust and fumes are toxic. Do not break, cut or pulverize the product, or use chemicals to dissolve them.

#### RESTRICTIONS ON PRODUCT USE

- The information in this document is subject to change without notice. Before using this document, please confirm that this is the latest version. Not all devices / types available in every country.
- We mention about our product quality stability, semiconductor devices in general can malfunction or fail due to their inherent electrical sensitivity and vulnerability to physical stress. It is the responsibility of the buyer, when utilizing KINGBRIGHT products, to observe standards of safety, and to avoid situations in which a malfunction or failure of a KINGBRIGHT product could cause loss of human life, bodily injury or damage to property. In developing your designs, please ensure that KINGBRIGHT products are used within specified operating ranges as set forth in the most recent products specifications.

### KB354NT

#### Outline and Dimension(Tape) (Units : mm)

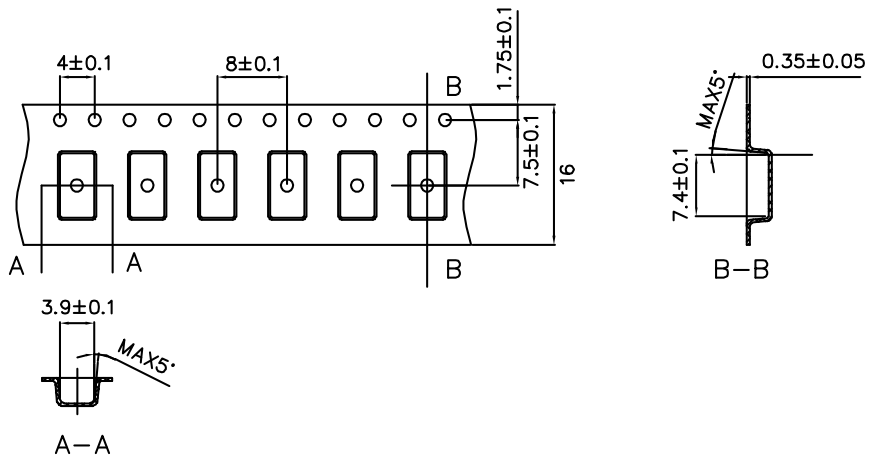

#### Tape Direction

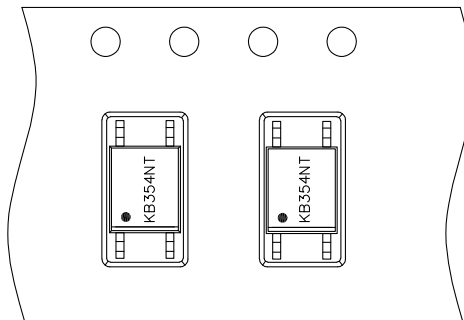

#### Outline and Dimension(Reel)

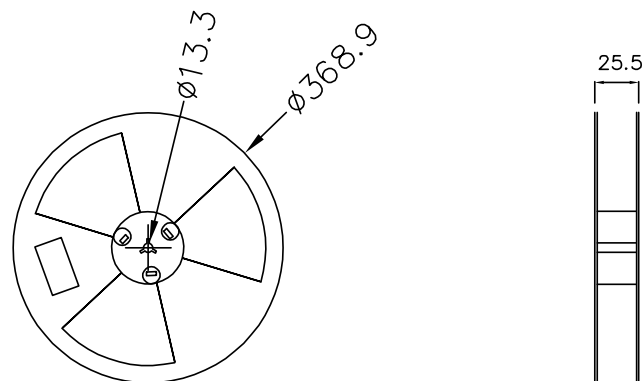

Packing: 1000pcs/reel