

# Kingtronics®

# KBPC15005 THRU KBPC1510

## SINGLE-PHASE BRIDGE RECTIFIER

REVERSE VOLTAGE 50 to 1000 Volts      FORWARD CURRENT 15.0 Ampere

### FEATURES

High forward surge current capability  
 Low thermal resistance  
 High isolation voltage from case to leads  
 High temperature soldering guaranteed:  
 260°C /10 second, at 5 lbs. (2.3kg) tension.

### MECHANICAL DATA

Case: Metal case  
 Terminal: Plated 0.25" (6.35mm) lug  
 Polarity: Polarity symbols molded on case  
 Mounting: Thru hole for #10 screw, 20 in,- lbs. Torque Max  
 Weight: 1.02 ounce, 29 gram

### MAXIMUM RATINGS AND ELECTRICAL CHARACTERISTICS

Ratings at 25°C ambient temperature unless otherwise specified ,  
 Single phase, half wave, 60Hz, resistive or inductive load.  
 For capacitive load derate current by 20%

Dimensions in inches and (millimeters)

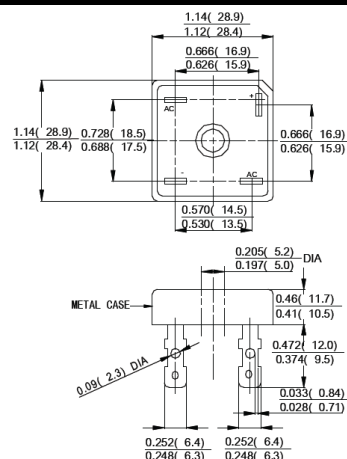

PARAMETER	SYMBOL	KBPC 15005	KBPC 1501	KBPC 1502	KBPC 1504	KBPC 1506	KBPC 1508	KBPC 1510	UNIT
Maximum Repetitive Peak Reverse Voltage	$V_{RRM}$	50	100	200	400	600	800	1000	Volts
Maximum RMS Voltage	$V_{RRM}$	35	70	140	280	420	560	700	Volts
Maximum DC Blocking Voltage	$V_{DC}$	50	100	200	400	600	800	1000	Volts
Maximum Average Forward Rectified Output Current, at $T_C=50^\circ C$ (Note 1,2)	$I_{(VA)}$	15							Amps
Peak Forward Surge Current 8.3ms Single half sine-wave superimposed on rated load (JEDEC Method)	$I_{FSM}$	300							Amps
Rating for Fusing ( $t < 8.3ms$ )	$I^2t$	373							A <sup>2</sup> S
Maximum Instantaneous Forward Voltage at 7.5A	$V_F$	1.1							Volts
Maximum DC Reverse Current at rated DC blocking voltage	$T_A=25^\circ C$	5.0							uAmps
	$T_A=125^\circ C$	0.5							mAmps
Isolation Voltage from case to lugs	$V_{ISO}$	2500							$V_{AC}$
Typical Thermal Resistance (Note 1,2)	$R_{\theta JC}$	2.0							$^\circ C/W$
Operating Temperature Range	$T_J$	-65 to +150							$^\circ C$
Storage Temperature Range	$T_{STG}$	-65 to +150							$^\circ C$

- Unit mounted on 9"×3.5"×4.6" (23×9×11.8mm) Al. finned plate.
- Bolt down on heat-sink with silicone thermal compound between bridge and mounting surface for maximum heat transfer efficiency with #10 screw.

**Kingtronics® International Company**

# Kingtronics®

# KBPC15005 THRU KBPC1510

## RATINGS AND CHARACTERISTIC CURVES

FIG.1-DERATING CURVE FOR  
OUTPUT RECTIFIED CURRENT

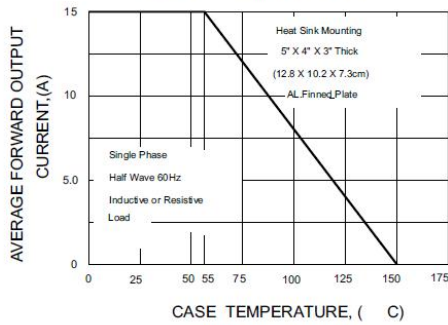

FIG.2-MAXIMUM NON-REPETITIVE PEAK  
FORWARD SURGE CURRENT PER ELEMENT

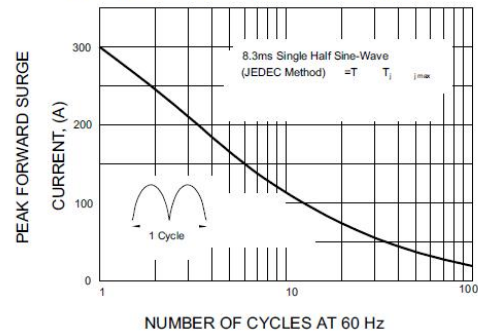

FIG.3-TYPICAL FORWARD CHARACTERISTICS  
PER BRIDGE ELEMENT

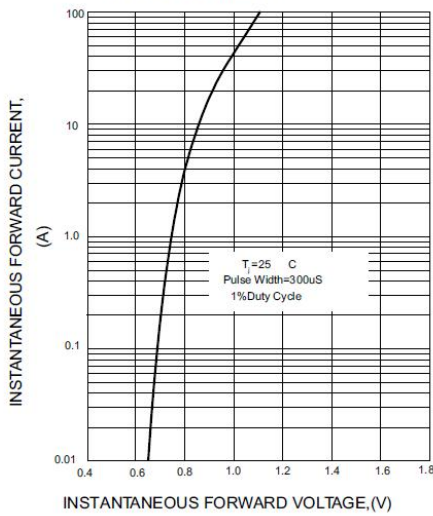

FIG.4-TYPICAL REVERSE CHARACTERISTICS  
PER BRIDGE ELEMENT

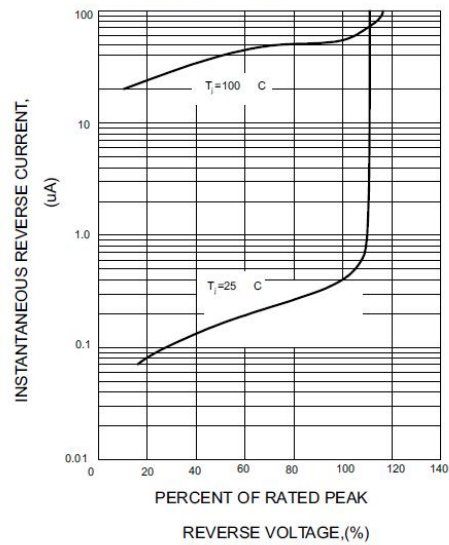

FIG.5-TYPICAL JUNCTION CAPACITANCE  
PER BRIDGE ELEMENT

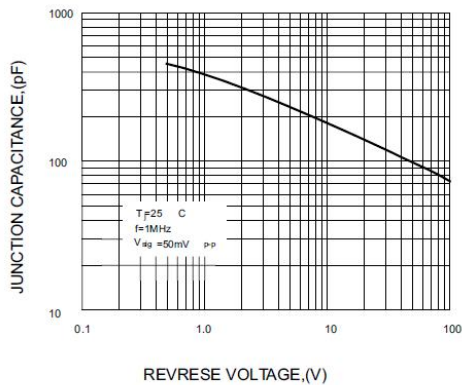
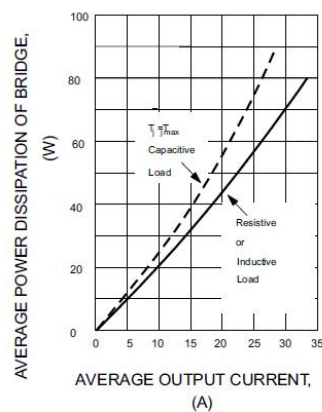

FIG.6-MAXIMUM POWER DISSIPATION



Note: Specifications are subject to change without notice.

**Kingtronics® International Company**