

General Description

This planar stripe MOSFET has better characteristics, such as fast switching time, low on resistance, low gate charge and excellent avalanche characteristics. It is mainly suitable for electronic ballast and switching mode power supplies.

FEATURES

- $V_{DSS} = 500V$, $I_D = 13A$
- Drain-Source ON Resistance :
 $R_{DS(ON)} = 0.44$ (Max) @ $V_{GS} = 10V$
- Q_g (typ.) = 35nC

MAXIMUM RATING (Tc=25 °C)

CHARACTERISTIC	SYMBOL	RATING		UNIT
		KF13N50P	KF13N50F	
Drain-Source Voltage	V_{DSS}	500		V
Gate-Source Voltage	V_{GSS}	± 30		V
Drain Current	@Tc=25	13	13*	A
	@Tc=100	8	8*	
	Pulsed (Note1)	I_{DP}	40	
Single Pulsed Avalanche Energy (Note 2)	E_{AS}	860		mJ
Repetitive Avalanche Energy (Note 1)	E_{AR}	19.5		mJ
Peak Diode Recovery dv/dt (Note 3)	dv/dt	4.5		V/ns
Drain Power Dissipation	Tc=25	208	49.8	W
	Derate above 25	1.66	0.4	W/
Maximum Junction Temperature	T_j	150		
Storage Temperature Range	T_{stg}	-55 150		
Thermal Characteristics				
Thermal Resistance, Junction-to-Case	R_{thJC}	0.6	2.51	/W
Thermal Resistance, Junction-to-Ambient	R_{thJA}	62.5	62.5	/W

* : Drain current limited by maximum junction temperature.

EQUIVALENT CIRCUIT

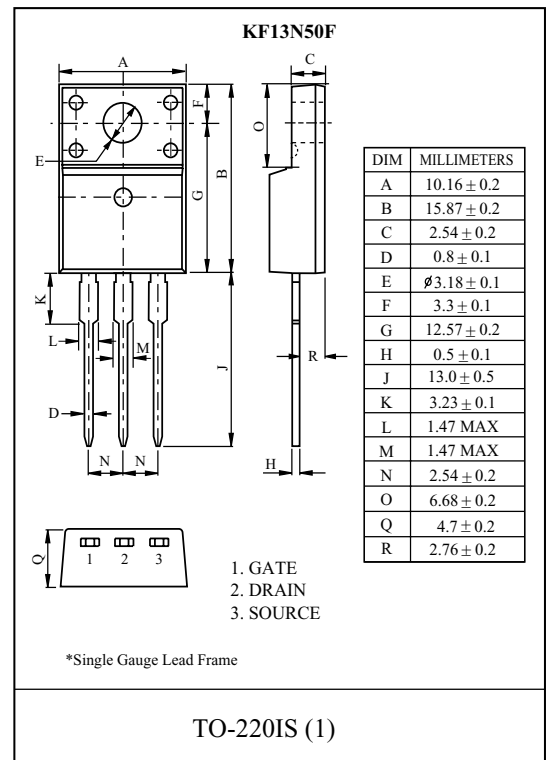
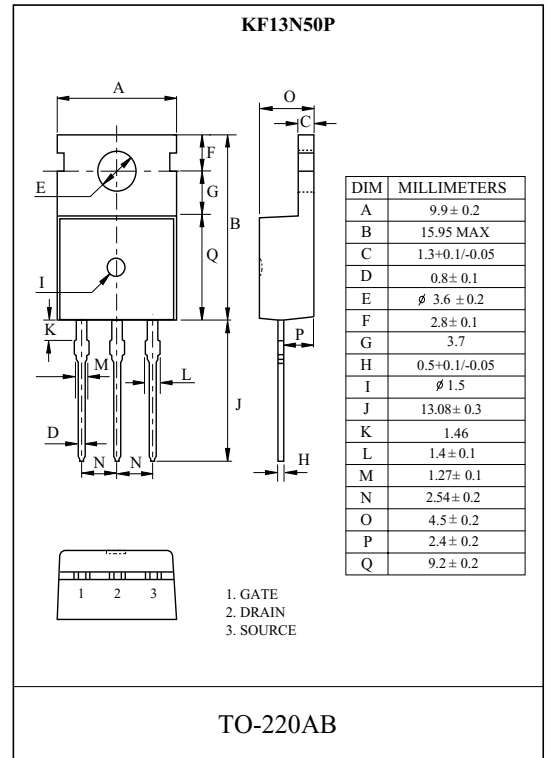
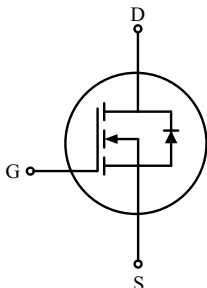

KF13N50P/F

ELECTRICAL CHARACTERISTICS (Tc=25)

CHARACTERISTIC	SYMBOL	TEST CONDITION	MIN.	TYP.	MAX.	UNIT
Static						
Drain-Source Breakdown Voltage	BV_{DSS}	$I_D=250\ \mu A, V_{GS}=0V$	500	-	-	V
Breakdown Voltage Temperature Coefficient	BV_{DSS}/T_j	$I_D=250\ \mu A$, Referenced to 25	-	0.63	-	V/
Drain Cut-off Current	I_{DSS}	$V_{DS}=500V, V_{GS}=0V$,	-	-	10	μA
Gate Threshold Voltage	V_{th}	$V_{DS}=V_{GS}, I_D=250\ \mu A$	2.5	-	4.5	V
Gate Leakage Current	I_{GSS}	$V_{GS}=\pm 30V, V_{DS}=0V$	-	-	± 100	nA
Drain-Source ON Resistance	$R_{DS(ON)}$	$V_{GS}=10V, I_D=6.5A$	-	0.35	0.44	
Dynamic						
Total Gate Charge	Q_g	$V_{DS}=400V, I_D=13A$ $V_{GS}=10V$ (Note4,5)	-	35	-	nC
Gate-Source Charge	Q_{gs}		-	9	-	
Gate-Drain Charge	Q_{gd}		-	13	-	
Turn-on Delay time	$t_{d(on)}$	$V_{DD}=250V$ $I_D=13A$ $R_G=25$ (Note4,5)	-	28	-	ns
Turn-on Rise time	t_r		-	45	-	
Turn-off Delay time	$t_{d(off)}$		-	105	-	
Turn-off Fall time	t_f		-	55	-	
Input Capacitance	C_{iss}	$V_{DS}=25V, V_{GS}=0V, f=1.0MHz$	-	1700	-	pF
Output Capacitance	C_{oss}		-	210	-	
Reverse Transfer Capacitance	C_{rss}		-	15	-	
Source-Drain Diode Ratings						
Continuous Source Current	I_S	$V_{GS}<V_{th}$	-	-	13	A
Pulsed Source Current	I_{SP}		-	-	52	
Diode Forward Voltage	V_{SD}	$I_S=13A, V_{GS}=0V$	-	-	1.4	V
Reverse Recovery Time	t_{rr}	$I_S=13A, V_{GS}=0V$, $dI_S/dt=100A/\mu s$	-	360	-	ns
Reverse Recovery Charge	Q_{rr}		-	4.4	-	μC

Note 1) Repetivity rating : Pulse width limited by junction temperature.

Note 2) L=6.0mH, $I_S=13A$, $V_{DD}=50V$, $R_G=25$, Starting $T_j=25$.

Note 3) I_S 13A, dI/dt 200A/ μs , V_{DD} BV_{DSS} , Starting $T_j=25$.

Note 4) Pulse Test : Pulse width 300 μs , Duty Cycle 2%.

Note 5) Essentially independent of operating temperature.

Marking

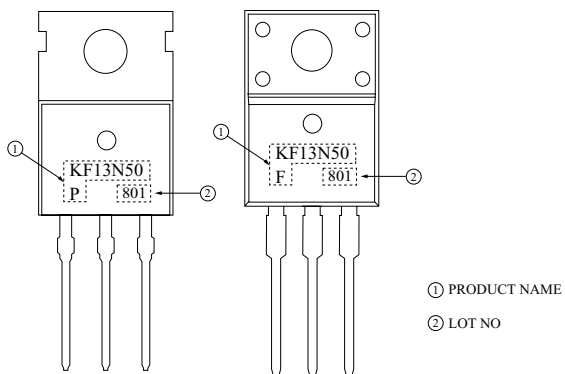

KF13N50P/F

Fig1. $I_D - V_{DS}$

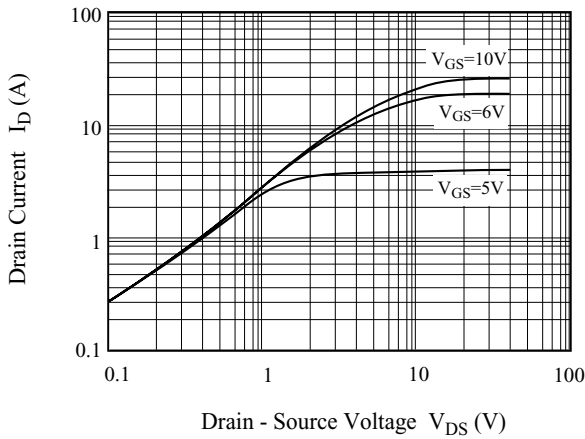

Fig2. $I_D - V_{GS}$

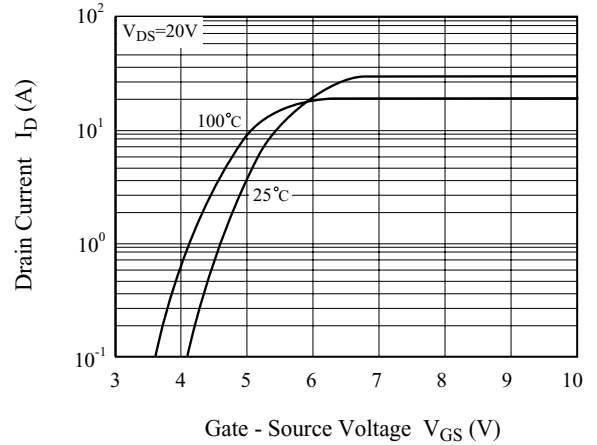

Fig3. $BV_{DSS} - T_j$

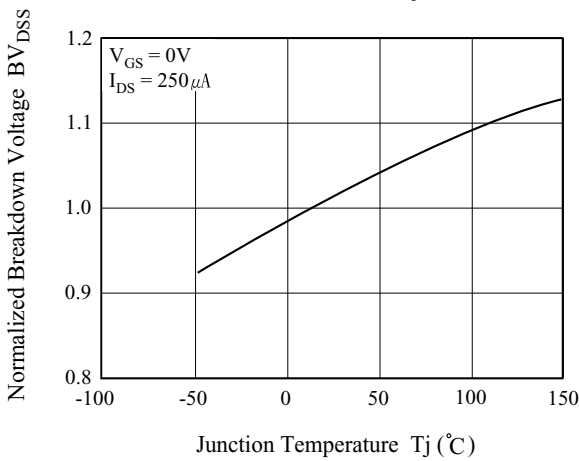

Fig4. $R_{DS(ON)} - I_D$

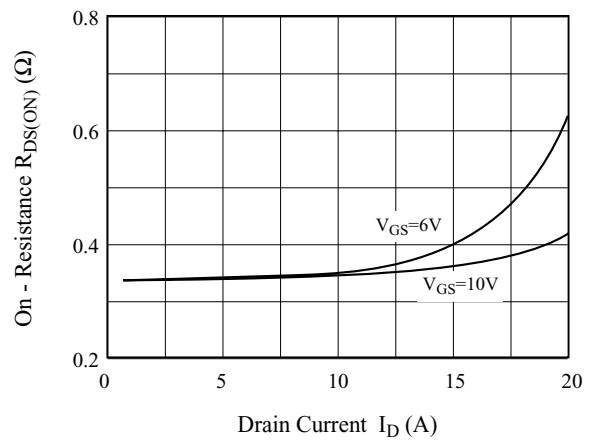

Fig5. $I_S - V_{SD}$

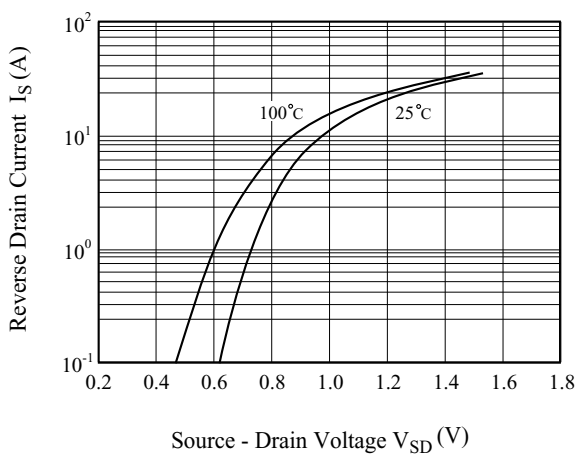
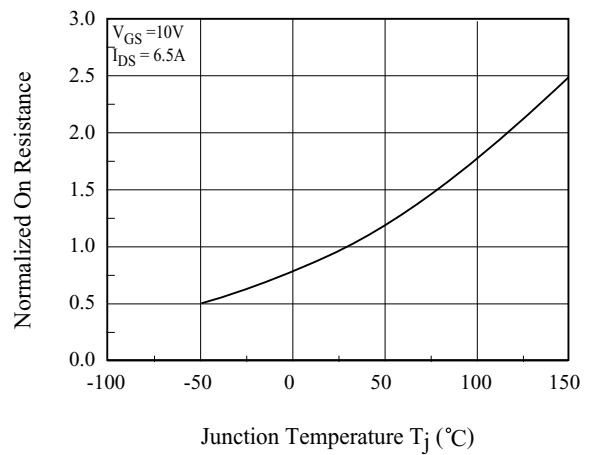

Fig6. $R_{DS(ON)} - T_j$



KF13N50P/F

Fig 7. C - V_{DS}

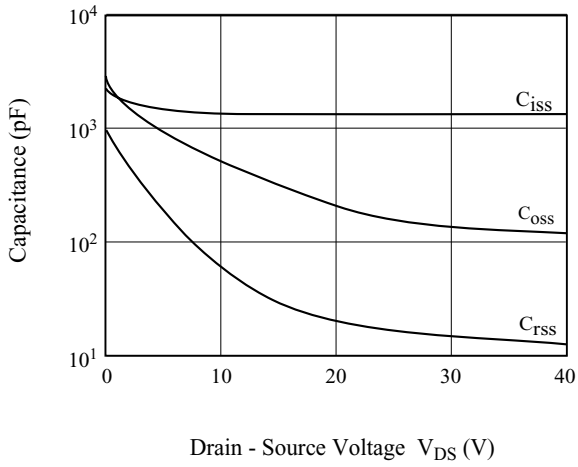

Fig8. Q_g- V_{GS}

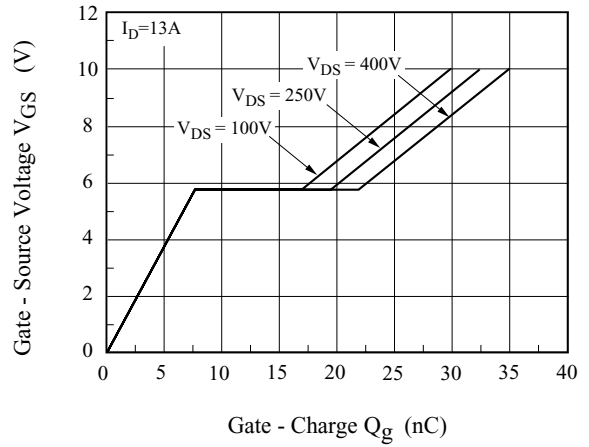

Fig9. Safe Operation Area

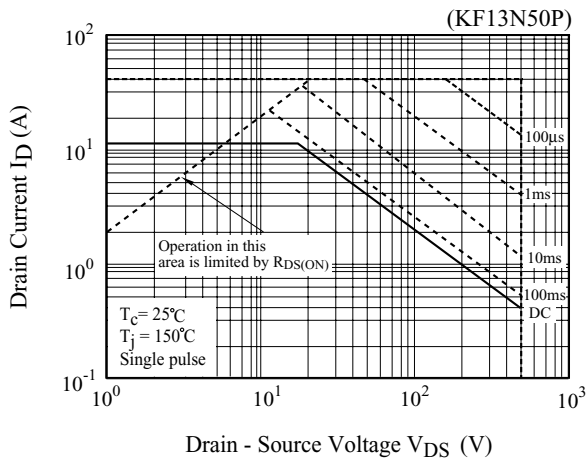

Fig10. Safe Operation Area

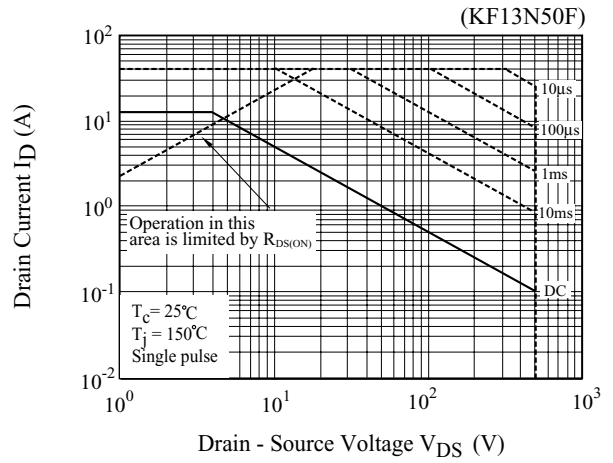
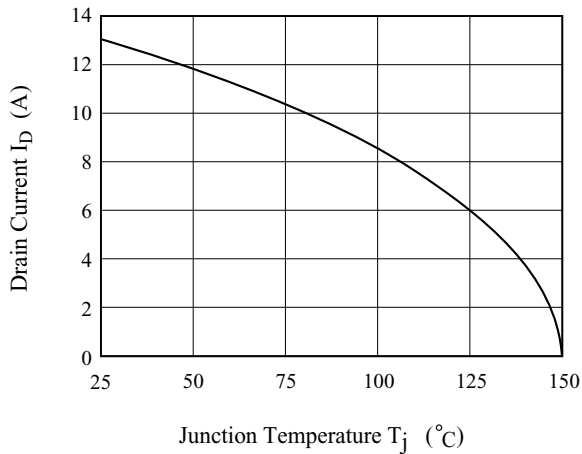

Fig11. I_D - T_j



KF13N50P/F

Fig12. Transient Thermal Response Curve

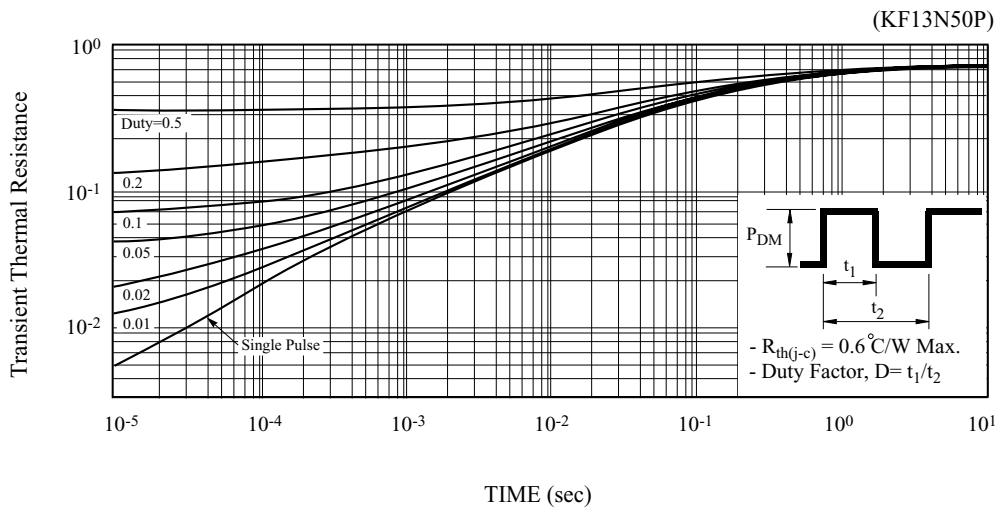

Fig13. Transient Thermal Response Curve

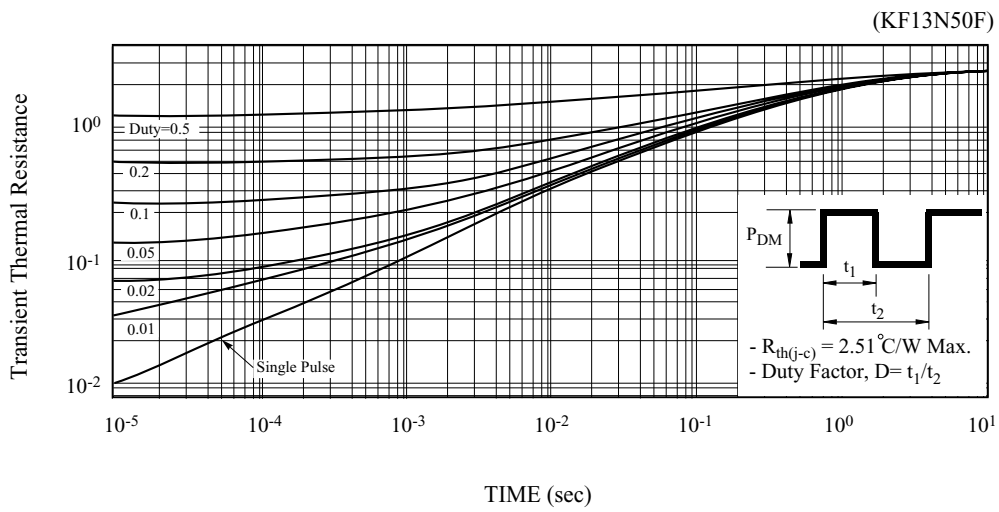

Fig14. Gate Charge

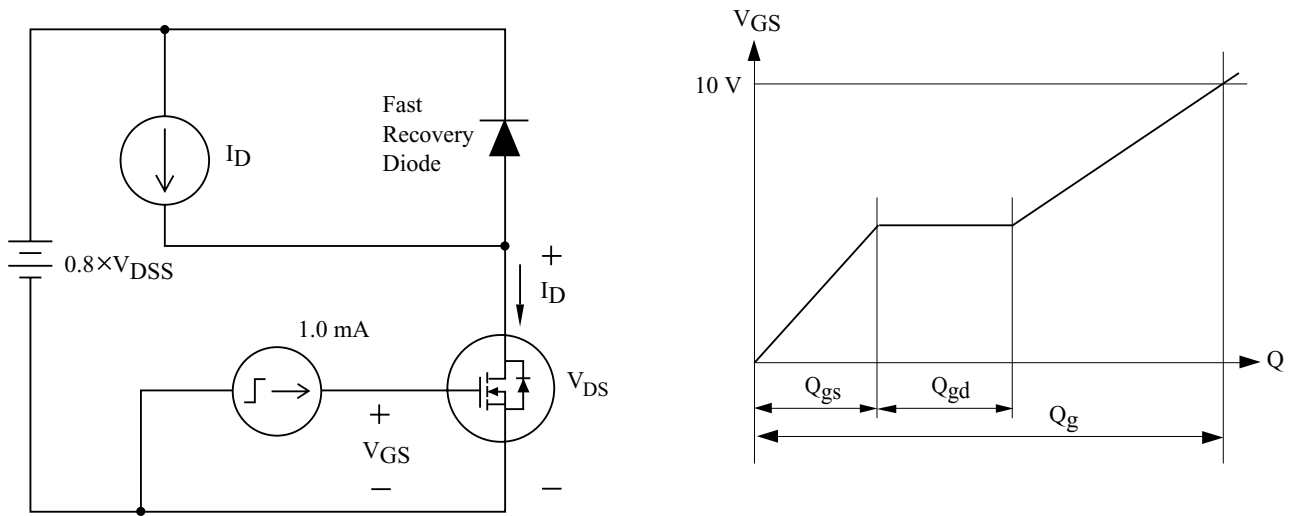

Fig15. Single Pulsed Avalanche Energy

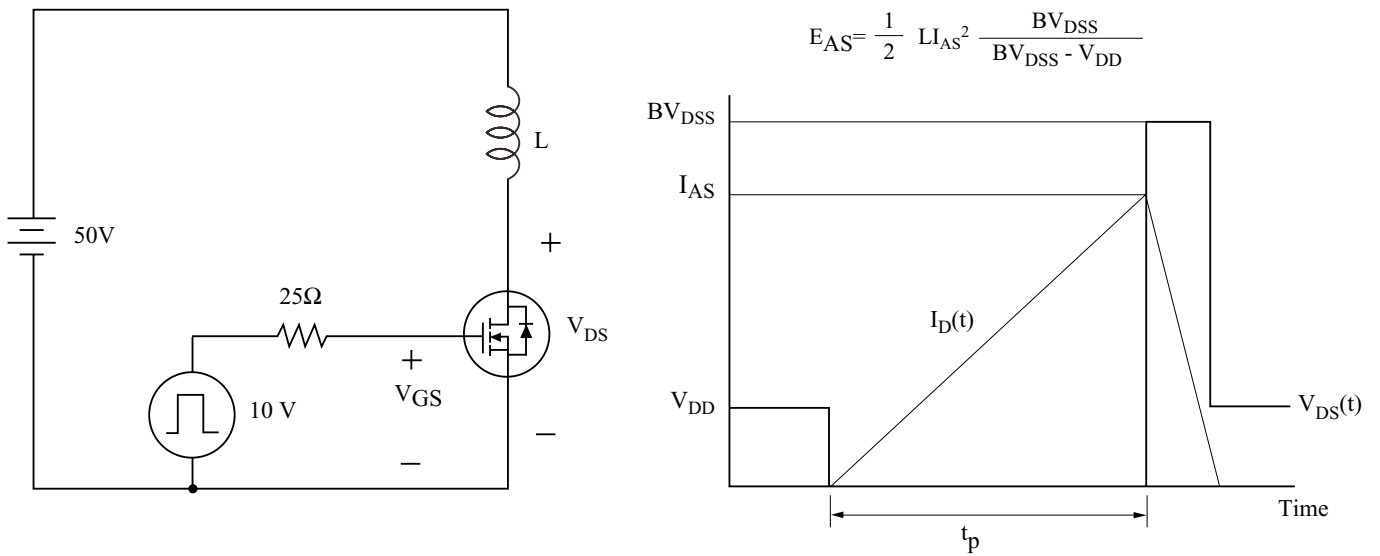

Fig16. Resistive Load Switching

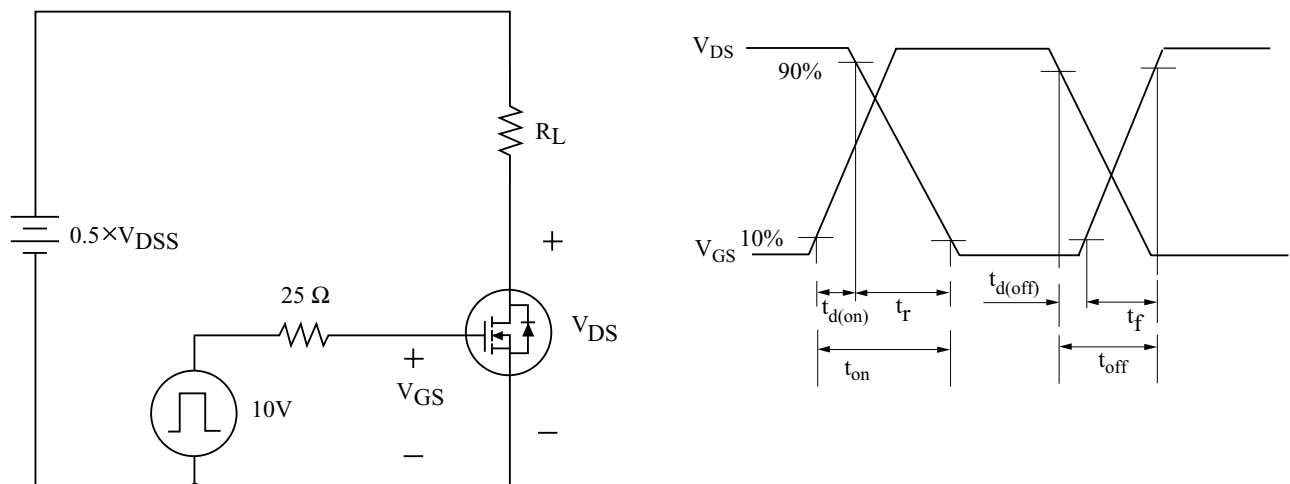

Fig17. Source - Drain Diode Reverse Recovery and dv/dt

