

### General Description

This planar stripe MOSFET has better characteristics, such as fast switching time, low on resistance, low gate charge and excellent avalanche characteristics. It is mainly suitable for active power factor correction and switching mode power supplies.

### FEATURES

- $V_{DSS}=600V$ ,  $I_D=8A$
- Drain-Source ON Resistance :  
 $R_{DS(ON)}(Max)=1.05$  @  $V_{GS}=10V$
- $Q_g(typ.)=22nC$

### MAXIMUM RATING (Tc=25 °C)

CHARACTERISTIC	SYMBOL	RATING		UNIT
		KF8N60P	KF8N60F	
Drain-Source Voltage	$V_{DSS}$	600		V
Gate-Source Voltage	$V_{GSS}$	± 30		V
Drain Current	@T <sub>c</sub> =25	8	8*	A
	@T <sub>c</sub> =100	5	5*	
	Pulsed (Note1)	$I_{DP}$	18	
Single Pulsed Avalanche Energy (Note 2)	$E_{AS}$	230		mJ
Repetitive Avalanche Energy (Note 1)	$E_{AR}$	14.7		mJ
Peak Diode Recovery dv/dt (Note 3)	dv/dt	4.5		V/ns
Drain Power Dissipation	T <sub>c</sub> =25	160	52	W
	Derate above 25	1.28	0.42	W/°C
Maximum Junction Temperature	T <sub>j</sub>	150		
Storage Temperature Range	T <sub>stg</sub>	-55 150		
<b>Thermal Characteristics</b>				
Thermal Resistance, Junction-to-Case	R <sub>thJC</sub>	0.78	2.4	/W
Thermal Resistance, Junction-to-Ambient	R <sub>thJA</sub>	62.5	62.5	/W

\* : Drain current limited by maximum junction temperature.

### PIN CONNECTION

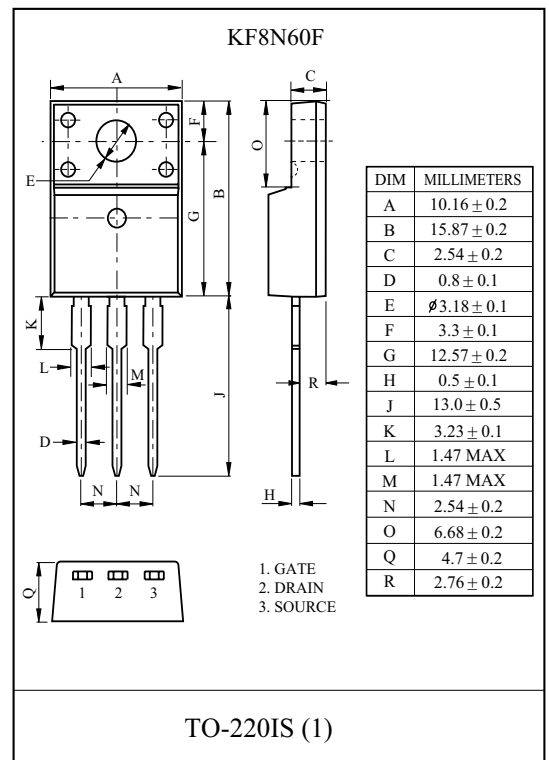
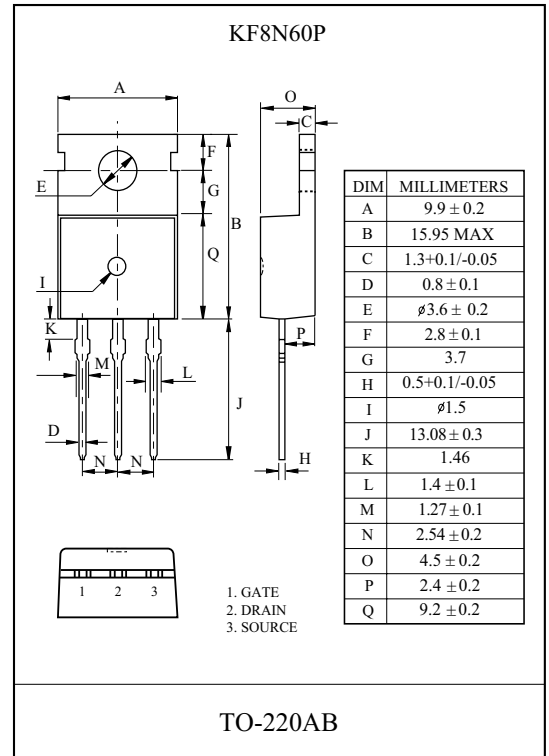
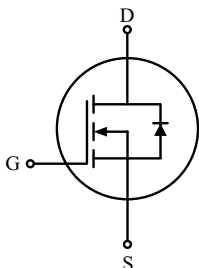

# KF8N60P/F

## ELECTRICAL CHARACTERISTICS (Tc=25 )

CHARACTERISTIC	SYMBOL	TEST CONDITION	MIN.	TYP.	MAX.	UNIT
<b>Static</b>						
Drain-Source Breakdown Voltage	$BV_{DSS}$	$I_D=250\ \mu A, V_{GS}=0V$	600	-	-	V
Breakdown Voltage Temperature Coefficient	$BV_{DSS}/T_j$	$I_D=250\ \mu A$ , Referenced to 25	-	0.65	-	V/
Drain Cut-off Current	$I_{DSS}$	$V_{DS}=600V, V_{GS}=0V$	-	-	10	$\mu A$
Gate Threshold Voltage	$V_{th}$	$V_{DS}=V_{GS}, I_D=250\ \mu A$	2.5	-	4.5	V
Gate Leakage Current	$I_{GSS}$	$V_{GS}=\pm 30V, V_{DS}=0V$	-	-	$\pm 100$	nA
Drain-Source ON Resistance	$R_{DS(ON)}$	$V_{GS}=10V, I_D=4A$	-	0.85	1.05	
<b>Dynamic</b>						
Total Gate Charge	$Q_g$	$V_{DS}=480V, I_D=8A$ $V_{GS}=10V$ (Note4,5)	-	22	-	nC
Gate-Source Charge	$Q_{gs}$		-	5	-	
Gate-Drain Charge	$Q_{gd}$		-	8	-	
Turn-on Delay time	$t_{d(on)}$	$V_{DD}=300V$ $I_D=8A$ $R_G=25$ (Note4,5)	-	45	-	ns
Turn-on Rise time	$t_r$		-	35	-	
Turn-off Delay time	$t_{d(off)}$		-	75	-	
Turn-off Fall time	$t_f$		-	30	-	
Input Capacitance	$C_{iss}$	$V_{DS}=25V, V_{GS}=0V, f=1.0MHz$	-	1000	-	pF
Output Capacitance	$C_{oss}$		-	115	-	
Reverse Transfer Capacitance	$C_{rss}$		-	8	-	
<b>Source-Drain Diode Ratings</b>						
Continuous Source Current	$I_S$	$V_{GS}<V_{th}$	-	-	8	A
Pulsed Source Current	$I_{SP}$		-	-	32	
Diode Forward Voltage	$V_{SD}$	$I_S=8.0A, V_{GS}=0V$	-	-	1.4	V
Reverse Recovery Time	$t_{rr}$	$I_S=8.0A, V_{GS}=0V,$	-	400	-	ns
Reverse Recovery Charge	$Q_{rr}$	$dI_S/dt=100A/\mu s$	-	4.1	-	$\mu C$

Note 1) Repetivity rating : Pulse width limited by junction temperature.

Note 2)  $L=6.7mH, I_S=8A, V_{DD}=50V, R_G=25$  , Starting  $T_j=25$  .

Note 3)  $I_S=8.0A, dI/dt=200A/\mu s, V_{DD}=BV_{DSS}$ , Starting  $T_j=25$  .

Note 4) Pulse Test : Pulse width  $300\mu s$ , Duty Cycle 2%.

Note 5) Essentially independent of operating temperature.

## Marking

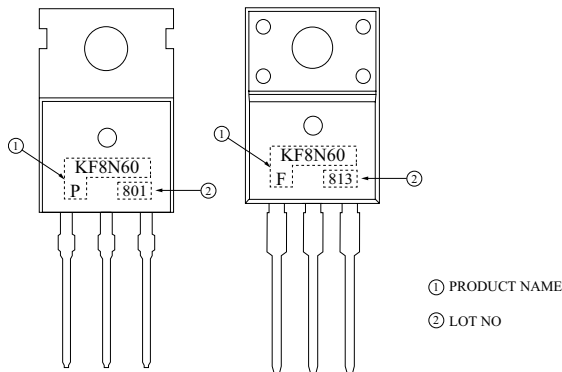

# KF8N60P/F

Fig1.  $I_D - V_{DS}$

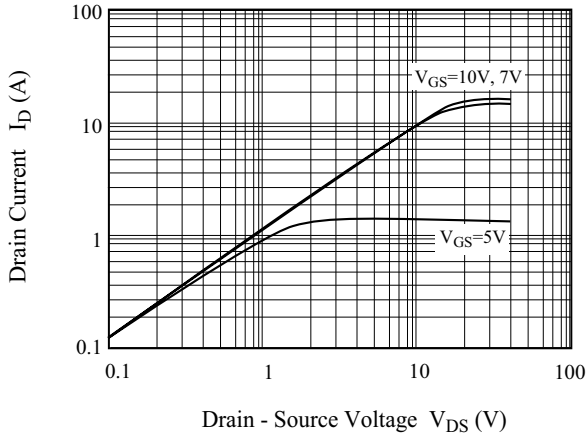

Fig2.  $I_D - V_{GS}$

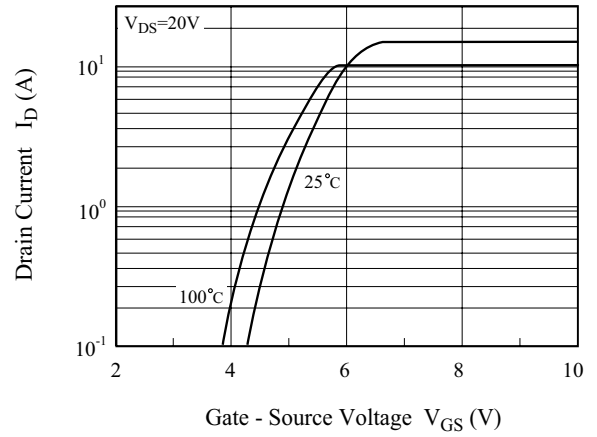

Fig3.  $BV_{DSS} - T_j$

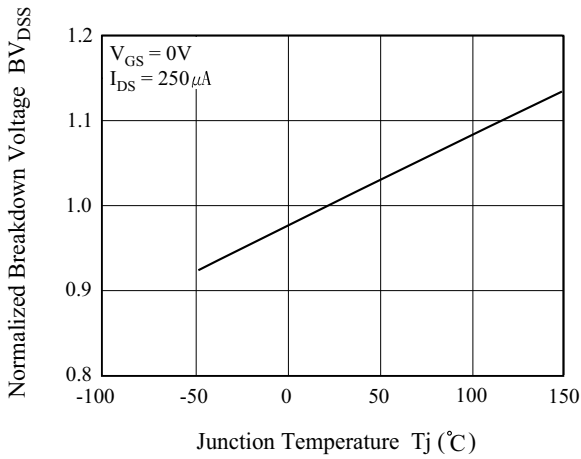

Fig4.  $R_{DS(ON)} - I_D$

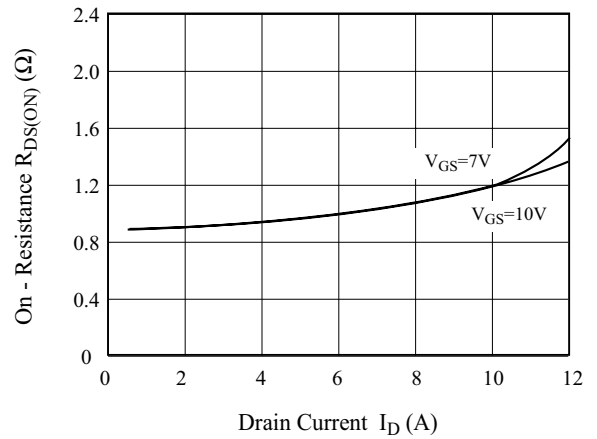

Fig5.  $I_S - V_{SD}$

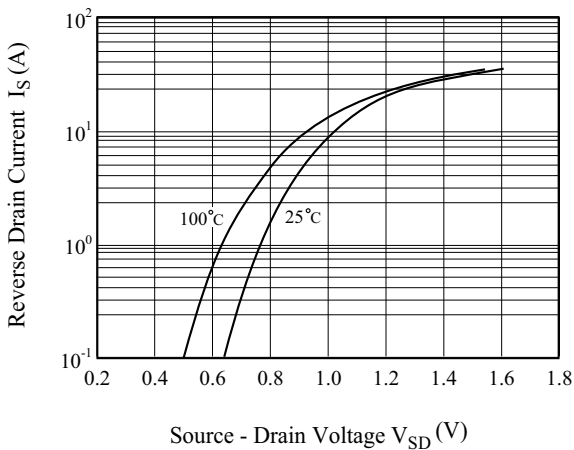
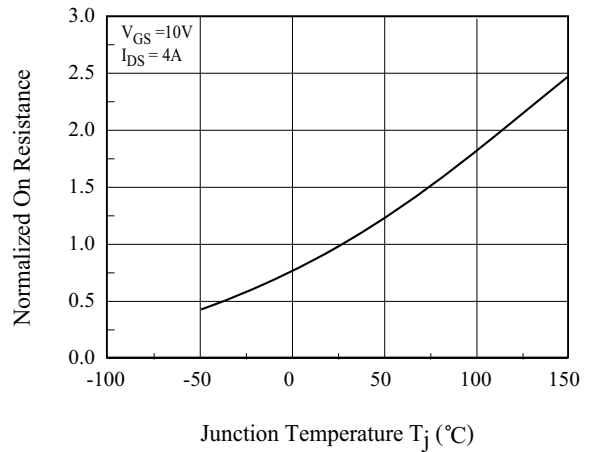

Fig6.  $R_{DS(ON)} - T_j$



# KF8N60P/F

Fig 7. C - V<sub>DS</sub>

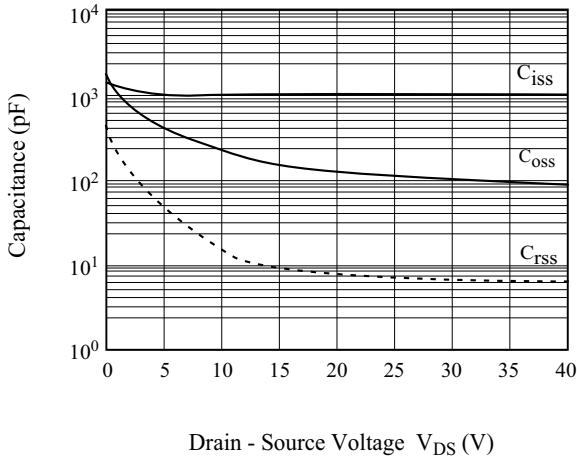

Fig8. Qg- V<sub>GS</sub>

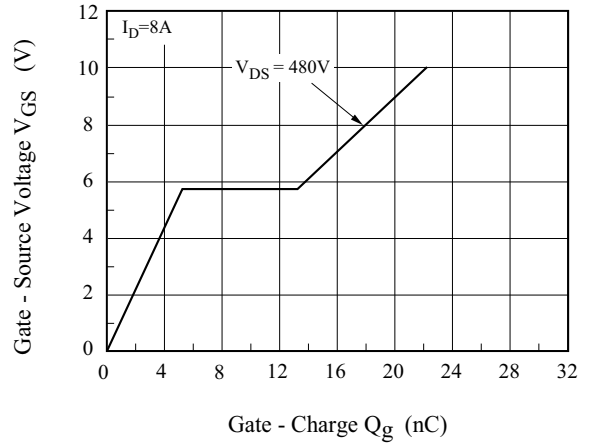

Fig9. Safe Operation Area

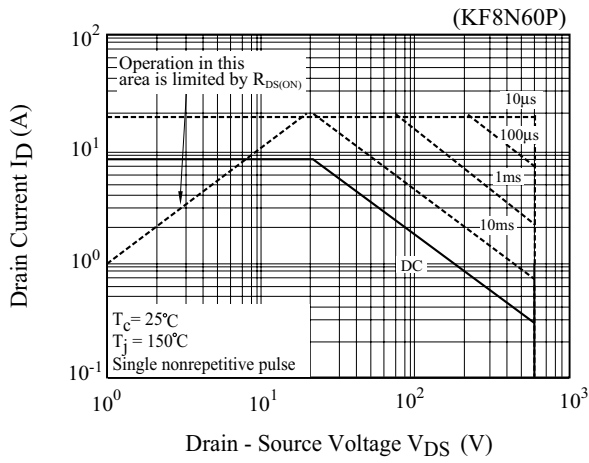

Fig10. Safe Operation Area

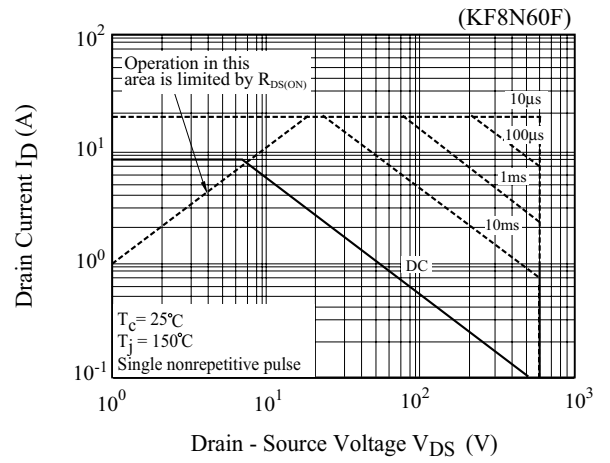
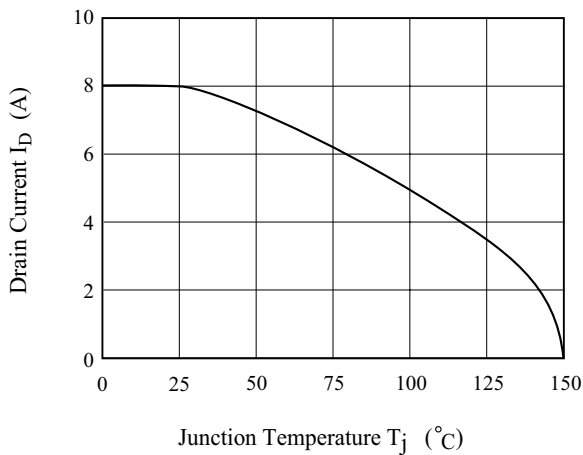

Fig11. ID - Tj



# KF8N60P/F

Fig12. Transient Thermal Response Curve

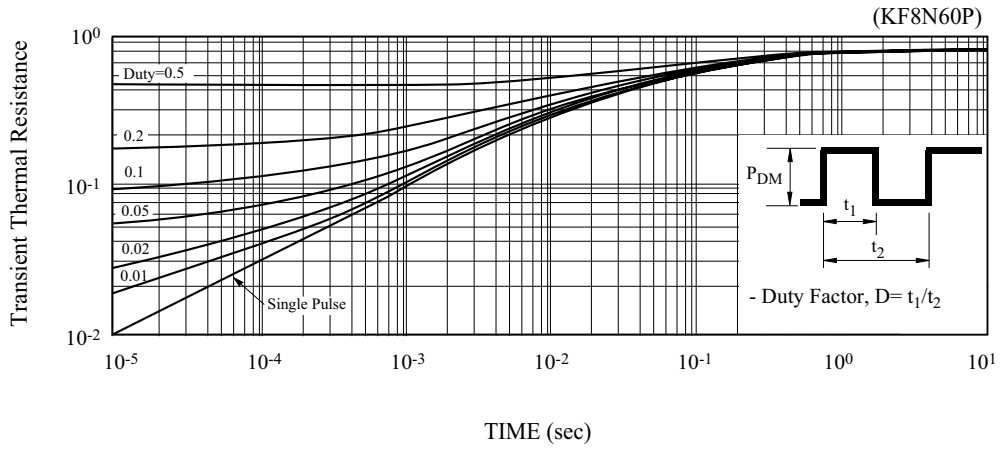
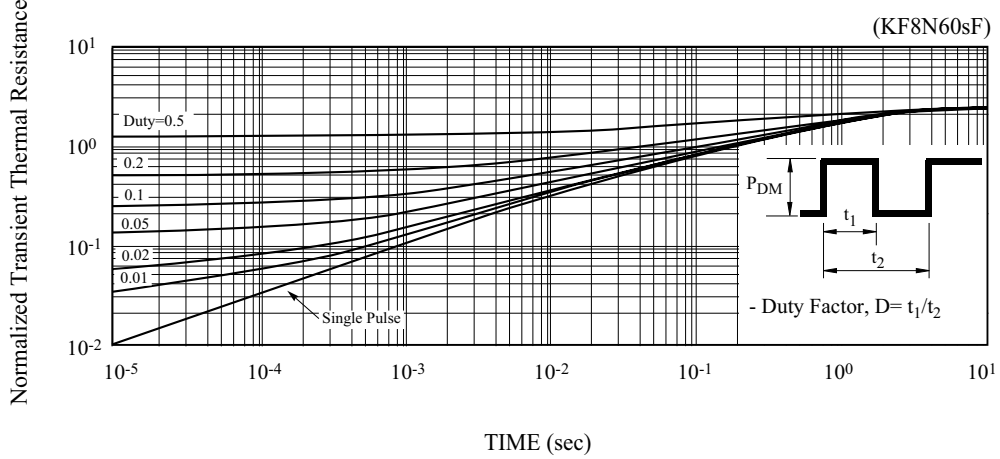

Fig13. Transient Thermal Response Curve



# KF8N60P/F

Fig14. Gate Charge

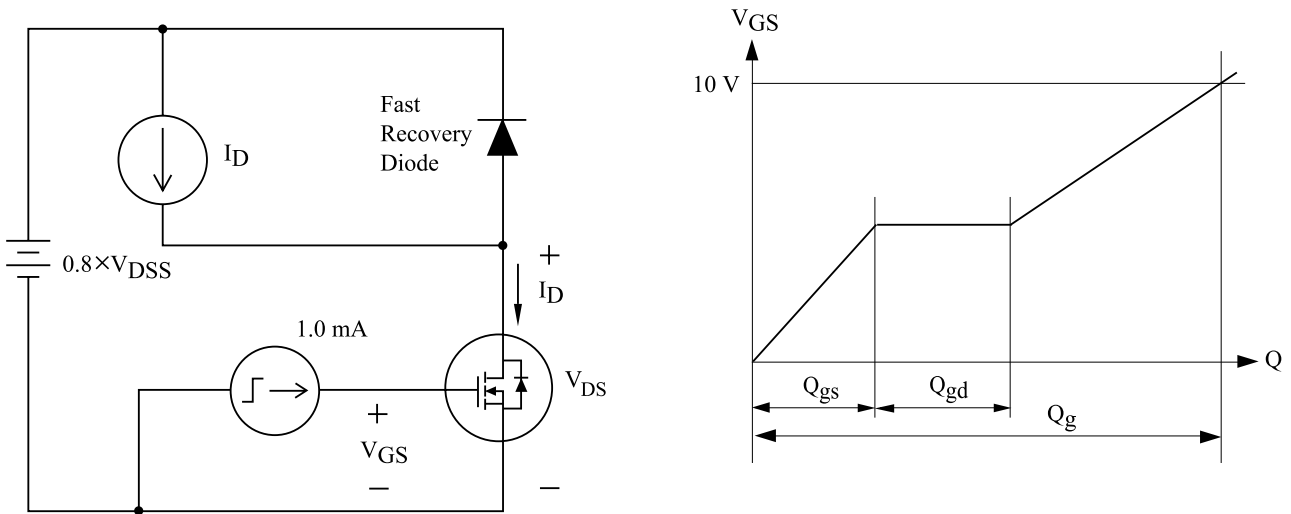

Fig15. Single Pulsed Avalanche Energy

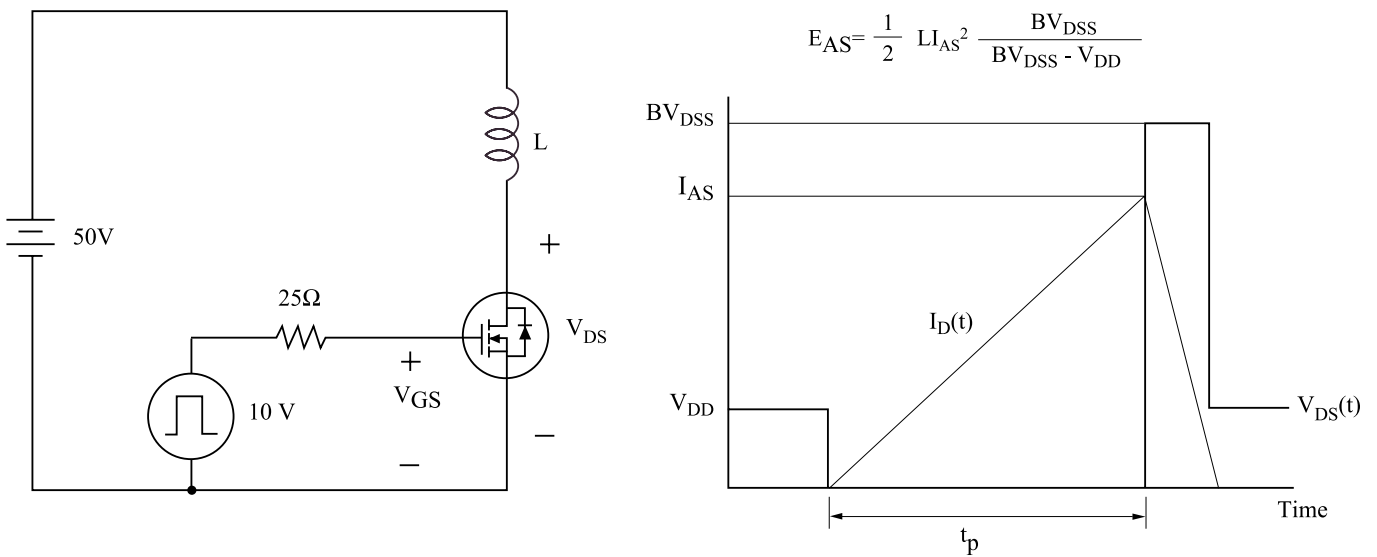
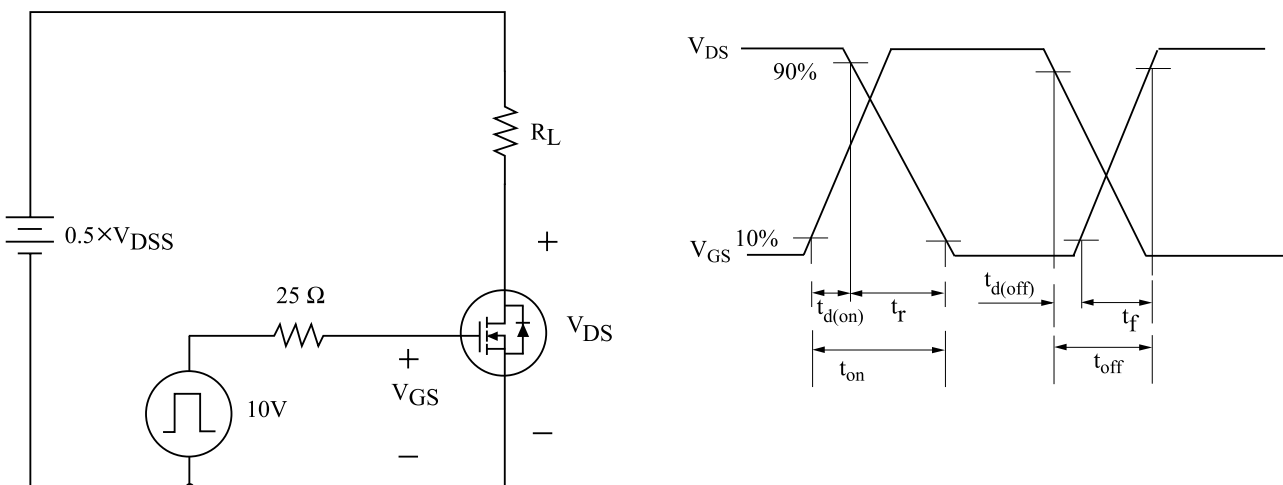

Fig16. Resistive Load Switching



# KF8N60P/F

Fig17. Source - Drain Diode Reverse Recovery and  $dv/dt$

