

LOW DROP FIXED AND ADJUSTABLE POSITIVE VOLTAGE REGULATOR

The KIA1117BS/BF/BPI × × Series are a Low Drop Voltage Regulator able to provide up to 1A of output current, available even in adjustable version (Vref=1.25V)

FEATURES

- Low Dropout Voltage : 1.1V/Typ. (Iout=1.0A)
- Very Low Quiescent Current : 5mA(Typ)
- Output Current up to 1A
- Fixed Output Voltage of 1.2V, 1.5V, 1.8V, 2.5V, 3.3V, 5.0V
- Adjustable Version Availability : Vref=1.25V
- Internal Current and Thermal Limit
- A Minimum of 10μF for stability
- Suitable for MLCC, Tantalum and Low ESR Electrolytic Capacitors
- ESR Range for stability : 1m ~200
- Available in ± 2%(at 25)
- High Ripple Rejection : 80dB(Typ)
- Temperature Range : -40 150

LINE UP

ITEM	OUTPUT VOLTAGE (V)	PACKAGE
KIA1117BS/BF/BPI00	Adjustable (1.25~10V)	BS : SOT-223 BF : DPAK BPI : TO-220IS
KIA1117BS/BF/BPI12	1.2	
KIA1117BS/BF/BPI15	1.5	
KIA1117BS/BF/BPI18	1.8	
KIA1117BS/BF/BPI25	2.5	
KIA1117BS/BF/BPI33	3.3	
KIA1117BS/BF/BPI50	5.0	

MAXIMUM RATINGS (Ta=25)

CHARACTERISTIC	SYMBOL	RATING	UNIT
Input Voltage	V _{IN}	15	V
Output Current	I _{OUT}	1.0	A
Power Dissipation 1 (No Heatsink)	S (Note)	1.0	W
	F	1.3	
	PI	2.0	
Power Dissipation 2 (Infinite Heatsink)	S	8.3	W
	F	13	
	PI	20.8	
Maximum Junction Temperature	T _{j(max)}	150	
Operating Junction Temperature	T _{opr}	-40 150	
Storage Temperature	T _{stg}	-55 150	

Note) Package Mounted on FR-4 PCB 36mm × 18mm × 1.5mm.
: mounting pad for the GND Lead min. 6cm²

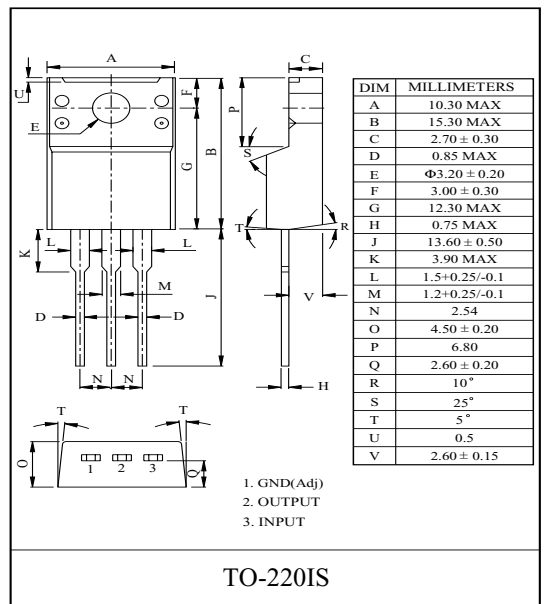
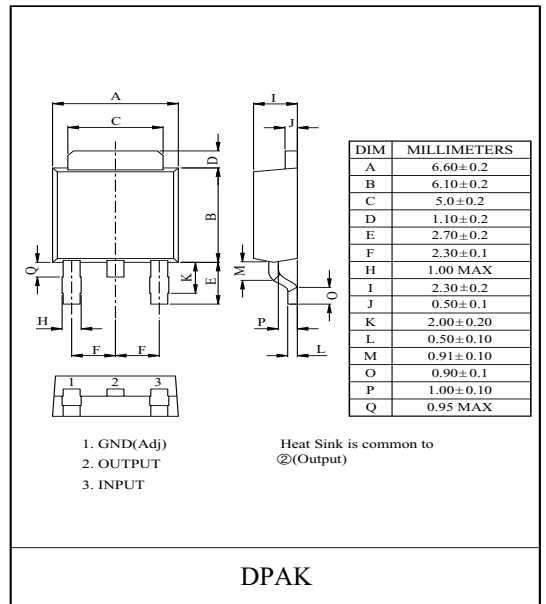
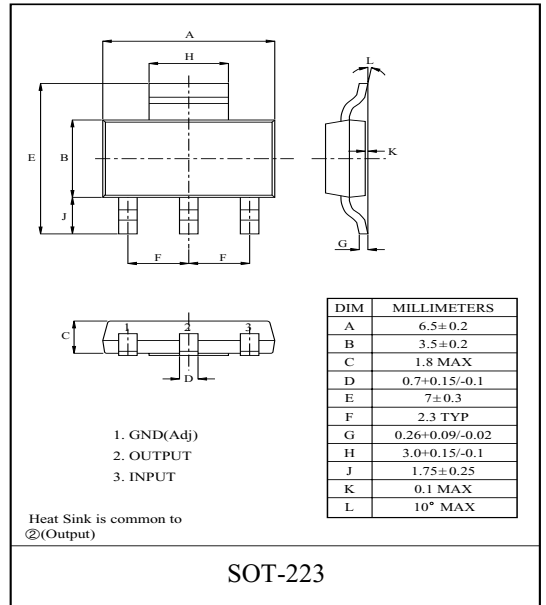

KIA1117BS/BF/BPI00 ~ KIA1117BS/BF/BPI50

ELECTRICAL CHARACTERISTICS

Unless otherwise specified, $T_j=25$

CHARACTERISTIC	ITEM	SYMBOL	TEST CONDITIONS	MIN.	TYP.	MAX.	UNIT	
Reference Voltage	KIA1117-Adj	V_{REF1}	$V_{IN}=V_{OUT}+1.5V, I_{OUT}=10mA$	1.225	1.25	1.275	V	
		V_{REF2}	$10mA, I_{OUT} 1A, V_{OUT}+1.5V, V_{IN}=10V$	1.213	1.25	1.288	V	
Output Voltage	KIA1117-12	V_{OUT1}	$V_{IN}=2.7V, I_{OUT}=10mA$	1.176	1.2	1.224	V	
		V_{OUT2}	$10mA, I_{OUT} 1A, 2.7V, V_{IN} 10V$	1.164	1.2	1.236	V	
	KIA1117-15	V_{OUT1}	$V_{IN}=3.0V, I_{OUT}=10mA$	1.470	1.5	1.530	V	
		V_{OUT2}	$10mA, I_{OUT} 1A, 3.0V, V_{IN} 10V$	1.460	1.5	1.540	V	
	KIA1117-18	V_{OUT1}	$V_{IN}=3.3V, I_{OUT}=10mA$	1.764	1.8	1.836	V	
		V_{OUT2}	$10mA, I_{OUT} 1A, 3.3V, V_{IN} 10V$	1.754	1.8	1.846	V	
	KIA1117-25	V_{OUT1}	$V_{IN}=4.0V, I_{OUT}=10mA$	2.450	2.5	2.550	V	
		V_{OUT2}	$10mA, I_{OUT} 1A, 4.0V, V_{IN} 10V$	2.440	2.5	2.560	V	
	KIA1117-33	V_{OUT1}	$V_{IN}=4.8V, I_{OUT}=10mA$	3.234	3.3	3.366	V	
		V_{OUT2}	$10mA, I_{OUT} 1A, 4.8V, V_{IN} 10V$	3.201	3.3	3.399	V	
	KIA1117-50	V_{OUT1}	$V_{IN}=6.5V, I_{OUT}=10mA$	4.900	5.0	5.100	V	
		V_{OUT2}	$10mA, I_{OUT} 1A, 6.5V, V_{IN} 10V$	4.850	5.0	5.150	V	
	Line Regulation	-	Reg Line	$V_{OUT}+1.5V, V_{IN} 10V, I_{OUT}=10mA$	-	1	10	mV
	Load Regulation	-	Reg Load	$10mA, I_{OUT} 1A, V_{IN}=V_{OUT}+2.0V$	-	0.5	1	%
	Adjustable Pin Current	KIA1117-Adj	I_{ADJ}	$V_{IN}=V_{OUT}+1.5V$	-	35	-	μA
	Minimum Load Current	KIA1117-Adj	I_{MIN}	$V_{IN}=V_{OUT}+1.5V$	10	-	-	mA
Quiescent Current	-	I_{B1}	$V_{IN}=V_{OUT}+1.25V, I_{OUT}=0A$	-	5	10	mA	
		I_{B2}	$V_{IN}=10V, I_{OUT}=0A$	-	5	10		
Output Noise Voltage	-	V_{NO}	$V_{IN}=V_{OUT}+1.25V, I_{OUT}=40mA,$ $10Hz \leq f \leq 10kHz$	-	100	-	μV_{rms}	
Short Circuit Current Limit	-	I_{SC}	$V_{IN}=V_{OUT}+2.0V$	1.1	-	-	A	
Ripple Rejection	-	$R \cdot R$	$I_{OUT}=40mA, f=120Hz, V_{ripple}=1V_{p-p}$ $V_{IN}=V_{OUT}+3V$	60	80	-	dB	
Dropout Voltage	-	V_D	$I_{OUT}=1A$	-	1.1	1.4	V	
Temperature Stability	-	TCV_O	$V_{IN}=V_{OUT}+1.5V, I_{OUT}=10mA, T_j=-40\sim 150$	-	0.5	-	%	

KIA1117BS/BF/BPI00 ~ KIA1117BS/BF/BPI50

Fig.1 Application Circuit-1 (Fixed-Type)

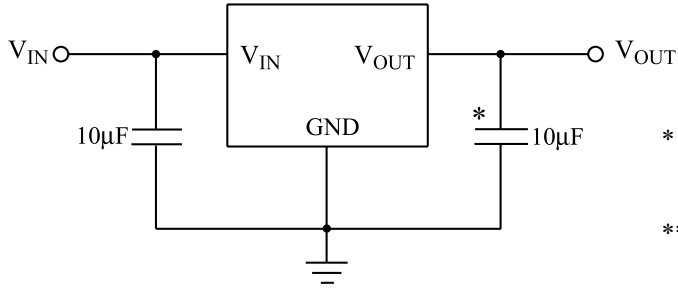

* Note 1) MLCC, Tantalum, Low ESR Electrolytic Capacitors are suitable in ESR range for stability (1m~200)

** Note 2) When R1 is much larger than 124 , apply 8~10mA to Vout-GND by setting an additional dummy resistor for stability of Vout under no load condition

Fig.2 Application Circuit-2 (Adjustable-Type)

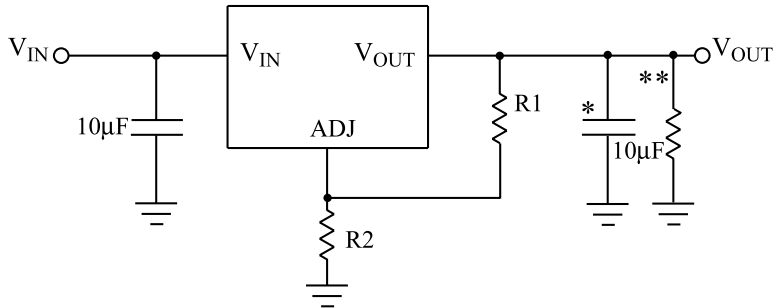

$$V_{OUT} = V_{REF} \times (1 + R2/R1) + I_{ADJ} \times R2$$

KIA1117BS/BF/BPI00 ~ KIA1117BS/BF/BPI50

Fig. 3 $V_D - I_{OUT}$

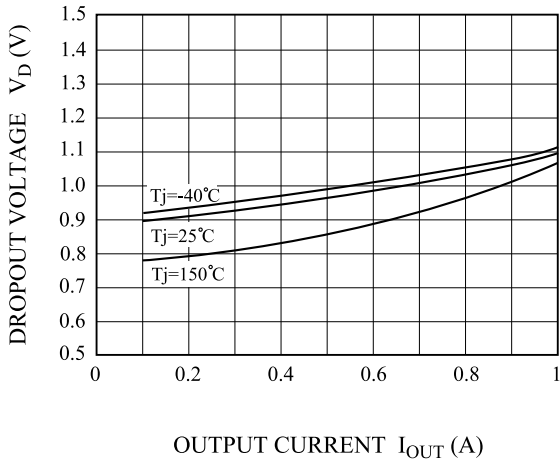

Fig. 4 $V_{OUT}(\text{CHANGE}) - T_j$

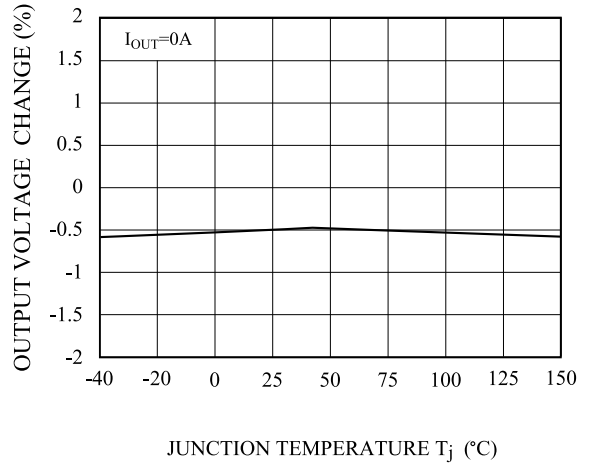

Fig. 5 LINE REGULATION

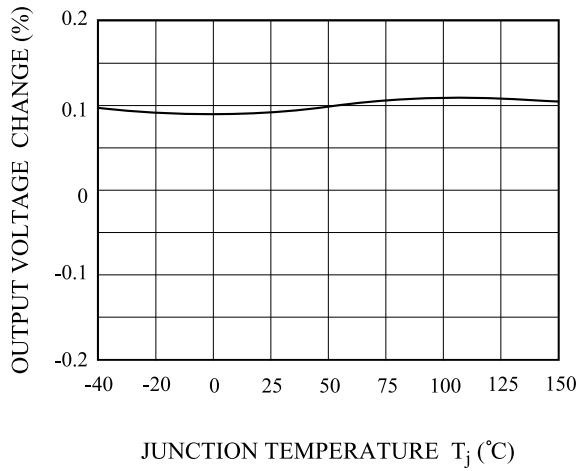

Fig. 6 LOAD REGULATION

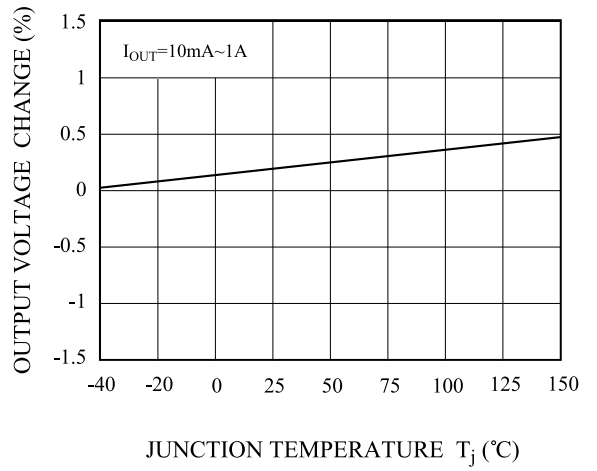

Fig.7 $I_Q - T_j$

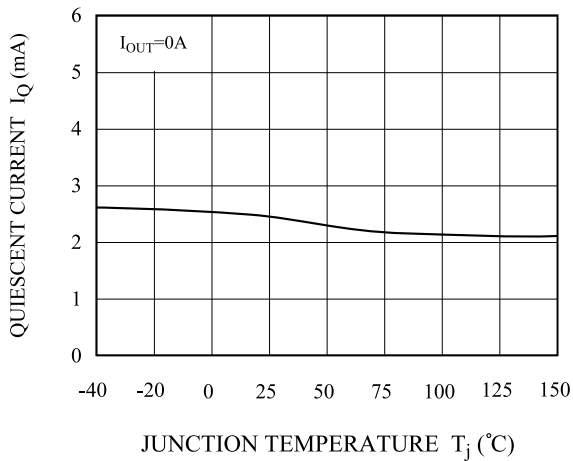
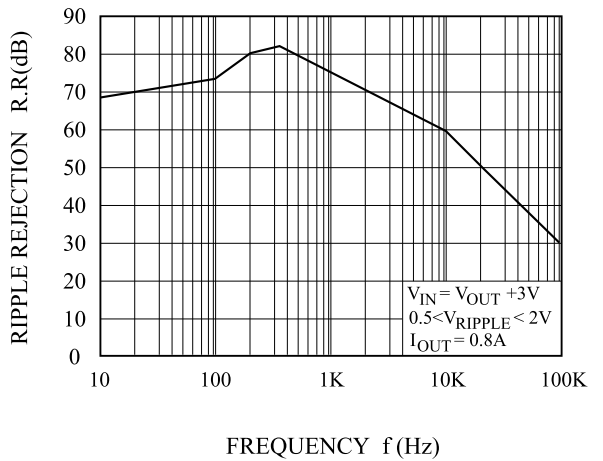

Fig.8 R.R - f



KIA1117BS/BF/BPI00 ~ KIA1117BS/BF/BPI50

Fig.9 $P_D - T_a$ (S-Type : SOT-223)

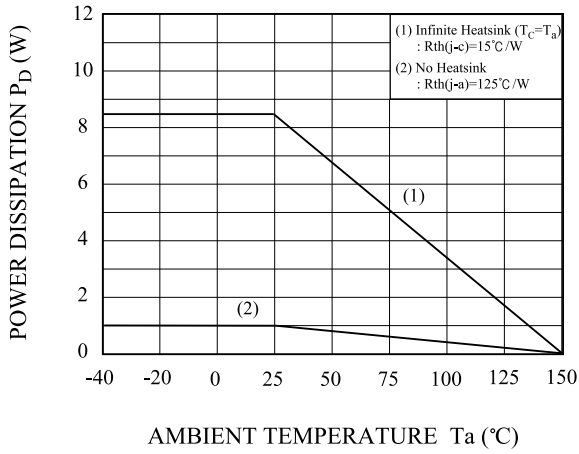

Fig.10 $P_D - T_a$ (F-Type : DPAK)

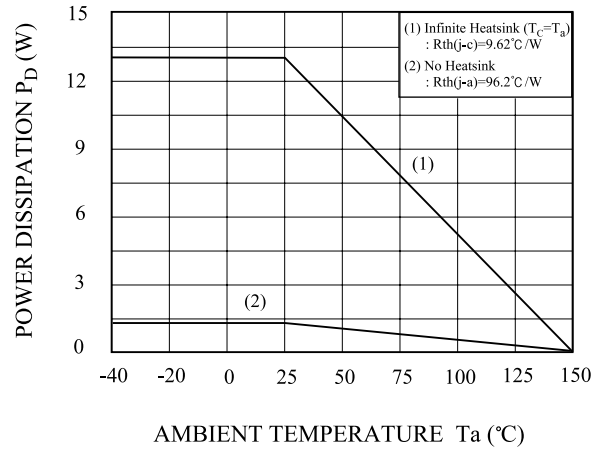

Fig. 11 $P_D - T_a$ (API-Type : TO-220IS)

