

### 3 TERMINAL LOW DROP OUTPUT VOLTAGE REGULATOR

The KIA78D × × Series are fixed positive output low dropout type, 3-pin voltage regulators with positive output. These regulators are used to provide a stabilized output voltage from a fluctuating DC input voltage. These are 12 fixed output voltage, as follows ; 2.5V, 3.3V, 3.5V, 5V, 6V, 8V, 9V, 10V, 12V, and 15V. The maximum current capacity is 1A for each of the above voltage.

#### FEATURES

- Built in over voltage protection circuit, over current protection circuit and thermal shut down circuit.
- Richly diverse Lineup.
- Low minimum I/O voltage differential.

#### LINE UP

ITEM	OUTPUT VOLTAGE (Typ.)	UNIT	PACKAGE
KIA78D25F/PI	2.5	V	F : DPAK PI : TO-220IS
KIA78D33F/PI	3.3		
KIA78D35F/PI	3.5		
KIA78D05F/PI	5		
KIA78D06F/PI	6		
KIA78D08F/PI	8		
KIA78D09F/PI	9		
KIA78D10F/PI	10		
KIA78D12F/PI	12		
KIA78D15F/PI	15		

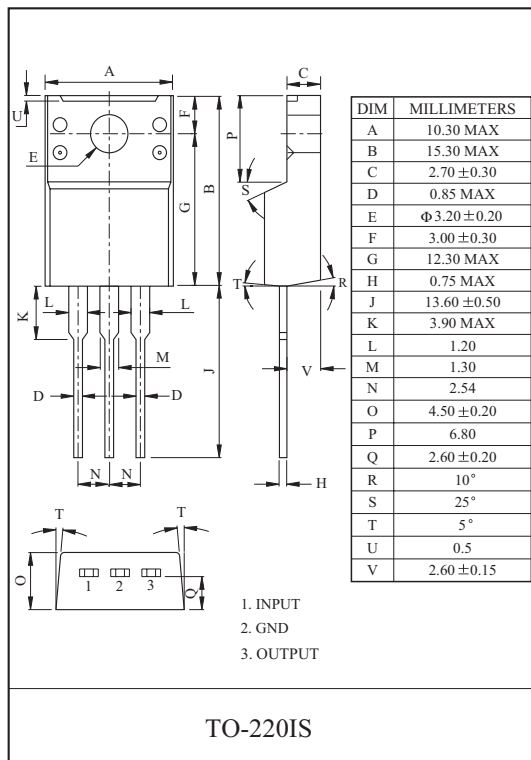
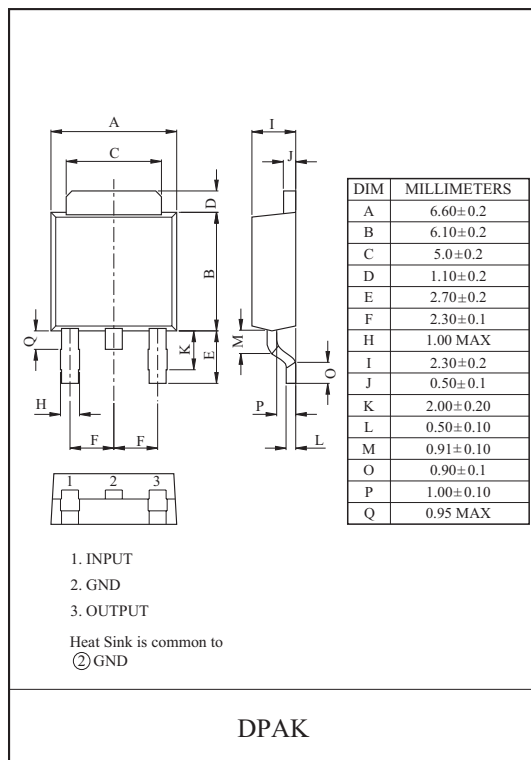

# KIA78D25F/PI~78D15F/PI

## MAXIMUM RATINGS (Ta=25°C)

CHARACTERISTIC		SYMBOL	RATING	UNIT
Input Voltage		$V_{IN}$	35	V
Output Current		$I_O$	1	A
Power Dissipation-1 (No Heatsink)	F	$P_{D1}$	1.3	W
	PI		2.0	
Power Dissipation-2 (Infinite Heatsink)	F	$P_{D2}$	13	
	PI		20.8	
Junction Temperature		$T_j$	150	°C
Operating Temperature		$T_{opr}$	-40 ~ 85	°C
Storage Temperature		$T_{stg}$	-50 ~ 150	°C
Soldering Temperature (10sec)		$T_{sol}$	260	°C

## BLOCK DIAGRAM

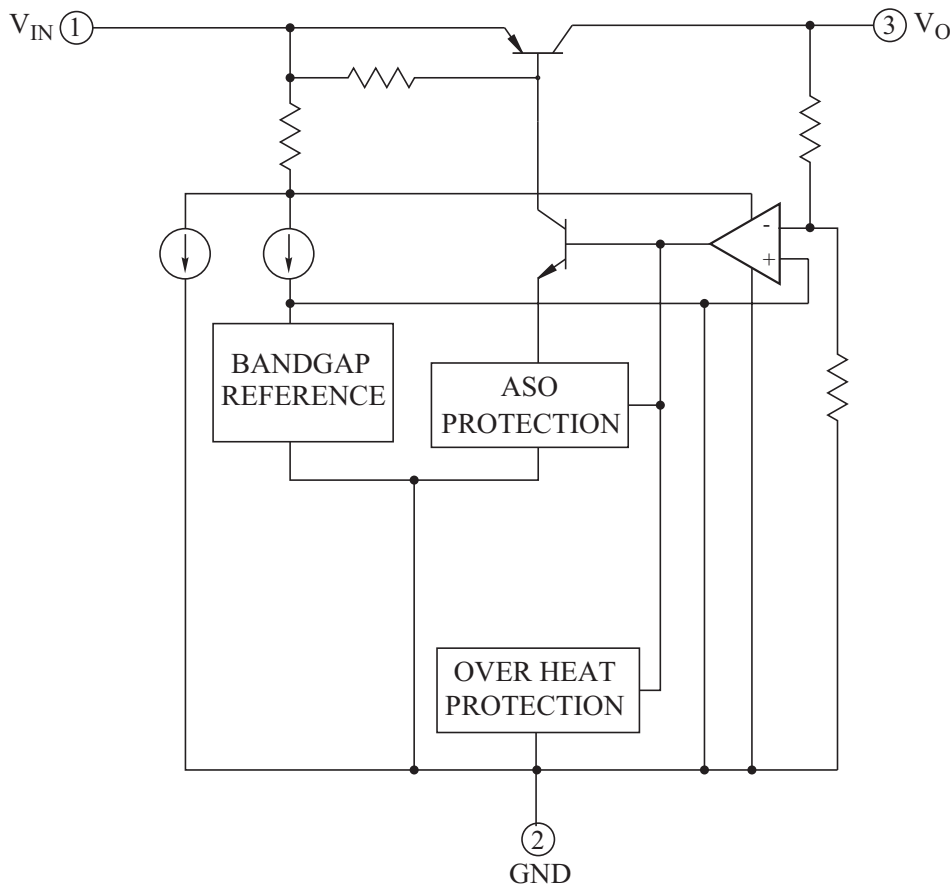

# KIA78D25F/PI~78D15F/PI

## ELECTRICAL CHARACTERISTICS (Unless otherwise specified, $I_0=0.5A$ , $T_a=25^\circ C$ , Note1.)

CHARACTERISTIC		SYMBOL	CONDITIONS	MIN.	TYP.	MAX.	UNIT
Output Voltage	KIA78D25	$V_O$	-	2.438	2.50	2.562	V
	KIA78D33		-	3.220	3.30	3.380	
	KIA78D35		-	3.413	3.50	3.587	
	KIA78D05		-	4.88	5.0	5.12	
	KIA78D06		-	5.85	6.0	6.15	
	KIA78D08		-	7.80	8.0	8.2	
	KIA78D09		-	8.78	9.0	9.22	
	KIA78D10		-	9.75	10.0	10.25	
	KIA78D12		-	11.70	12.0	12.30	
	KIA78D15		-	14.70	15.0	15.30	
Load Regulation		Reg Load	$5mA \leq I_{OUT} \leq 1A$	-	0.1	2.0	%
Line Regulation		Reg Line	(Note 2)	-	0.5	2.5	%
Ripple Rejection		R · R	-	45	55	-	dB
Dropout Voltage		$V_D$	$V_{IN}=0.95V_{OUT}, I_0=1A$	-	-	0.5	V
Quiescent Current		$I_Q$	$I_{OUT}=0A$	-	-	10	mA

Note1)  $V_{IN}$  of KIA78D25=4.2V,  $V_{IN}$  of KIA78D33=5.0V,  $V_{IN}$  of KIA78D35=5.2V,  $V_{IN}$  of KIA78D05=7V,  
 $V_{IN}$  of KIA78D06=8V,  $V_{IN}$  of KIA78D08=10V,  $V_{IN}$  of KIA78D09=15V,  $V_{IN}$  of KIA78D10=16V,  
 $V_{IN}$  of KIA78D12=18V  $V_{IN}$  of KIA78D15=21V

Note2)  $V_{IN}$  of KIA78D25=3.2~10V,  $V_{IN}$  of KIA78D33=4.0~10V,  $V_{IN}$  of KIA78D35=4.2~10V,  
 $V_{IN}$  of KIA78D05=6~12V,  $V_{IN}$  of KIA78D06=7~15V,  $V_{IN}$  of KIA78D08=9~25V,  
 $V_{IN}$  of KIA78D09=10~25V  $V_{IN}$  of KIA78D10=11~26V,  $V_{IN}$  of KIA78D12=13~29V  $V_{IN}$  of KIA78D15=16~32V

# KIA78D25F/PI~78D15F/PI

Fig. 1 Standard Test Circuit

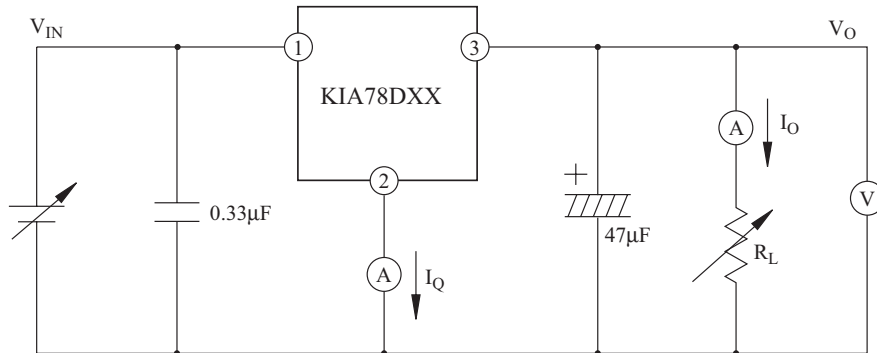

Fig. 2 Ripple Rejection Test Circuit

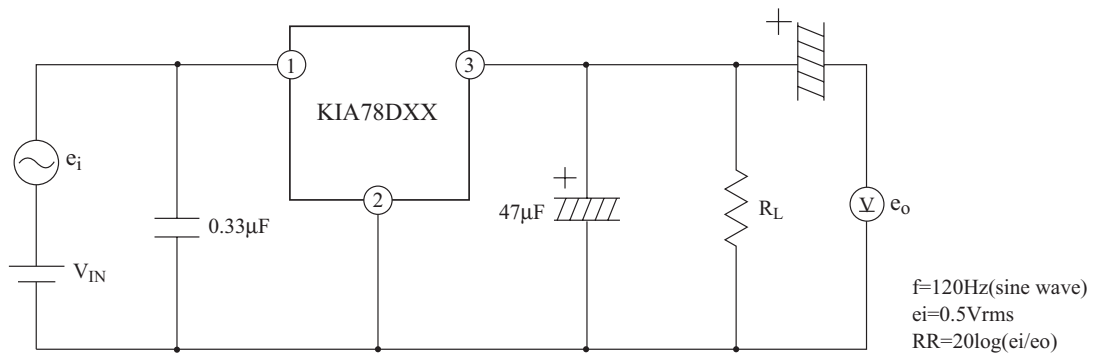
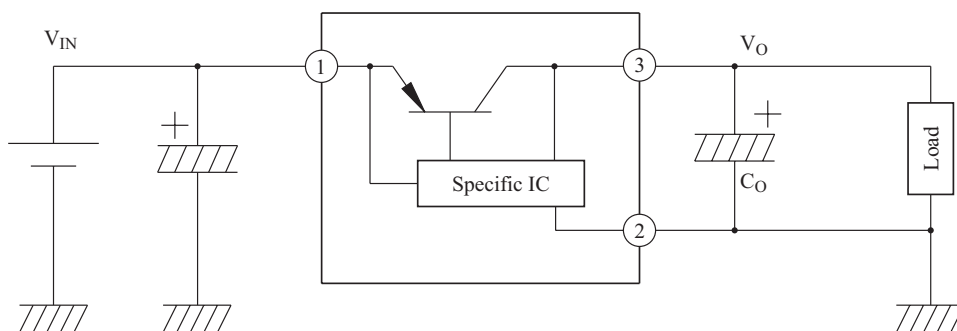

Fig. 3 Application Circuit for Standard



# KIA78D25F/PI~78D15F/PI

Fig.4  $P_D - T_a$  (F-Type : DPAK)

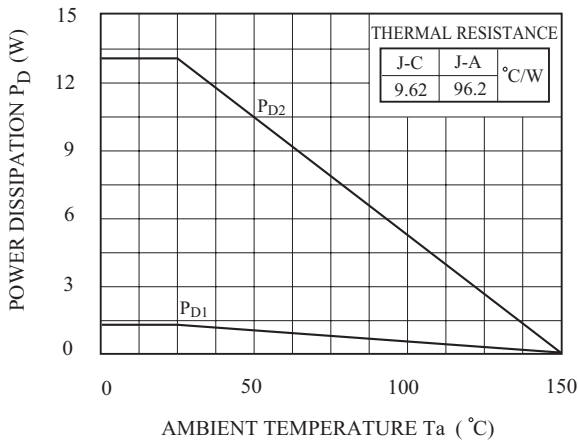

Fig.5  $P_D - T_a$  (PI-Type : TO-220IS)

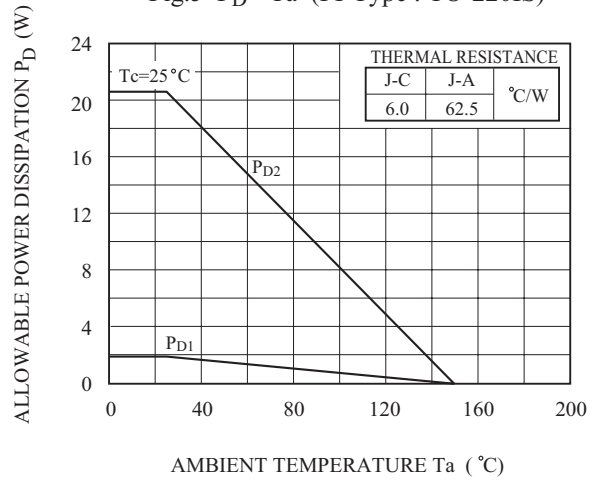

Fig.6  $T_j - \Delta V_o$  (KIA78D25)

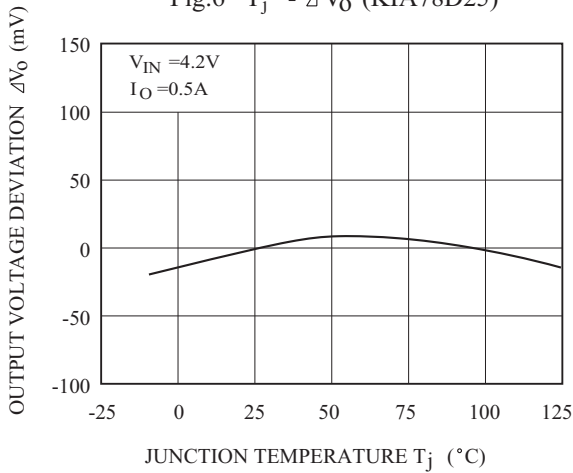

Fig.7  $T_j - \Delta V_o$  (KIA78D33)

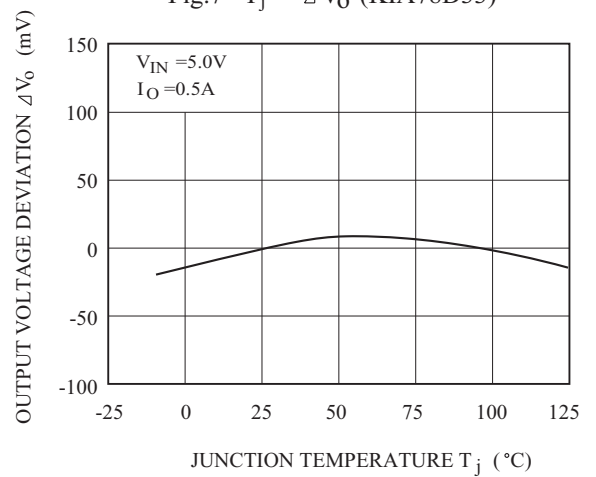

Fig.8  $T_j - \Delta V_o$  (KIA78D25)

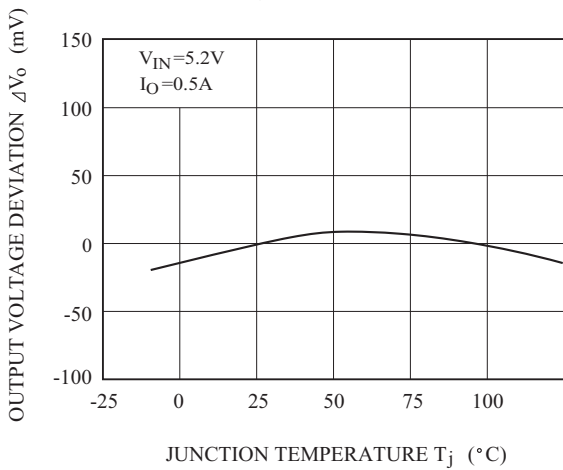
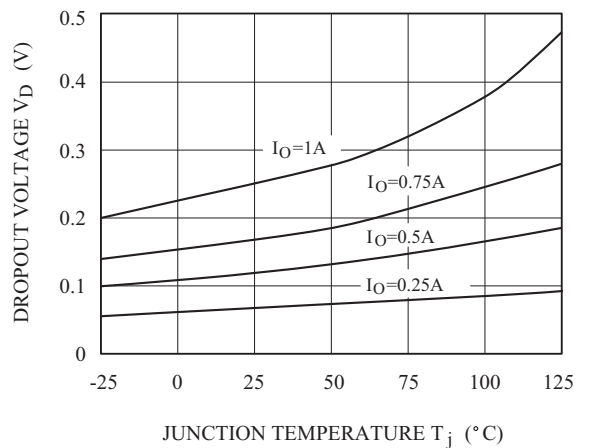

Fig.9  $T_j - V_D$



# KIA78D25F/PI~78D15F/PI

Fig.10  $T_j - I_q$

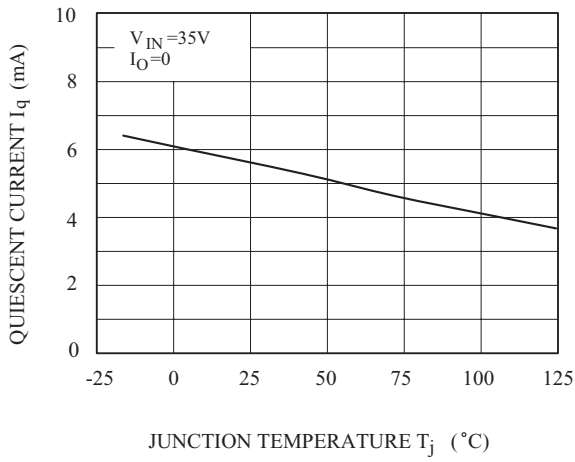

Fig.11  $f - R \cdot R$

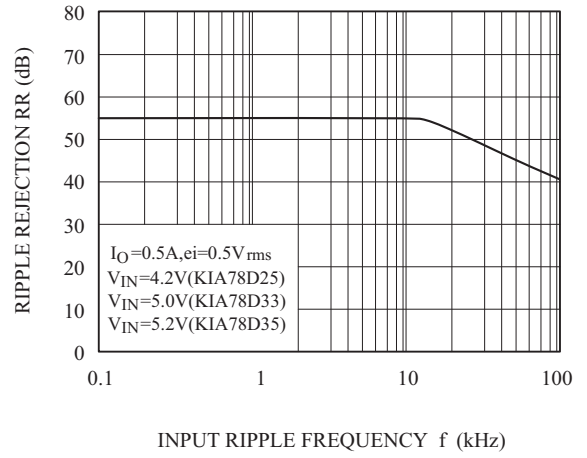

Fig.12  $I_O - R \cdot R$

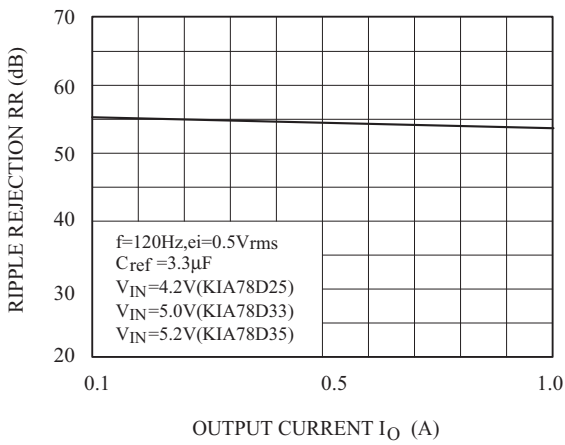

Fig. 13  $I_O - V_O$

