

General Description

It is mainly suitable for battery pack or power management in cell phone, and PDA.

FEATURES

- $V_{DSS} = -20V$, $I_D = -10A$.
- Drain-Source ON Resistance.
 - : $R_{DS(ON)} = 14m\ \Omega$ (Max.) @ $V_{GS} = -4.5V$, $I_D = -10A$.
 - : $R_{DS(ON)} = 24m\ \Omega$ (Max.) @ $V_{GS} = -2.5V$, $I_D = -7.6A$.

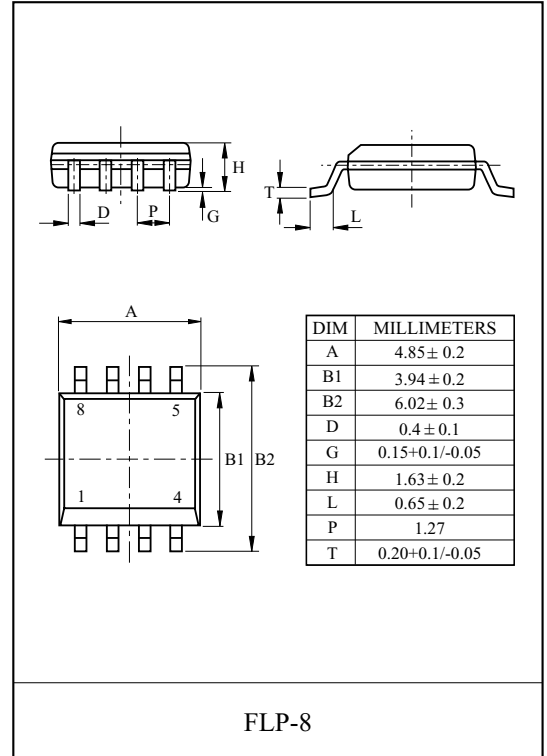

MAXIMUM RATING (Ta=25 °C)

CHARACTERISTIC		SYMBOL	RATING	UNIT
Drain-Source Voltage		V_{DSS}	-20	V
Gate-Source Voltage		V_{GSS}	±12	V
Drain Current	DC	I_D^*	±10	A
	Pulsed (Note1)	I_{DP}^*	±48	
Source-Drain Diode Current		I_S^*	-2.3	A
Drain Power Dissipation	Ta=25 °C	P_D^*	1.6	W
	Ta=100 °C		0.625	
Maximum Junction Temperature		T_j	150	°C
Storage Temperature Range		T_{stg}	-55 ~ 150	°C
Thermal Resistance, Junction to Ambient		R_{thJA}^*	80	°C/W

* : Surface Mounted on 1" × 1" FR4 Board, t ≤ 5sec.

PIN CONNECTION (TOP VIEW)

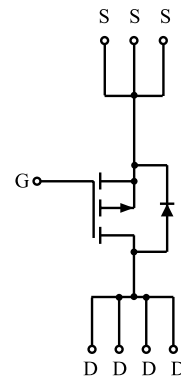
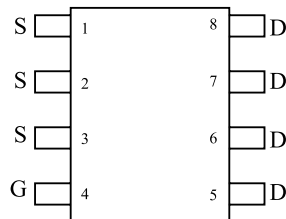

KMA010P20Q

ELECTRICAL CHARACTERISTICS (Ta=25 °C)

CHARACTERISTIC	SYMBOL	TEST CONDITION	MIN.	TYP.	MAX.	UNIT
Static						
Drain-Source Breakdown Voltage	BV_{DSS}	$I_D=-250\mu A, V_{GS}=0V,$	-20	-	-	V
Drain Cut-off Current	I_{DSS}	$V_{GS}=0V, V_{DS}=-20V$	-	-	-1	μA
		$V_{GS}=0V, V_{DS}=-16V, T_j=70\text{ }^\circ C$	-	-	-5	
Gate Threshold Voltage	V_{th}	$V_{DS}=V_{GS}, I_D=-250\mu A$	-0.6	-	-	V
Gate Leakage Current	I_{GSS}	$V_{GS}=\pm 12V, V_{DS}=0V$	-	-	± 100	nA
Drain-Source ON Resistance	$R_{DS(ON)}$	$V_{GS}=-4.5V, I_D=-10A$ (Note 1)	-	11	14	m Ω
		$V_{GS}=-2.5V, I_D=-7.6A$ (Note 1)	-	18	24	
ON State Drain Current	$I_{D(ON)}$	$V_{GS}=-4.5V, V_{DS}=-5V$ (Note 1)	-48	-	-	A
Forward Transconductance	g_{fs}	$V_{DS}=-5V, I_D=-10A$ (Note 1)	-	31	-	S
Source-Drain Diode Forward Voltage	V_{SD}	$I_S=-10A, V_{GS}=0V$ (Note 1)	-	-	-1.1	V
Dynamic (Note 2)						
Total Gate Charge	Q_g	$V_{DS}=-10V, R_D=1.0\ \Omega$ $V_{GS}=-4.5V$ (Fig.1)	-	36	-	nC
Gate-Source Charge	Q_{gs}		-	5	-	
Gate-Drain Charge	Q_{gd}		-	13	-	
Turn-on Delay time	$t_{d(on)}$	$V_{DD}=-10V, R_D=1.0\ \Omega,$ $V_{GS}=-4.5V, R_G=6\ \Omega$ (Fig.2)	-	10	-	ns
Turn-on Rise time	t_r		-	72	-	
Turn-off Delay time	$t_{d(off)}$		-	78	-	
Turn-off Fall time	t_f		-	108	-	

Note 1) Pulse test : Pulse width $\leq 300\ \mu s$, Duty Cycle $\leq 2\%$.

Note 2) Guaranteed by design. Not subject to production testing.

KMA010P20Q

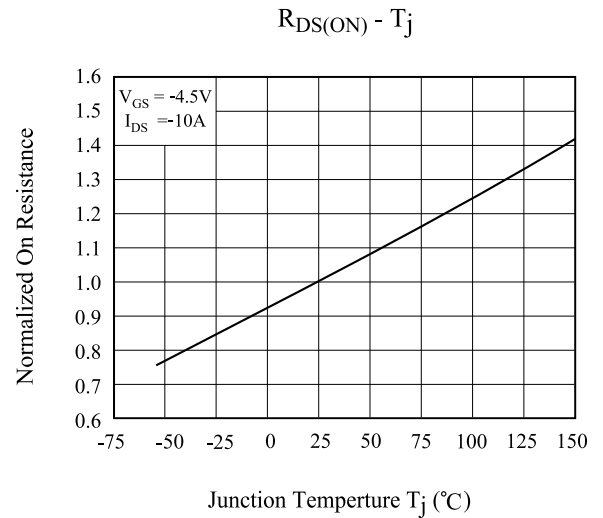
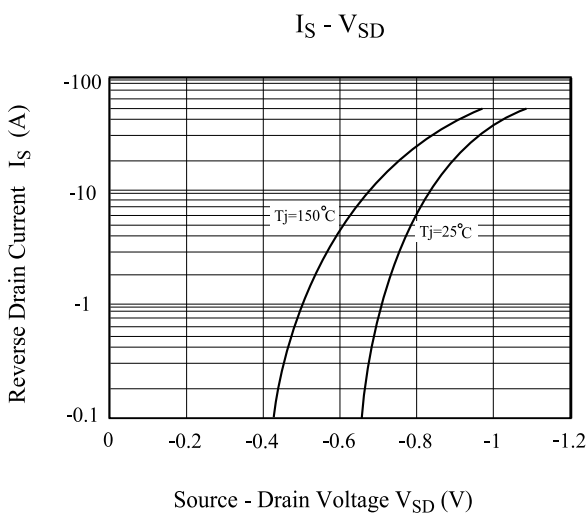
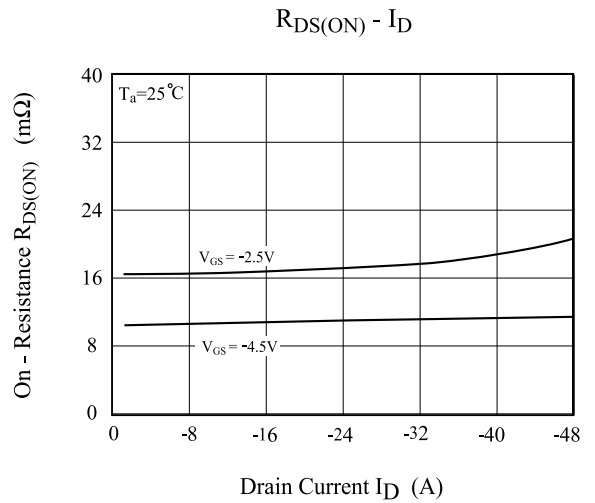
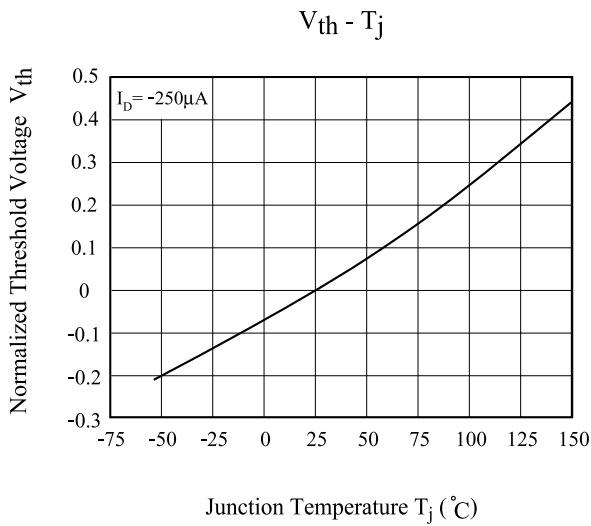
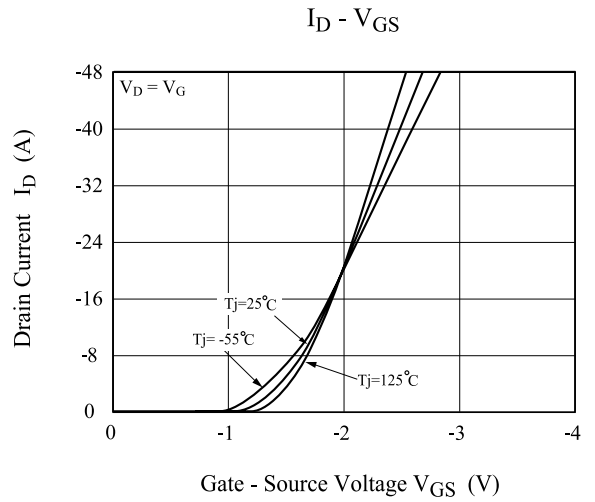
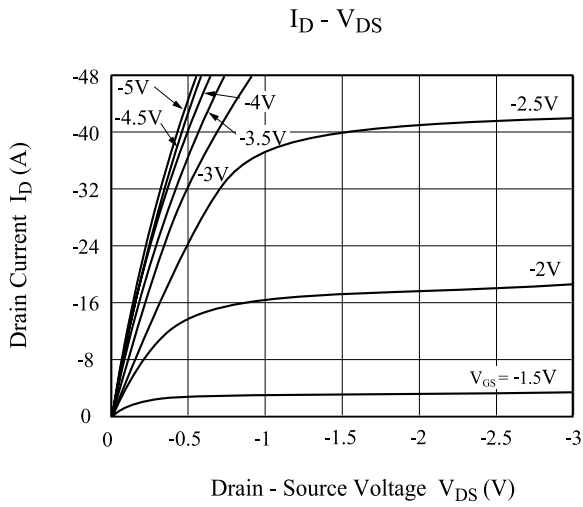

KMA010P20Q

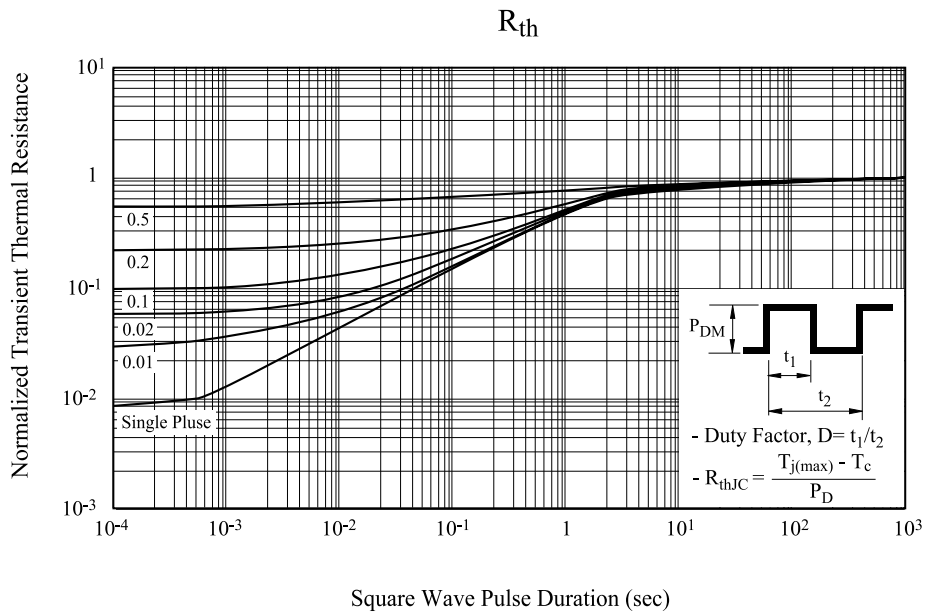
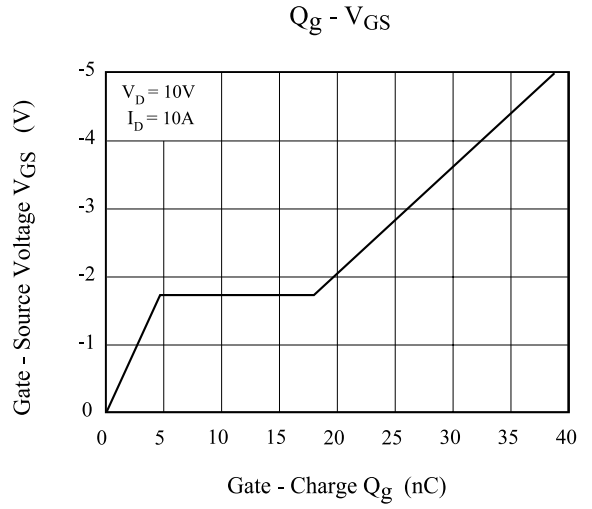
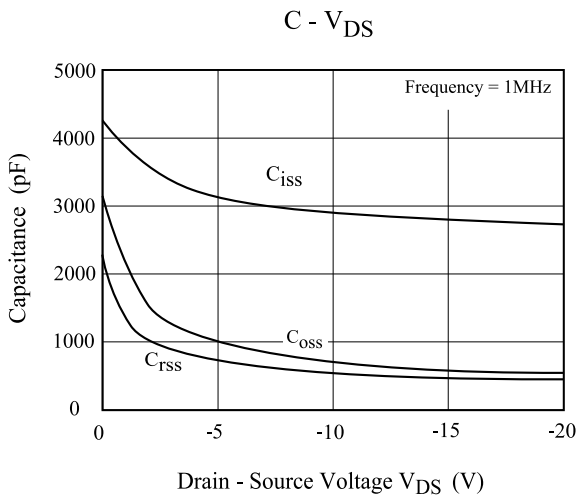

KMA010P20Q

Fig. 1 Gate Charge

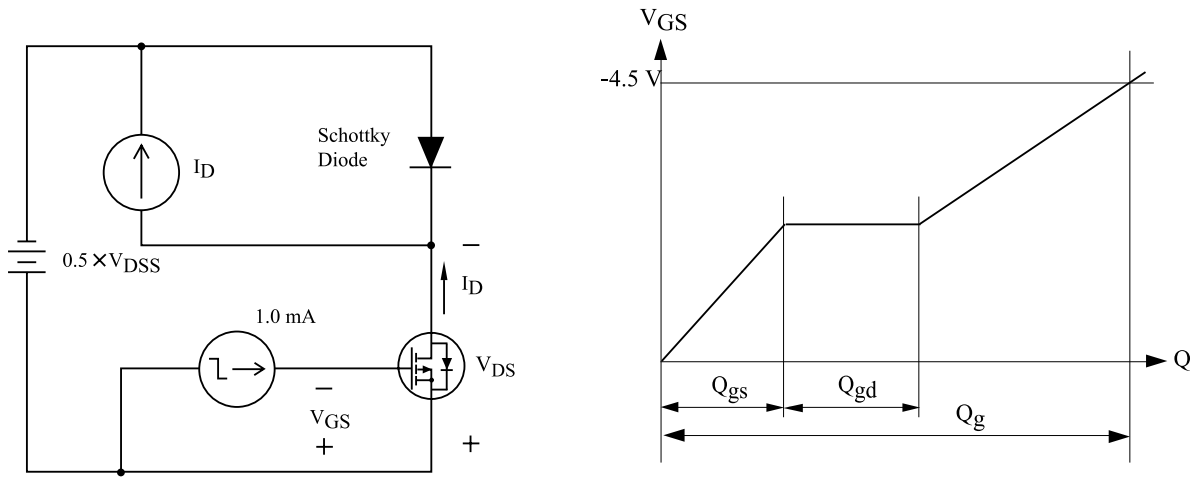

Fig. 2 Resistive Load Switching

