

### Features

1. Mini-flat package.
2. High collector-emitter voltage  
( $V_{CEO}:300V$ )
3. High current transfer ratio  
( $CTR:MIN.1000\%$  at  $I_F=1mA, V_{CE}:2V$ )
4. High isolation voltage between input and output  
( $Viso:3750V_{rms}$ ).

### Applications

1. Telephone sets.
2. Copiers, facsimiles.
3. Interfaces with various power supply circuits, power distribution boards.
4. Hybrid substrates which require high density mounting.

### Outside Dimension : Unit (mm)

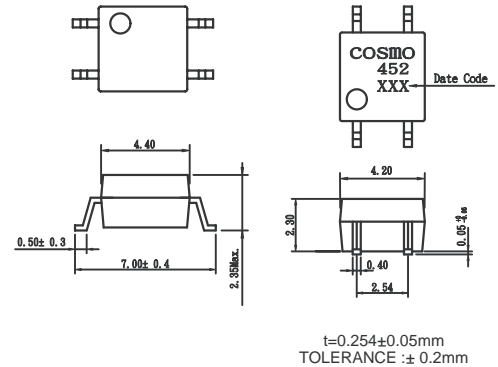

### Schematic : Top View

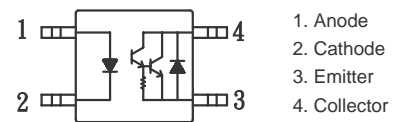

### Absolute Maximum Ratings

( $T_a=25^\circ C$ )

	Parameter	Symbol	Rating	Unit
Input	Forward current	$I_F$	50	mA
	Peak forward current	$I_{FM}$	1	A
	Reverse voltage	$V_R$	6	V
	Power dissipation	$P$	70	mW
Output	Collector-emitter voltage	$V_{CEO}$	300	V
	Emitter-collector voltage	$V_{ECO}$	0.1	V
	Collector current	$I_C$	150	mA
	Collector power dissipation	$P_C$	150	mW
	Total power dissipation	$P_{tot}$	170	mW
	Isolation voltage 1 minute	$V_{iso}$	3750	$V_{rms}$
	Operating temperature	$T_{opr}$	-30 to +100	$^\circ C$
	Storage temperature	$T_{stg}$	-40 to +125	$^\circ C$
	Soldering temperature 10 seconds	$T_{sol}$	260	$^\circ C$

### Electro-optical Characteristics

( $T_a=25^\circ C$ )

	Parameter	Symbol	Conditions	MIN.	TYP.	MAX.	Unit
Input	Forward voltage	$V_F$	$I_F=10mA$	—	1.2	1.4	V
	Reverse current	$I_R$	$V_R=4V$	—	—	10	$\mu A$
	Terminal capacitance	$C_t$	$V=0, f=1kHz$	—	30	—	pF
Output	Collector dark current	$I_{CEO}$	$V_{CE}=200V, I_F=0$	—	—	1	$\mu A$
	Collector-emitter breakdown voltage	$BV_{CEO}$	$I_C=0.1mA, I_F=0$	300	—	—	V
Transfer characteristics	Current transfer ratio	CTR	$I_F=1mA, V_{CE}=2V$	1000	—	—	%
	Collector-emitter saturation voltage	$V_{CE(sat)}$	$I_F=20mA, I_C=100mA$	—	—	1.5	V
	Isolation resistance	$R_{iso}$	DC500V, 40 TO 60%RH	$5 \times 10^{10}$	$10^{11}$	—	ohm
	Floating capacitance	$C_f$	$V=0, f=1MHZ$	—	0.6	1.0	pF
	Response time (Rise)	$t_r$	$V_{CE}=2V, I_C=20mA, R_L=100ohm$	—	100	300	$\mu s$
	Response time (Fall)	$t_f$		—	20	100	$\mu s$

**Fig.1** Forward Current vs. Ambient Temperature

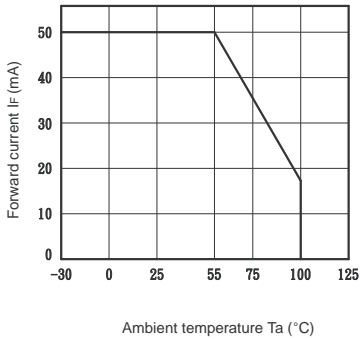

**Fig.2** Collector Power Dissipation vs. Ambient Temperature

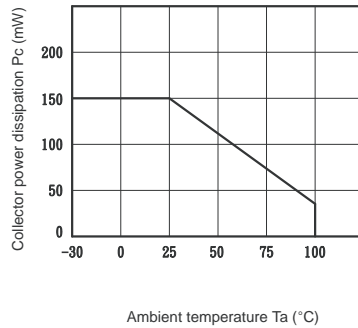

**Fig.3** Peak Forward Current vs. Duty Ratio

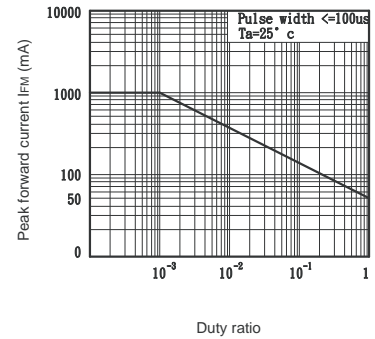

**Fig.4** Forward Current vs. Forward Voltage

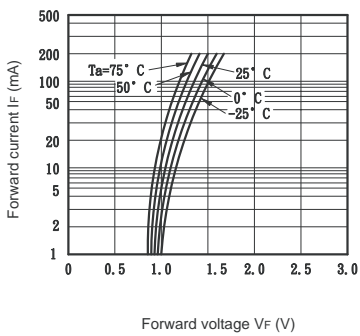

**Fig.5** Current Transfer Ratio vs. Forward Current

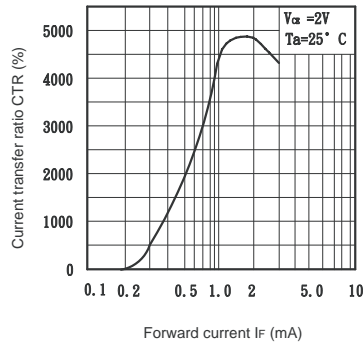

**Fig.6** Collector Current vs. Collector-emitter Voltage

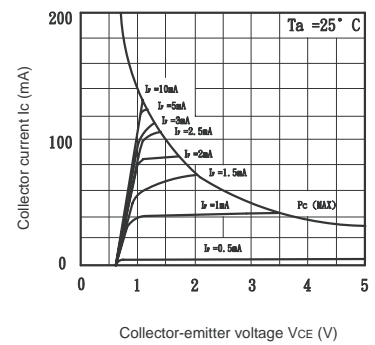

**Fig.7** Relative Current Transfer Ratio vs. Ambient Temperature

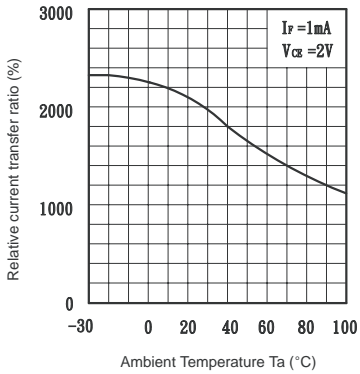

**Fig.8** Collector-emitter Saturation Voltage vs. Ambient Temperature

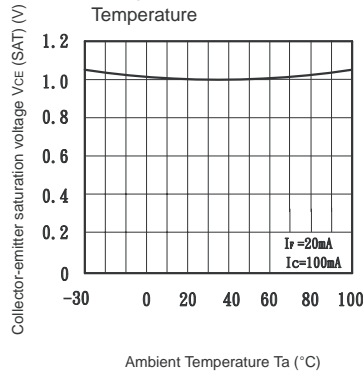

**Fig.9** Collector Dark Current vs. Ambient Temperature

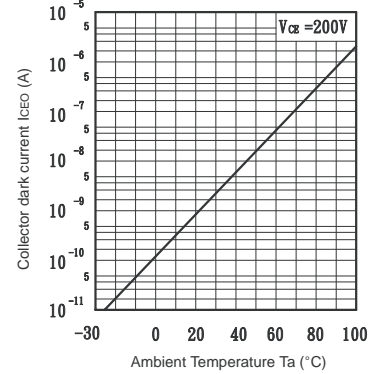

**Fig.10** Response Time vs. Load Resistance

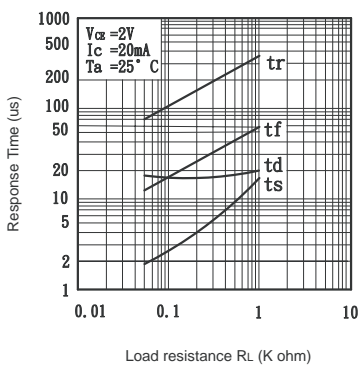

**Fig.11** Frequency Response

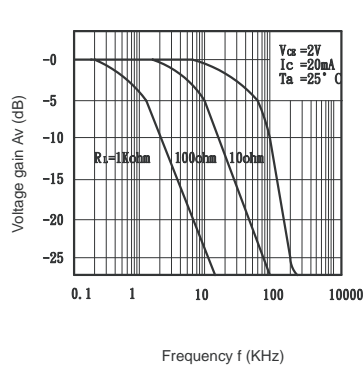

**Fig.12** Collector-emitter Saturation Voltage vs. Forward current

